

ASAHI **A**V

General Catalog (Pipe & Fittings)

ASAHI AV will not change.

—— What we have maintained since the establishment of the company in 1945. It is a "sincere attitude toward customers". We have contributed to our customers and thereby to the society by developing products that meet customers' demands for performance, including corrosion, chemical, abrasion and thermal resistances and durability, and by providing various suggestions and thorough after-sales services.

We will not stop moving forward. We will continue to respond to the trust placed in us by customers.

ASAHI AV will offer full support to our customers in the future as well.

ASAHI AV will change.

—— The technologies we have developed, the products we have produced and the trust we have gained from our customers are the sources of our pride.

However, we are not satisfied with these developments. We will be sensitive to market changes and technology advances to produce better products and thereby further contribute to the society.

As the pioneer of the industry, ASAHI AV will evolve so that we continue to be trusted and chosen by customers all over the world.

ASAHI AV



INDEX

- P.004 Pipe & Fittings Lineup
- P.006 Pipe Lineup and Standard List
- P.008 Product Features

P.011 PVC Pipe & Fittings

Unplasticized Polyvinyl Chloride Pipe

- P.012 Straight Pipe
- P.013 Bonding Socket Single-Side Straight Pipe
- P.013 Rubber Ring Socket Single-Side Straight Pipe (RR Pipe)

Tap Water Unplasticized Polyvinyl Chloride Pipe

- P.014 Straight Pipe
- P.014 Tap Water Rubber Ring Socket Single-Side Straight Pipe (RR Pipe)

Agricultural Water Service Wall-Thickness Unplasticized Polyvinyl Chloride Pipe

- P.015 Rubber Ring Socket Single-Side Straight Pipe (RR Pipe)
- P.015 Perforated Pipe

Unplasticized Polyvinyl Chloride Pipe Fitting

- P.017 Elbow
- P.017 45° Elbow
- P.017 Socket
- P.018 Reducing Socket
- P.018 Tee
- P.019 Reducing Tee
- P.019 Faucet Elbow
- P.020 Metal-Containing Faucet Elbow
- P.020 Faucet Tee
- P.021 Metal-Containing Faucet Tee
- P.021 Faucet Socket
- P.022 Metal-Containing Faucet Socket
- P.022 Valve Socket
- P.023 Union Socket
- P.023 Cap
- P.024 RR-MF Joint (Casted Product)
- P.024 AV RR-MF Joint (Bonded Product)
- P.025 FRP RR-MF Joint
<Used for Both VU and VM with Retainer>

AV Bend/Large-Size Fitting

- P.026 AV90° Bend
- P.027 AV45° Bend
- P.027 Short Elbow
- P.027 Socket
- P.028 Reducing Socket
- P.028 Tee
- P.028 Reducing Tee
- P.029 Reducing Socket (Crucial Part FRP Reinforcement Product)
- P.029 Reducing Tee (Crucial Part FRP Reinforcement Product)
- P.030 Short Flanged End
- P.030 Flanged Bend
- P.031 90°TS Normal Bend
- P.031 45°TS Normal Bend
- P.032 22½°TS Normal Bend
- P.032 11¼°TS Normal Bend
- P.032 5⅝°TS Normal Bend

Rubber Ring Hard Polyvinyl Chloride Pipe Fitting

- P.033 90° Bend
- P.033 45° Bend
- P.034 22½° Bend
- P.034 11¼° Bend
- P.034 5⅝° Bend

Flange

- P.035 TS Flange
- P.036 For U-PVC Waterworks For HI-PVC Waterworks For U-PVC ANSI Standard
- P.037 Welded Flange
- P.037 Blind Flange

Drainage Unplasticized Polyvinyl Chloride Pipe Fitting (DV Fitting)

- P.038 90° Elbow
- P.039 90° Large-Bend Elbow
- P.039 45° Elbow
- P.039 90°Y
- P.040 Reducing 90°Y
- P.040 90° Large-Bend Y
- P.040 Reducing 90° Large-Bend Y

- P.041 45°Y
- P.041 Reducing 45°Y
- P.041 90° Large-Bend Both Y
- P.042 Reducing 90° Large-bend Both Y
- P.042 Socket
- P.042 Increaser

VU Fitting

- P.043 90° Elbow
- P.043 45° Elbow
- P.044 Socket
- P.044 Increaser
- P.044 90°Y
- P.045 Reducing 90°Y
- P.045 90° Large-Bend Elbow
- P.045 45°Y
- P.046 Reducing 45°Y
- P.046 90° Large-Bend Y
- P.046 Reducing 90° Large-Bend Y

VU Large Fitting

- P.047 AV90° Elbow
- P.047 AV45° Elbow
- P.048 AV Socket
- P.048 AV90°Y

Expansion Joint/Prefab Joint

- P.049 Expansion Joint
- P.050 Prefab Joint

Multi-Joint

- P.052 Multi-Joint, TYPE L, Threaded-End Style
- P.052 Multi-Joint, TYPE T, Threaded-End Style
- P.053 Multi-Joint, TYPE L, TS-Style
- P.054 Multi-Joint, TYPE T, TS-Style

Technical Document

- P.055 Technical Document
- P.057 Installation Procedure
- P.059 Package List
- P.063 For Safety Use

P.065 C-PVC Pipe & Fittings

- P.066 Straight Pipe (C-PVC Pipe)
- P.068 Elbow
- P.069 45° Elbow/Bend
- P.070 Socket
- P.071 Reducing Socket
- P.072 Tee
- P.073 Faucet Socket (TYPE A)
(Metal Insert contained)
- P.074 Faucet Elbow (TYPE A)
(Metal Insert contained)
- P.074 Valve Socket with Metal Male Thread (TYPE A)
- P.075 Expansion Joint
- P.076 Prefab Joint
- P.077 TS Flange
- P.077 Welding Rod

Technical Document

- P.078 Technical Document
- P.079 Package List
- P.080 Installation Procedure
- P.081 Precautions
- P.083 For Safety Use

P.085 High Purity Pipe & Fittings

- P.086 Straight Pipe (VP)
- P.089 Elbow
- P.089 45° Elbow
- P.089 45° Bend
- P.090 Socket
- P.090 Reducing Socket
- P.091 Tee
- P.091 Reducing Tee
- P.092 Faucet Elbow
- P.093 Faucet Socket
- P.093 Valve Socket
- P.094 Cap
- P.094 AV45° Bend
- P.095 Elbow (L)
- P.095 Socket
- P.096 Reducing Socket
- P.096 Tee
- P.097 Reducing Tee
- P.098 TS Flange
- P.098 Blind Flange
- P.099 Prefab Joint
- P.101 Multi-Joint, TYPE L, Threaded-End Style
- P.101 Multi-Joint, TYPE T, Threaded-End Style
- P.102 Multi-Joint, TYPE L, TS-Style
- P.103 Multi-Joint, TYPE T, TS-Style
- P.104 Joint Equipment

Technical Document

- P.105 For Safety Use

P.107 Chemical Pipe

- P.108 Straight Pipe (Chemical Pipe)

Technical Document

- P.109 Technical Document

P.111 AV Pipe & Fittings

- P.112 Product Type/Prefabricated Product
- P.113 Straight Pipe
- P.113 Single-Side Sleeve
- P.114 Elbow, Bend (90°)
- P.115 Elbow, Bend (45°)
- P.115 Tee
- P.116 Reducing Tee
- P.117 Socket
- P.117 Reducing Socket
- P.118 TS Flange (JIS 10K Type)
- P.118 Blind Flange (JIS 10K Type)

Technical Document

- P.119 Installation Procedure
- P.120 Piping Support Procedure
- P.121 Maintenance Material
- P.122 Piping Support Hardware

P.123 Double Contained Pipe & Fittings

- P.124 Overview of Double Contained Pipe
- P.125 Features and Structure
- P.126 Lineup and Piping Example
- P.128 Pipe
- P.128 Pipe (For Inner Pipe Fixing)
- P.129 Elastic Slide Pipe
- P.130 Elbow
- P.130 Elbow (With Drain)
- P.130 Tee
- P.131 Tee (With Drain)
- P.131 End Cap
- P.131 Splash Panel
- P.132 Thermal Pipe & Fittings

Technical Document

- P.133 Technical Document
- P.140 Handling Precautions

P.141 PP Pipe & Fittings

Pipe & Fittings

- P.142 Straight Pipe
- P.143 Socket Common Dimensions
- P.144 Socket
- P.144 90° Elbow
- P.145 45° Elbow
- P.145 Tee (Same Diameter)
- P.146 Reducer (Bush-Type)
- P.147 End Cap

- P.147 Male Threaded Adaptor (Spigot)
- P.147 Female Threaded Adaptor (Spigot)
- P.148 90° Bend (Spigot)
- P.148 45° Elbow (Spigot)
- P.148 Same Diameter Tee (Spigot)
- P.149 Reducing Tee (Spigot)
- P.149 Reducer (Spigot)
- P.150 Flange Adaptor (Spigot)
- P.150 Backing Flange (For Spigot)
- P.151 End Cap (Spigot)
- P.151 Male Threaded Adaptor (Spigot)
- P.151 Female Threaded Adaptor (Spigot)
- P.152 Flange Adaptor (Socket)
- P.153 Socket Flange
- P.153 Backing Flange (For Socket)

Flange

- P.154 Welded/Blind Flange

EF Socket

- P.154 EF Socket

Welding Rod

- P.155 Welding Rod

Prefab Joint

- P.155 Prefab Joint (21 Type)
DIN Socket End
- P.156 Prefab Joint (Spigot)
- P.156 Prefab Joint

IAM LOCK

- P.157 IAM LOCK

Technical Document

- P.158 Technical Document
- P.166 Installation Procedure

P.175 Related Products

- P.176 Full-Face Gasket (JIS 10K, JIS 5K)
- P.177 Full-Face Gasket (DIN, ANSI)
- P.178 Inner-Face Gasket
- P.179 AV PTFE/PVDF Gasket
- P.180 Viflon®
- P.181 AV Bellmouth
- P.182 FRP Opening/Closing Base
- P.183 Gauge Flange
- P.184 AV Gauge Flange
- P.185 AV Diaphragm Type Pressure Gauge
- P.186 Bolt/Nut/Washer
- P.188 Saddle
- P.189 AV Cement
- P.190 AV Lubricant
- P.191 Air-Conditioning Drain Pipe &
Fittings · Saddle Band

Technical Document

- P.193 For Safety Use

-
- P.196 Warranty & Requests for Export

PVC Pipe & Fittings

P.011

For General/Tap Water/Agricultural Water Service (U-PVC, HI-PVC)

JIS / JWWA / JPPFA / AV

Pipe made of vinyl chloride with excellent corrosion resistance

General



C-PVC Pipe & Fittings

P.065

(Heat-Resistant C-PVC)

JIS / AV

Pipe made of thermal-resistant vinyl chloride having excellent resistance to corrosion and high temperatures

Heat-Resistant



High Purity Pipe & Fittings

P.085

(High Purity U-PVC)

Pipe made of vinyl chloride with excellent corrosion resistance suitable for high purity water line facilities

Precision



AV Pipe & Fittings

P.111

(PVC+FRP Double Laminated Fittings, PP+FRP Double Laminated Fittings)

Applicable for high temperature and high pressure conditions by reinforcing vinyl chloride pipe or polypropylene pipe with FRP

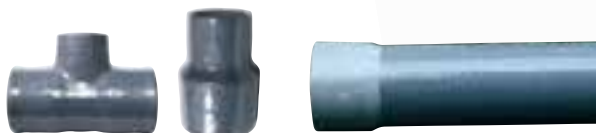

Strong



ASAHI

Pipe & Fittings

Material	Characteristics
U-PVC	The most standard PVC with excellent chemical and physical characteristics.
HI-PVC	A material still maintaining the excellent characteristics of PVC with improved impact-resistance. A material originally made as a countermeasure against the water hammer pressure for tap water piping materials.
C-PVC	A material still maintaining the excellent characteristics of PVC with improved heat-resistance to 90°C.
PP	Has a small specific gravity and excellent water-resistance, electric insulation capability and dynamic/mechanical characteristics in high temperatures. Cannot be bonded as PVC but has an excellent chemical-resistant balance.
PVDF	Highly strong and impact-resistant. Although usage is limited to alkali and some solvents, the chemical-resistance against other chemicals exceeds PVC and PP. Used in the temperature between -40 and 120°C and has an excellent wear-resistance and electrostatic property. Gas-barrier is superior than PTFE.

IAV

Lineup



Chemical Pipe

(U-PVC)

P.107

Pipe with excellent chemical-resistance, high pressure-resistance and long-term durability



Double Contained Pipe & Fittings

(U-PVC, HI-PVC)

P.123

Detects leakage point and prevents fluid from scattering to outside



PP Pipe & Fittings

(PP)

P.141

DIN Environment-friendly clean material (generates no dioxin when burnt) with excellent corrosion- and heat-resistance

Ecology



Related Products

P.175

Related product

ASAHI Pipe Lineup and Standard List

Usage	Product Name	Material	Connection	Type	Maximum Working Temperature	Maximum Working Pressure *2	13	16 (15)	20		
								1/2	3/4		
General Use General Use PVC Pipe	Unplasticized Polyvinyl Chloride Pipe	U-PVC	Straight Pipe	VP	60°C	1.0MPa	6741	6741	6741		
				VU	60°C	0.6MPa					
			Bonding Socket	VP	60°C	1.0MPa					
				VU	60°C	0.6MPa					
			Rubber Ring Socket	VP	Normal Temperature *1	1.0MPa					
				VM	Normal Temperature *1	0.8MPa					
	VU	Normal Temperature *1	0.6MPa								
		HI-PVC	Straight Pipe	HIVP	60°C	1.0MPa	6741	6741	6741		
		Agricultural Water Service Wall-Thickness Unplasticized Polyvinyl Chloride Pipe	U-PVC	Rubber Ring Socket	VH	Normal Temperature *1	1.25MPa				
		Tap Water Unplasticized Polyvinyl Chloride Pipe	U-PVC	Straight Pipe	VP	Normal Temperature *1	0.75MPa	6742	6742	6742	
	VP				Normal Temperature *1	0.75MPa					
	Rubber Ring Socket		HI-PVC	Straight Pipe	HIVP	Normal Temperature *1	0.75MPa	6742	6742	6742	
				Rubber Ring Socket	HIVP	Normal Temperature *1	0.75MPa				
		High Purity Resistance Polyvinyl Chloride Pipe (HP-PVC)	U-PVC (High Purity PVC)	Straight Pipe	VP	50°C	1.0MPa				
	Perforated Pipe	U-PVC	Bonding Socket	VP	Normal Temperature *1	—					
VU				Normal Temperature *1	—						
	Air-Conditioning Drain Pipe	U-PVC	Straight Pipe	VP	Normal Temperature *1	—					
(VU)				Normal Temperature *1	—						
Heat-Resistant PVC Pipe	C-PVC Pipe	C-PVC	Straight Pipe	HT	90°C	1.0MPa	6776	6776	6776		
Strong FRP Double Laminated Fitting	AV Pipe	U-PVC (FRP Reinforcement)	Straight Pipe or Bonding Socket	SU type	90°C						
				High Purity Type	95°C						
				GU Type	95°C						
				GU-N Type	95°C						
		PP (FRP Reinforcement)		PP Type	100°C						
Ecology Corrosion- and Heat-Resistant Polypropylene	PP Pipe	PP	Straight Pipe	PP-Socket	90°C	1.0MPa		PN10	PN10		
				PP-Spigot	90°C	1.0MPa		PN10	PN10		
Chemical Resistant PVC Pipe	Chemical Pipe	U-PVC (Chemical)	Straight Pipe	VP	60°C	1.0MPa					
Safeguard Chemical Scattering Prevention	Double Contained Pipe	Inner Pipe (Reference) Outer Pipe (Reference)	Straight Pipe (Inside/Outside)	Inner Pipe (VP) Outer Pipe (VU)				Inner Pipe x Outer Pipe 16x65	20x65		

6741 : JIS K6741 Unplasticized Polyvinyl Chloride Pipe
6742 : JIS K6742 Tap Water Unplasticized Polyvinyl Chloride Pipe
6776 : JIS K6776 Heat-Resistant Unplasticized Polyvinyl Chloride Pipe
K127 : JWWA K127 Tap Water Rubber Ring Unplasticized Polyvinyl Chloride Pipe
K129 : JWWA K129 Tap Water Rubber Ring Impact-Resistant Unplasticized Polyvinyl Chloride Pipe

AS13 : JPPFA AS13 Perforated Unplasticized Polyvinyl Chloride Pipe
AS20 : JPPFA AS20 Tap Water Unplasticized Polyvinyl Chloride Pipe
AS33 : JPPFA AS33 Tap Water Rubber Ring Unplasticized Polyvinyl Chloride Pipe
AS60 : JPPFA AS60 Agricultural Water Service Wall-Thickness Unplasticized Polyvinyl Chloride Pipe

Size (mm/inch)																	
25	30	40	50	65	75 (80)	100	125	150	200	250	300	350	400	450	500	600	
1		1 1/2	2	2 1/2	3	4	5	6	8	10	12	14	16	18	20	24	
6741	6741	6741	6741	6741	6741	6741	6741	6741	6741	6741	6741						
		6741	6741	6741	6741	6741	6741	6741	6741	6741	6741	6741	6741	6741	6741		
					6741	6741	6741	6741	6741	6741	6741						
					6741	6741	6741	6741	6741	6741	6741	6741	6741	6741	6741	6741	
			6741		6741	6741	6741	6741	6741	6741	6741						
												6741	6741	6741	6741		
					6741	6741	6741	6741	6741	6741	6741	6741	6741	6741	6741	6741	
6741	6741	6741	6741	6741	6741	6741	6741	6741									
			AS60		AS60	AS60		AS60									
6742	6742	6742	6742	AS20	6742	6742	AS20	6742	AS20	AS20	AS20						
			K129		K129	K129	AS33	K129	AS33	AS33	AS33						
6742	6742	6742	6742	AS20	6742	6742	AS20	6742	AS20	AS20	AS20						
			K129		K129	K129	AS33	K129	AS33	AS33	AS33						
			AS13	AS13	AS13	AS13	AS13	AS13	AS13	AS13	AS13						
			AS13	AS13	AS13	AS13	AS13	AS13	AS13	AS13	AS13	AS13	AS13	AS13	AS13	AS13	
6776	6776	6776	6776														
PN10	PN10	PN10	PN10	PN10	PN10	PN10	PN10	PN10 PN4	PN10 PN4	PN10 PN4							
PN10	PN10	PN10	PN10	PN10	PN10	PN10	PN10	PN10	PN10	PN10							
25x75		40x75	50x100	65x125	75x150	100x200	125x250	150x250									

*1 Normal temperature is 20±15°C.

*2 Maximum working pressure is a value at 20°C.

 Our Product Lineup: Products without a standard number conform to the AV standard (manufacturers' standard products).

PVC Pipe & Fittings

- 1 Excellent corrosion resistance and no need to worry about corrosion.
- 2 Great mechanical strength with its elasticity.
- 3 Excellent weather resistance and suffers less from alterations such as deformation, discoloration and deterioration.
- 4 Flow resistance and friction coefficient are low.
- 5 No need to worry about electric leakage as it is insulated.
- 6 Hygienic because of unplasticized polyvinyl chloride.
- 7 No self-combustion ability with excellent self-extinguishing ability.
- 8 Easy to handle because of the weight being 1/6 of iron and 1/2 of aluminum and can be easily connected by the TS method.
- 9 Price and installation cost are low and it is economical due to the semipermanent characteristic.



Usage	Chemical Piping	▶ Chemical/iron-making/nonferrous refining/power generating facilities, various facilities
	Water Supply/Discharge/Waste Water Piping	▶ Buildings, plants, public facilities
	Industrial Water Piping	▶ Plants, various facilities
	Sea/Fresh Water Piping	▶ Aquariums, culture farms, sea/fresh water facilities
	Agricultural Water Service Piping	▶ Public pipelines, facilities
	Air-Conditioning Piping	▶ Plants, public facilities

AV Pipe & Fittings

- 1 Excellent chemical resistance and applicable to various plants.
- 2 Compression strength is increased by reinforcing the perimeter with FRP and it has great impact-resistance.
- 3 Can be used in high heat for a long period of time.
- 4 Can be used under a corrosive environment. No need to worry about corrosion as it is fully insulated.
- 5 Linear expansion coefficient is small as U-PVC and FRP are strongly bonded together by a special technology.
- 6 Far more lighter than metal pipes so piping at a high place is easy. The joint part is FRP lamination so that connection is easy by the TS method.



Usage	Chemical Piping	▶ Alkali lines for electrolysis plants, acid washing lines for iron-making plants
	Exhaust Gas Piping (Duct)	▶ Exhaust gas lines for chemical/pharmaceutical plants
	Pure Water Piping	▶ Pure water lines for semiconductor/liquid crystal plants
	Sea/Fresh Water Piping	▶ Sea water facilities, desalination devices
	Warm Water Piping	▶ Spa/various facilities

AV Pipe Structure

Unplasticized Polyvinyl Chloride Pipe (Special Product)	Surface Treatment Part	Special Primer	FRP Layer (Fiber Reinforcement Plastics)	Surface Finishing Layer
Residual stress inside pipe is uniquely removed.	A special surface treatment to enhance the adhesion effect of primer.	Unplasticized polyvinyl chloride pipe and FRP layer are bonded.	A reinforcement layer laminated by glass layers impregnated with polyester resin.	Finished with corrosion-resistant polyester resin.

C-PVC Pipe & Fittings

- 1 Applicable to high-heat fluid of 90°C.
- 2 Excellent chemical-resistance.
- 3 Excellent corrosion resistance and no need to worry about corrosion.
- 4 No need to worry about electric leakage as it is insulated.
- 5 Easy to handle because of the weight being 1/6 of iron and 1/2 of aluminum and can be easily connected by the TS method.
- 6 Price and installation cost are low and it is economical due to semipermanent.

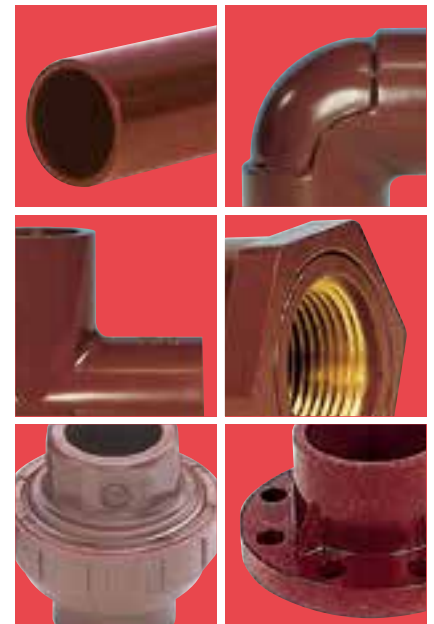

Usage	Chemical Piping	▶ Chemical/iron-making/nonferrous refining/power generating facilities, various facilities
	Air-Conditioning/Heater Piping	▶ Plants, various facilities
	Hot Spring Piping	▶ Spa/various facilities
	Household Hot-Water Supply (Lead-Free Blend) Piping	▶ Spa/various facilities



Multi-Joint (U-PVC, High Purity PVC)

- 1 Highly safe with the unique cast technology.
- 2 A wide variety of product lineup.
- 3 Has a compact design and strong mechanical strength with the optimal design expecting the use under a severe condition.
- 4 Excellent durability that has passed the unique and harsh long-term test and pressure test.
- 5 High Purity PVC with corrosion-resistance and low dissolving ability is used and applicable for degrease (Lubricant Free) cleaning.

Usage	Pure Water Piping	▶ Pure water lines for semiconductor/liquid crystal plants
	Chemical Solution Device Piping	▶ Chemical solution devices/facilities

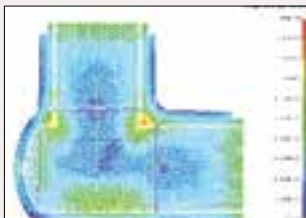

Use Example



Installation of various sensors such as pressure gauge and thermometer.



Installation of valves and cocks for sampling and draining.



Compact pipeline with reduced diameter.

<Use precautions>

When installing various components of sensors, etc. to the threaded part, wrap seal tape 2 to 3 times on the component, press it tightly with hand, and then tighten it by turning 1/4 to 1/2 with a wrench. Beware not to deform or damage the threaded part when installing and removing various components. Do not place abnormal stress such as impact on the threaded part when using.

High Purity Pipe & Fittings

- 1 Low dissolution.
- 2 Great mechanical strength with its elasticity.
- 3 Inner face is flat and mirror surface.
- 4 A structure with minimized dead space where liquid stagnates.
- 5 Can be used for degreasing (detergent product) and high-temperature pasteurization high purity water lines.
- 6 Easy connection by the TS method.

Usage **Pure Water Piping** ▶ Pure water lines for semiconductor/liquid crystal plants



Chemical Pipe

- 1 Enhanced chemical-resistance and excellent penetration resistance against hydrochloric acid, fluorine, etc.
- 2 Long-term durability (high creep property).
- 3 Highly safe and reliable with the high pressure-resistant capability.

Usage **Chemical Piping** ▶ Chemical/iron-making/nonferrous refining/power generating facilities, various facilities
Water Supply/Discharge/Waste Water Piping ▶ Buildings, plants, public facilities
Industrial Water Piping ▶ Plants, various facilities
Sea/Fresh Water Piping ▶ Aquariums, culture farms, spa facilities
Agricultural Water Service Piping ▶ Public pipelines, facilities
Air-Conditioning Piping ▶ Plants, public facilities

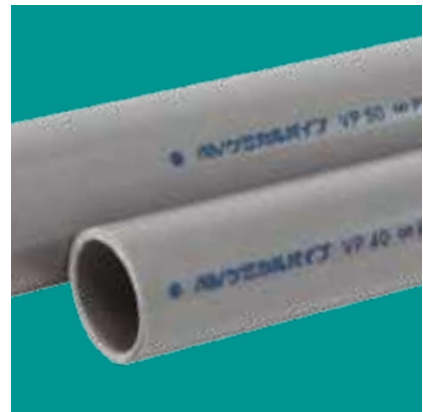

Double Contained Pipe & Fittings

- 1 Dual design that prevents outflow to outside even when chemical solution is leaked when the inner pipe ruptures and withstands the full capacity with the outer pipe.
- 2 Transparent PVC is used for the outer pipe to enable visual inspection.
- 3 Difference of expansion/contraction amount due to the outside temperature of the outer pipe and the fluid temperature of the inner pipe is resolved by our unique slide pipe function.

Usage **Chemical Piping** ▶ Chemical/iron-making/nonferrous refining/power generating facilities, various facilities

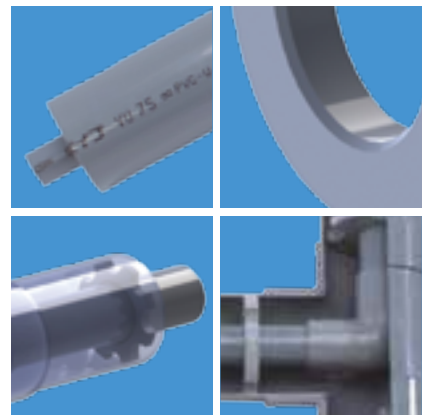

PP Pipe & Fittings

- 1 Excellent chemical-resistance, strong against acid and alkali and no need to worry about corrosion.
- 2 Extremely strong against heat and can be used for fluid up to 90°C.
- 3 Low dissolution and hygienic.
- 4 Installation is also simple with 1/9 of iron weight. Easy cutting and fusing on site.
- 5 Environment-friendly as it generates no dioxin when burnt.

Usage **Chemical Piping** ▶ Alkali lines for electrolysis plants, acid washing lines for iron-making plants
Exhaust Gas Piping (Duct) ▶ Exhaust gas lines for chemical/pharmaceutical plants
Pure Water Piping ▶ Pure water lines for semiconductor/liquid crystal plants
Food Plant Piping ▶ Supply/discharge pipes inside food plants
Supply/Discharge Piping ▶ Food plants/facilities
Warm Water Piping ▶ Spa/various facilities
Others, Warm Water Piping



PVC Pipe & Fittings

Unplasticized Polyvinyl Chloride Pipe	P.012
Tap Water Unplasticized Polyvinyl Chloride Pipe	P.014
Agricultural Water Service Wall-Thickness Unplasticized Polyvinyl Chloride Pipe	P.015
Unplasticized Polyvinyl Chloride Pipe Fitting	P.016
AV Bend/Large-Size Fitting	P.026
Rubber Ring Hard Polyvinyl Chloride Pipe Fitting	P.033
Flange	P.035
Unplasticized Polyvinyl Chloride Pipe Fitting (DV Fitting)	P.038
VU Fitting	P.043
VU Large Fitting	P.047
Expansion Joint/Prefab Joint	P.049
Multi-Joint	P.051
Technical Document	P.055

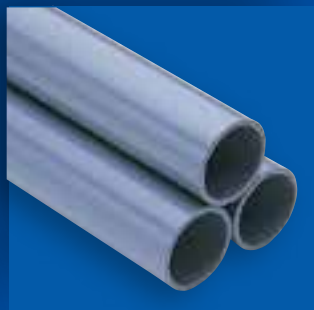

General

PRODUCT MODEL CODE LIST

Type	Field	Material	Standard/Wall Thickness	Standard	Type	Size	Length
P	N	*	**	*	*	***	**
⋮	⋮	⋮	⋮	⋮	⋮	⋮	⋮
P Pipe	N Standard	U U-PVC I HI-PVC	PP Straight Pipe VP UP Straight Pipe VU P5 Bonding Socket VP U5 Bonding Socket VU P7 Rubber Ring Socket VP M1 Rubber Ring Socket VM U1 Rubber Ring Socket VU WP Tap Water Straight Pipe W7 Tap Water Rubber Ring Socket H7 Rubber Ring Socket VH P6 Perforated Pipe VP U6 Perforated Pipe VU	J JIS V AV	N Standard U Perforated Pipe	013 13 mm I 500 500 mm	04 4m 05 5m

Straight Pipe

Abbreviation: VP VU HIVP Unplasticized Polyvinyl Chloride Pipe (JIS K 6741)



VP, VU
U-PVC



HIVP
HI-PVC

Maximum Working Pressure (Normal Temperature)

VP	1.0MPa
VU	0.6MPa
HIVP	1.0MPa

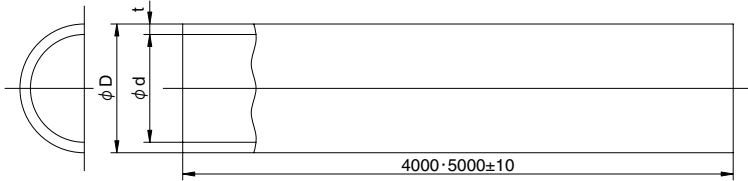

Dimensions Table

(Unit: mm)

Size	VP	VU	HI VP	VP • HIVP						VU								
				D (Outer Diameter)			t (Thickness)		d	Weight per 1m (Reference) (kg)		D (Outer Diameter)			t (Thickness)		d	Weight per 1m (Reference) (kg)
				Basic Dimension	Max/Min. Outer Dimensional Tolerance	Average Outer Dimensional Tolerance	Min Dimension	Tolerance		Approximate Inner Diameter	VP	HI-VP	Basic Dimension	Average Outer Dimensional Tolerance	Min Dimension	Tolerance		
									Dimension								Tolerance	Dimension
40	○	○	—	48	±0.3	±0.2	3.6	+0.8	40	0.791	—	48	±0.2	1.8	+0.4	44	0.413	
50	○	○	—	60	±0.4	±0.2	4.1	+0.8	51	1.122	—	60	±0.2	1.8	+0.4	56	0.521	
65	○	○	—	76	±0.5	±0.3	4.1	+0.8	67	1.445	—	76	±0.3	2.2	+0.6	71	0.825	
75	○	○	—	89	±0.5	±0.3	5.5	+0.8	77	2.202	—	89	±0.3	2.7	+0.6	83	1.159	
100	○	○	—	114	±0.6	±0.4	6.6	+1.0	100	3.409	—	114	±0.4	3.1	+0.8	107	1.737	
125	○	○	—	140	±0.8	±0.5	7.0	+1.0	125	4.464	—	140	±0.5	4.1	+0.8	131	2.739	
150	○	○	—	165	±1.0	±0.5	8.9	+1.4	146	6.701	—	165	±0.5	5.1	+0.8	154	3.941	
200	○	○	□	216	±1.3	±0.7	10.3	+1.4	194	10.129	9.913	216	±0.7	6.5	+1.0	202	6.572	
250	○	○	□	267	±1.6	±0.9	12.7	+1.8	240	15.481	15.052	267	±0.9	7.8	+1.2	250	9.758	
300	○	○	□	318	±1.9	±1.0	15.1	+2.2	286	21.962	21.252	318	±1.0	9.2	+1.4	298	13.701	
350	—	○	—	—	—	—	—	—	—	—	—	370	±1.2	10.5	+1.4	348	18.051	
400	—	○	—	—	—	—	—	—	—	—	—	420	±1.3	11.8	+1.6	395	23.059	
450	—	○	—	—	—	—	—	—	—	—	—	470	±1.5	13.2	+1.8	442	28.875	
500	—	○	—	—	—	—	—	—	—	—	—	520	±1.6	14.6	+2.0	489	35.346	

(Note) 1. ○ are accordance with JIS K 6741. 2. □ conform to the AV standard.

Bonding Socket Single-Side Straight Pipe

Abbreviation: **VP** **VU**

Unplasticized Polyvinyl Chloride Pipe (JIS K 6741)

PRODUCT MODEL CODE

VP ▶ P N U P5 J N Size Length
VU ▶ P N U U5 J N Size Length



VP, VU
U-PVC

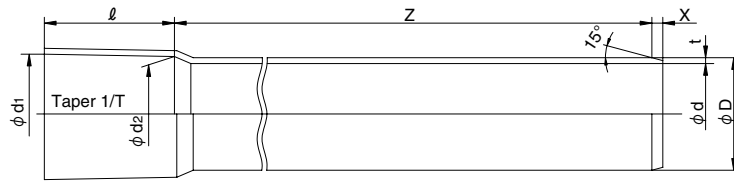

Maximum Working Pressure (Normal Temperature)	
VP	1.0MPa
VU	0.6MPa

Dimensions Table

(Unit: mm)

Size	Common						VP			VU		
	d ₁	d ₂	l	Taper 1/T	D	Z	d	t	X (Reference)	d	t	X (Reference)
○ 40	48.7 ±0.3	47.21	55 ⁺⁴ _{-0.5}	1/37	48 ±0.2	4000 ±15	40	3.6 +0.8	8	—	—	—
○ 50	60.8 ±0.3	59.10	63 ⁺⁴ _{-0.5}	1/37	60 ±0.2	4000 ±15	51	4.1 +0.8	9	56	1.8 +0.4	4
○ 65	76.6 ±0.3	75.33	61 ⁺⁴ _{-0.5}	1/48	76 ±0.2	4000 ±15	67	4.1 +0.8	9	71	2.2 +0.6	5
75	89.6 ±0.3	88.3 ±0.3	64 ⁺⁵ ₀	1/49	89 ±0.3	4000 ±15	77	5.5 +0.8	12	83	2.7 +0.6	6
100	114.7 ±0.3	113.2 ±0.3	84 ⁺⁵ ₀	1/56	114 ±0.4	4000 ±15	100	6.6 +1.0	14	107	3.1 +0.8	7
125	140.9 ±0.4	139.1 ±0.4	104 ⁺⁵ ₀	1/58	140 ±0.5	4000 ±15	125	7.0 +1.0	15	131	4.1 +0.8	9
150	166.0 ±0.5	163.9 ±0.5	132 ⁺⁵ ₀	1/63	165 ±0.5	4000 ±15	146	8.9 +1.4	19	154	5.1 +0.8	11
200	217.9 ±0.8	213.9 ±0.8	200 ⁺¹⁰ ₀	1/50	216 ±0.7	4000 ±15	194	10.3 +1.4	22	202	6.5 +1.0	14
250	269.3 ±0.9	264.3 ±0.9	250 ⁺¹⁰ ₀	1/50	267 ±0.9	4000 ±15	240	12.7 +1.8	27	250	7.8 +1.2	17
300	320.7 ±1.0	314.7 ±1.0	300 ⁺¹⁰ ₀	1/50	318 ±1.0	4000 ±15	286	15.1 +2.2	32	298	9.2 +1.4	20
350	373.1 ±1.0	366.1 ±1.0	350 ⁺¹⁰ ₀	1/50	370 ±1.2	4000 ±15	—	—	—	348	10.5 +1.4	22
400	423.6 ±1.2	415.6 ±1.2	400 ⁺¹⁰ ₀	1/50	420 ±1.3	4000 ±15	—	—	—	395	11.8 +1.6	25
450	474.0 ±1.2	465.0 ±1.2	450 ⁺¹⁰ ₀	1/50	470 ±1.5	4000 ±15	—	—	—	442	13.2 +1.8	28
500	524.5 ±1.3	514.5 ±1.3	500 ⁺¹⁰ ₀	1/50	520 ±1.6	4000 ±15	—	—	—	489	14.6 +2.0	31

Notes: 1. Taper 1/T for 75 to 500 mm are reference value. 2. d₂ dimension for 40 to 65 mm are reference value. 3. ○ are accordance with JIS K 6741.

Rubber Ring Single-Side Socket Straight Pipe (RR Pipe)

Abbreviation: **VP** **VM** **VU**

Unplasticized Polyvinyl Chloride Pipe (JIS K 6741)

PRODUCT MODEL CODE

VP ▶ P N U P7 J N Size Length
VM ▶ P N U M1 J N Size Length
VU ▶ P N I U1 J N Size Length



VP, VM, VU
U-PVC

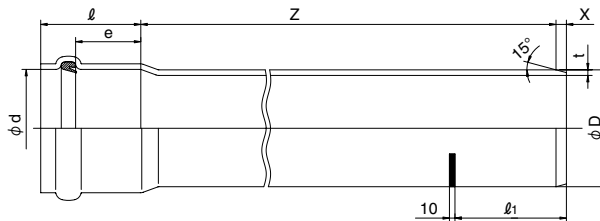

Maximum Working Pressure (Normal Temperature)	
VP	1.0MPa
VM	0.8MPa
VU	0.6MPa

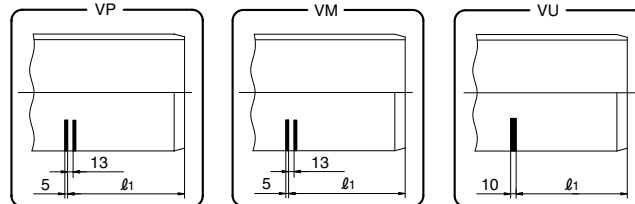

Dimensions Table

(Unit: mm)

Size	Common				VP				VM				VU			
	d (Min.)	e (Min.)	l (Max.)	D	Z	t	X (Reference)	l ₁	Z	t	X (Reference)	l ₁ (Reference)	Z	t	X (Reference)	l ₁ (Reference)
50	60.3	58	115	60±0.2	5000 ±15	4.1 +0.8	8	107 +5	—	—	—	—	—	—	—	—
75	89.5	61	130	89±0.3	5000 ±15	5.5 +0.8	11	120 +5	—	—	—	—	4000	2.7 +0.6	6	131
100	114.5	64	145	114±0.4	5000 ±15	6.6 +1.0	13	132 +5	—	—	—	—	4000	3.1 +0.8	7	144
125	140.6	67	150	140±0.5	5000 ±15	7.0 +1.0	14	138 +5	—	—	—	—	4000	4.1 +0.8	9	154
150	165.7	70	165	165±0.5	5000 ±15	8.9 +1.4	18	152 +5	—	—	—	—	4000	5.1 +0.8	11	167
200	216.9	76	190	216±0.7	5000 ±15	10.3 +1.4	21	179 +5	—	—	—	—	4000	6.5 +1.0	14	184
250	268.1	82	210	267±0.9	5000 ±15	12.7 +1.8	25	197 +5	—	—	—	—	4000	7.8 +1.2	17	202
300	319.3	88	235	318±1.0	5000 ±15	15.1 +2.2	30	217 +5	—	—	—	—	4000	9.2 +1.4	20	220
350	371.5	89	245	370±1.2	—	—	—	—	4000	14.3 +2.0	27	231	4000	10.5 +1.4	22	242
400	421.7	91	265	420±1.3	—	—	—	—	4000	16.2 +2.2	30	244	4000	11.8 +1.6	25	260
450	471.9	94	290	470±1.5	—	—	—	—	4000	18.1 +2.6	34	263	4000	13.2 +1.8	28	283
500	522.1	96	305	520±1.6	—	—	—	—	4000	20.0 +2.8	37	276	4000	14.6 +2.0	31	306

Straight Pipe

Abbreviation: **VPW** **HIVPW** Tap Water Unplasticized Polyvinyl Chloride Pipe (JIS K 6742)



VPW
U-PVC



HIVPW
HI-PVC

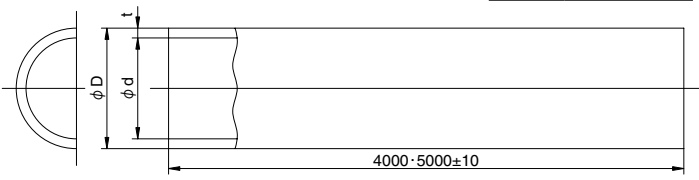

Maximum Working Pressure
(Hydrostatic pressure)

VPW
HIVPW 0.75MPa

Dimensions Table

Size	Outer Diameter			Thickness		Overall Length		Reference Weight per 1m (kg/m)	
	Basic Dimension	Max/Min. Tolerance	Average Tolerance	Basic Dimension	Tolerance			VPW	HIVPW
13	18.0	±0.2	±0.2	2.5	±0.2	4000	—	0.174	0.170
16	22.0	±0.2	±0.2	3.0	±0.3	4000	—	0.256	0.251
20	26.0	±0.2	±0.2	3.0	±0.3	4000	—	0.310	0.303
25	32.0	±0.2	±0.2	3.5	±0.3	4000	—	0.448	0.439
30	38.0	±0.3	±0.2	3.5	±0.3	4000	—	0.542	0.531
40	48.0	±0.3	±0.2	4.0	±0.3	4000	5000	0.791	0.774
50	60.0	±0.4	±0.2	4.5	±0.4	4000	5000	1.122	1.098
● 65	76.0	±0.5	±0.2	4.5	±0.4	4000	5000	1.445	1.415
75	89.0	±0.5	±0.2	5.9	±0.4	4000	5000	2.202	2.156
100	114.0	±0.6	±0.2	7.1	±0.5	4000	5000	3.409	3.338
● 125	140.0	±0.8	±0.3	7.5	±0.5	4000	5000	4.464	4.370
150	165.0	±1.0	±0.3	9.6	±0.6	4000	5000	6.701	6.561

(Unit: mm)

Notes: 1. Maximum/minimum outer dimensional tolerance is the difference between measured maximum and minimum values (maximum/minimum outer diameter) of any sectional outer diameter and the basic dimension. 2. Average outer dimensional tolerance is the difference between the average (average outer diameter) of measured values of outer diameters in 2 directions with an equal distance and the basic dimension. 3. The mass per 1m shown as reference is calculated using the pipe dimension as the basic dimension and setting the density of material for the pipe as 1.43g/cm³ for unplasticized polyvinyl chloride pipe and 1.40g/cm³ for impact-resistant unplasticized polyvinyl chloride pipe. It is not part of the standard. 4. Length tolerance shall be ⁺³⁰/₋₁₀ mm. 5. ● conform to the JPPFA standard (JPPFA AS20).

Tap Water Rubber Ring Socket Single-Side Straight Pipe (RR Pipe)

Abbreviation: **VPW** **HIVPW** Tap Water Rubber Ring Impact-Resistant Unplasticized Polyvinyl Chloride Pipe (JWWA K 129)



VPW
U-PVC



HIVPW
HI-PVC

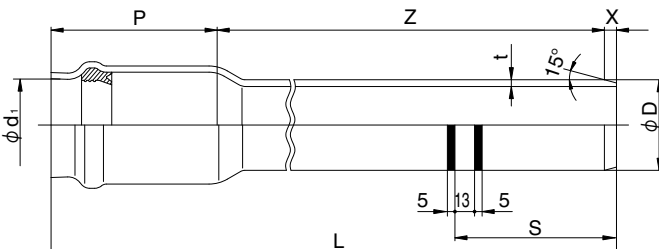

Maximum Working Pressure
(Hydrostatic pressure)

VPW
HIVPW 0.75MPa

Dimensions Table

Size	Port and Straight Part						Socket Part						Effective Length	Overall Length	Reference Weight (kg/piece)	
	Outer Diameter D			Thickness t	Chamfer Width X	Gauge Line S	Inner Diameter d ₁			Socket Depth P		Z			L	VP
	Basic Dimension	Max/Min. Tolerance	Average Tolerance	(Min.)			Basic Dimension	Max/Min. Tolerance	Average Tolerance	Basic Dimension	Tolerance		Tolerance			
50	60.0	±0.4	±0.2	4.1	8	107	60.9	±0.9	±0.6	110	±5	5000	5118	⁺³⁰ / ₋₁₀	5.8	5.7
75	89.0	±0.5	±0.2	5.5	11	120	90.2	±1.2	±0.7	120	±5	5000	5131	⁺³⁰ / ₋₁₀	11.5	11.3
100	114.0	±0.6	±0.2	6.6	13	132	115.3	±1.2	±0.7	130	±5	5000	5143	⁺³⁰ / ₋₁₀	17.9	17.5
● 125	140.0	±0.8	±0.3	7.0	14	138	141.4	±1.4	±0.8	135	±5	5000	5149	⁺³⁰ / ₋₁₀	23.5	23.0
150	165.0	±1.0	±0.3	9.0	18	152	166.6	±1.4	±0.8	145	±5	5000	5163	⁺³⁰ / ₋₁₀	35.2	34.5

(Unit: mm)

Notes: 1. ● conform to the JPPFA standard (JPPFA AS33 standard).
 2. Maximum/minimum outer dimensional tolerance is the difference between measured maximum or minimum outer diameter of any section and the basic dimension.
 3. Average outer dimensional tolerance is the difference between the circumference of any section divided by the circumference ratio (3.142) or the arithmetic mean value of measured outer diameters in 2 directions with an equal distance to each other and the basic dimension.

Rubber Ring Socket Single-Side Straight Pipe (RR Pipe)

Abbreviation: **VH** Agricultural Water Service Wall-Thickness Unplasticized Polyvinyl Chloride Pipe (JPPFA AS60)

PRODUCT MODEL CODE

VH ▶ P N U H7 J N Size Length



VH
U-PVC

Maximum Working Pressure
(Normal Temperature)

VH 1.25MPa

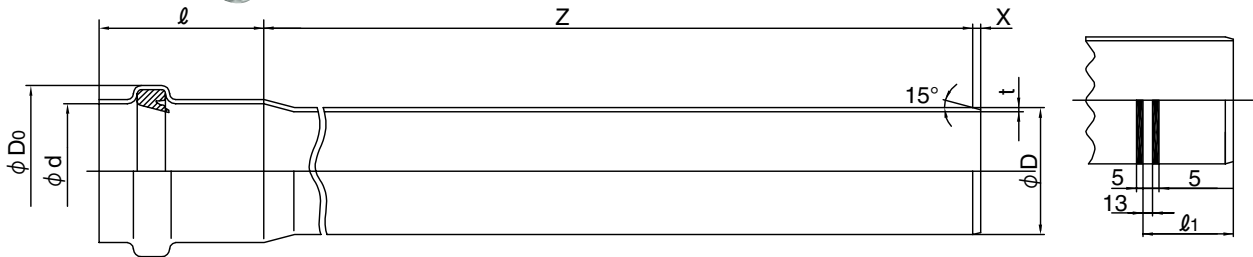

Dimensions Table

(Unit: mm)

Size	D			t	X	d (Min.)	ℓ	D ₀	ℓ ₁	Z	Overall Length	Reference Weight (kg/piece)
	Basic Dimension	Max/Min. Outer Dimensional Tolerance	Average Outer Dimensional Tolerance									
50	60.0	±0.4	±0.2	4.6 ^{+0.8} ₋₀	8	60.3	110±5	85	107	5000±15	5118	6.5
75	89.0	±0.5	±0.3	6.2 ^{+0.8} ₋₀	11	89.5	120±5	122	120	5000±15	5131	13.0
100	114.0	±0.6	±0.4	7.6 ^{+1.0} ₋₀	13	114.6	130±5	152	132	5000±15	5143	20.5
150	165.0	±1.0	±0.5	10.5 ^{+1.4} ₋₀	18	165.8	145±5	210	152	5000±15	5163	41.0
200	216.0	±1.3	±0.7	12.1 ^{+1.9} ₋₀	21	217.0	170±10	268	175	5000±15	5191	63.1
250	267.0	±1.6	±0.9	15.0 ^{+2.3} ₋₀	25	268.1	185±10	328	194	5000±15	5210	96.8
300	318.0	±1.9	±1.0	17.8 ^{+2.7} ₋₀	30	319.4	200±10	391	214	5000±15	5230	135.0

Notes: Dimensions without tolerance are reference value.

Perforated Pipe

Abbreviation: **VP** **VU** Perforated Unplasticized Polyvinyl Chloride Pipe (JPPFA AS13)

PRODUCT MODEL CODE

VP ▶ P N U P6 J U Size 04

VU ▶ P N U U6 J U Size 04

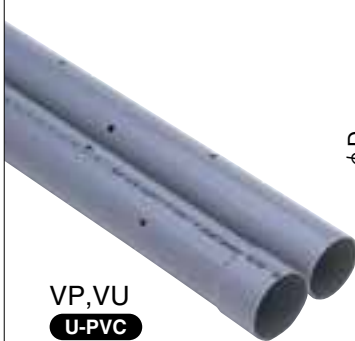

VP, VU
U-PVC

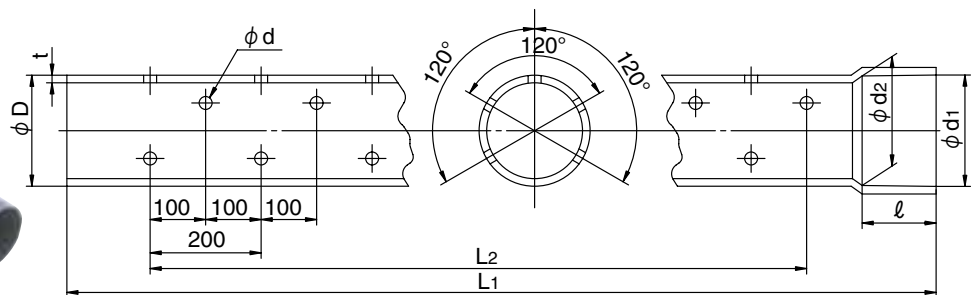

Dimensions Table

(Unit: mm)

Size	d ₁ (Min.)	d ₂ (Min.)	ℓ (Min.)	D	t		d	Number of Holes	L ₁	L ₂
					VP	VU				
50	60.2	59.2	40	60±0.2	4.1+0.8	1.8±0.4	7	95	3,950	3,700
65	76.3	75.1	40	76±0.3	4.1+0.8	2.2±0.6	7	95	3,950	3,700
75	89.3	88.0	40	89±0.3	5.5+0.8	2.7±0.6	12	95	3,950	3,700
100	114.4	112.8	50	114±0.4	6.6+1.0	3.1±0.8	12	95	3,950	3,700
125	140.5	138.7	60	140±0.5	7.0+1.0	4.1±0.8	12	95	3,950	3,700
150	165.5	163.4	75	165±0.5	8.9+1.4	5.1±0.8	20	95	3,950	3,700
200	216.7	214.0	100	216±0.7	10.3+1.4	6.5±1.0	20	95	3,950	3,700
250	267.9	264.8	125	267±0.9	12.7+1.8	7.8±1.2	20	90	3,950	3,500

PRODUCT MODEL CODE LIST

Type	Field	Material	Model	Standard	Type	Size
T	N	*	**	J	N	***
⋮	⋮	⋮	⋮	⋮	⋮	⋮
T TS Fitting	N Standard	U U-PVC I HI-PVC	9L 90° Elbow 4L 45° Elbow SO Socket TE Tee FL Faucet Elbow (Metal not contained) KL Faucet Elbow (Metal contained) FT Faucet Tee (Metal not contained) KT Faucet Tee (Metal not contained) FS Faucet Socket (Metal not contained) KS Faucet Socket (Metal contained) VS Valve Socket (Metal not contained) US Union Socket CP Cap	J JIS	N Standard	010 10mm 150 150mm 016013 16×13mm 150125 150×125mm

TS·HITS Fitting Common Dimensions

JISK6743

TS··Unplasticized Polyvinyl Chloride Pipe Fitting

HITS··Impact-Resistant Unplasticized Polyvinyl Chloride Pipe Fitting

Socket Common Dimensions
Size 13 – 50 mm

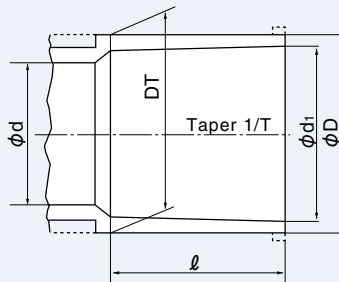

Socket Common Dimensions
Size 65 – 150 mm

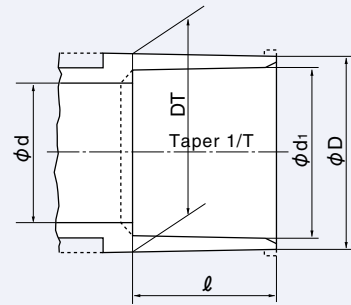

Dimensions Table

(Unit: mm)

Size	d ₁	d ₁ Tolerance	ℓ	1/T	D	DT	D and DT Tolerance	d (Min.)	Applicable Pipe Outer Diameter
□ 10	15.40	±0.20	22.0	1/25	21.0	21.0	-0.5	10	15
13	18.40	±0.20	26.0	1/30	24.0	24.0	-0.6	13	18
16	22.40	±0.20	30.0	1/34	29.0	29.0	-0.7	16	22
20	26.45	±0.20	35.0	1/34	33.0	33.0	-0.8	20	26
25	32.55	±0.25	40.0	1/34	40.0	40.0	-1.0	25	32
30	38.60	±0.25	44.0	1/34	46.0	46.0	-1.0	31	38
40	48.70	±0.30	55.0	1/37	57.0	57.0	-1.2	40	48
50	60.80	±0.30	63.0	1/37	70.0	70.0	-1.5	51	60
● 65	76.60	±0.30	61.0	1/48	87.0	88.5	-1.5	67	76
75	89.60	±0.30	64.0	1/49	102.0	104.5	-1.5	77	89
100	114.70	±0.30	84.0	1/56	130.0	133.5	-1.8	100	114
● 125	140.85	±0.35	104.0	1/58	157.0	161.0	-1.8	125	140
150	166.00	±0.40	132.0	1/63	186.0	190.0	-2.0	146	165

- Notes: 1. ℓ tolerance shall be ⁺⁴_{-0.5} mm.
 2. D and DT tolerance and t tolerance on the plus side are not restricted.
 3. □ conform to the AV standard.
 4. ● conform to the JPPFA standard.

Elbow

Abbreviation: **L**

Unplasticized Polyvinyl Chloride Pipe Fitting (JIS K6743)

PRODUCT MODEL CODE	TS	T	N	U	9L	J	N	Size
	HITS	T	N	I	9L	J	N	Size



Size 13 – 50 mm

Size 65 – 150 mm

Max. Working Pressure (Hydrostatic pressure)
TS • HITS 0.75MPa

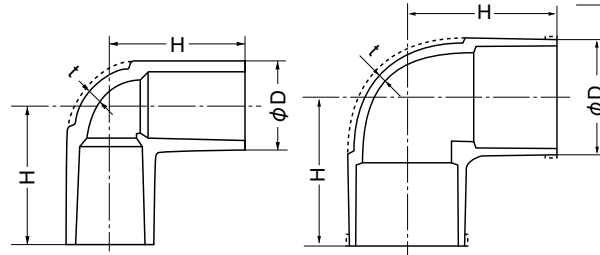

Dimensions Table

(Unit: mm)

Size	TS	HITS	D	t	H
13	○	○	24.0	3.0	36
16	○	○	29.0	3.5	43
20	○	○	33.0	3.5	50
25	○	○	40.0	4.0	58
30	○	○	46.0	4.0	65
40	○	○	57.0	4.5	82

Size	TS	HITS	D	t	H
50	○	○	70.0	5.0	96
65	●	●	87.0	6.6	110
75	●	●	102.0	8.0	120
100	●	●	130.0	10.0	153
125	●	●	157.0	11.0	188
150	●	●	186.0	13.0	230

Notes: 1. H tolerance shall be $^{+5}_{-1}$ mm. 2. ● conform to the JPPFA standard. 3. ○ are accordance with JIS K6743.

45° Elbow

Abbreviation: **45L**

Unplasticized Polyvinyl Chloride Pipe Fitting (JIS K6743)

PRODUCT MODEL CODE	TS	T	N	U	4L	J	N	Size
	HITS	T	N	I	4L	J	N	Size

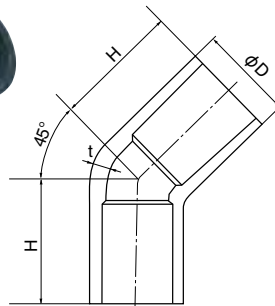

Max. Working Pressure (Hydrostatic pressure)
TS • HITS 0.75MPa

Dimensions Table

(Unit: mm)

Size	TS	HITS	D	t	H
20	○	○	33.0	3.5	44
25	○	○	40.0	4.0	51

Notes: 1. H tolerance shall be $^{+5}$ mm.
2. ○ are accordance with JIS K6743.

Socket

Abbreviation: **S**

Unplasticized Polyvinyl Chloride Pipe Fitting (JIS K6743)

PRODUCT MODEL CODE	TS	T	N	U	SO	J	N	Size
	HITS	T	N	I	SO	J	N	Size

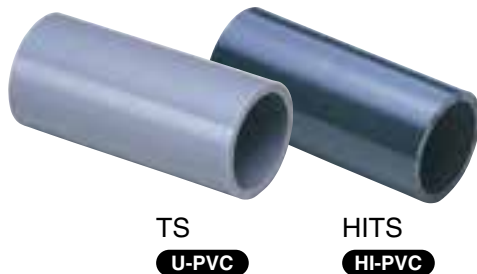

Size 13 – 50 mm

Size 65 – 150 mm

Max. Working Pressure (Hydrostatic pressure)
TS • HITS 0.75MPa

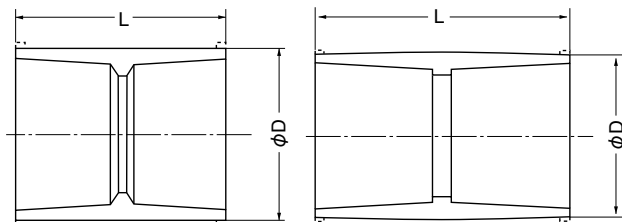

Dimensions Table

(Unit: mm)

Size	TS	HITS	D	L
13	○	○	24.0	57
16	○	○	29.0	67
20	○	○	33.0	77
25	○	○	40.0	87
30	○	○	46.0	95
40	○	○	57.0	117

Size	TS	HITS	D	L
50	○	○	70.0	133
65	●	●	87.0	145
75	○	○	102.0	155
100	○	○	130.0	200
125	●	●	157.0	240
150	○	○	186.0	300

Notes: 1. L tolerance shall be ± 4.0 mm. 2. ● conform to the JPPFA standard. 3. ○ are accordance with JIS K6743.

Reducing Socket

Abbreviation: **RS**

Unplasticized Polyvinyl Chloride Pipe Fitting (JIS K6743)

PRODUCT
MODEL CODE

TS ▶ T N U SO J N Size

HITS ▶ T N I SO J N Size



TS **U-PVC**



HITS **HI-PVC**

Maximum Working Pressure
(Hydrostatic pressure)

TS • HITS 0.75MPa

Size 13 – 50 mm

Size 65 – 150 mm

Detail of part A

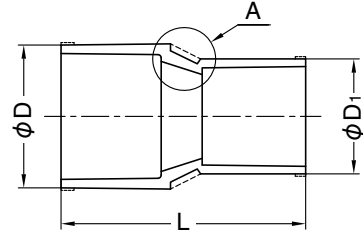
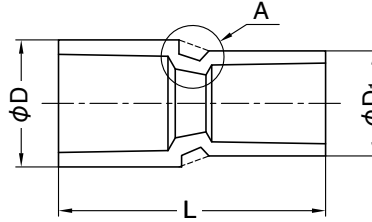
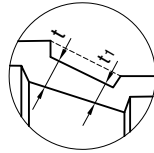

Dimensions Table

(Unit: mm)

Size	TS	HITS	D	t	D ₁	t ₁	L
16×13	○	○	29.0	3.5	24.0	3.0	61
20×13	○	○	33.0	3.5	24.0	3.0	68
20×16	○	○	33.0	3.5	29.0	3.5	71
25×13	○	○	40.0	4.0	24.0	3.0	86
25×16	○	○	40.0	4.0	29.0	3.5	85
25×20	○	○	40.0	4.0	33.0	3.5	84
30×20	○	○	46.0	4.0	33.0	3.5	93
30×25	○	○	46.0	4.0	40.0	4.0	93
40×20	●	●	57.0	4.5	33.0	3.5	113
40×25	○	○	57.0	4.5	40.0	4.0	114
40×30	○	○	57.0	4.5	46.0	4.0	114

Size	TS	HITS	D	t	D ₁	t ₁	L
50×20	●	●	70.0	5.0	33.0	3.5	116
50×25	●	●	70.0	5.0	40.0	4.0	140
50×30	○	○	70.0	5.0	46.0	4.0	136
50×40	○	○	70.0	5.0	57.0	4.5	136
▲ 65×40	□	□	87.0	6.6	57.0	4.5	145
65×50	●	●	87.0	6.6	70.0	5.0	149
▲ 75×40	□	□	102.0	8.0	57.0	4.5	153
75×50	○	○	102.0	8.0	70.0	5.0	165
75×65	●	●	102.0	8.0	87.0	6.6	159
100×75	○	○	130.0	10.0	102.0	8.0	190
125×100	●	●	157.0	11.0	130.0	10.0	229
▲ 150×100	○	○	186.0	13.0	130.0	10.0	295
150×125	○	○	186.0	13.0	157.0	11.0	272

Notes: 1. L tolerance shall be ± 4.0 mm. 2. ● conform to the JPPFA standard. 3. □ conform to the AV standard.
4. ▲ are stock products. 5. ○ are accordance with JIS K6743.

Tee

Abbreviation: **T**

Unplasticized Polyvinyl Chloride Pipe Fitting (JIS K6743)

PRODUCT
MODEL CODE

TS ▶ T N U TE J N Size

HITS ▶ T N I TE J N Size



TS **U-PVC**



HITS **HI-PVC**

Maximum Working Pressure
(Hydrostatic pressure)

TS • HITS 0.75MPa

Size 13 – 50 mm

Size 65 – 150 mm

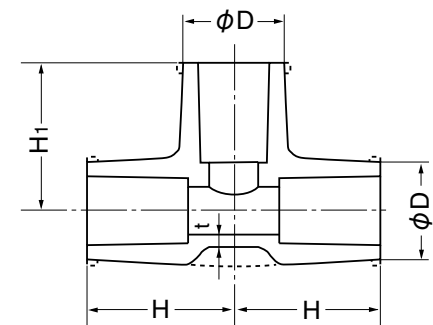
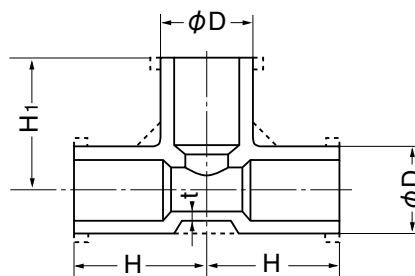

Dimensions Table

(Unit: mm)

Size	TS	HITS	D	t	H	H ₁
13	○	○	24.0	3.0	36	36
16	○	○	29.0	3.5	43	43
20	○	○	33.0	3.5	50	50
25	○	○	40.0	4.0	58	58
30	○	○	46.0	4.0	65	65
40	○	○	57.0	4.5	82	82

Size	TS	HITS	D	t	H	H ₁
50	○	○	70.0	5.0	96	96
65	●	●	87.0	6.6	110	110
75	○	○	102.0	8.0	120	120
100	○	○	130.0	10.0	152	152
125	●	●	157.0	11.0	187	187
150	○	○	186.0	13.0	230	230

Notes: 1. H tolerance shall be ± 0.5 mm. 2. ● conform to the JPPFA standard. 3. ○ are accordance with JIS K6743.

Reducing Tee

Abbreviation: **T**

Unplasticized Polyvinyl Chloride Pipe Fitting (JIS K6743)

PRODUCT MODEL CODE	TS	T	N	U	TE	J	N	Size
	HITS	T	N	I	TE	J	N	Size

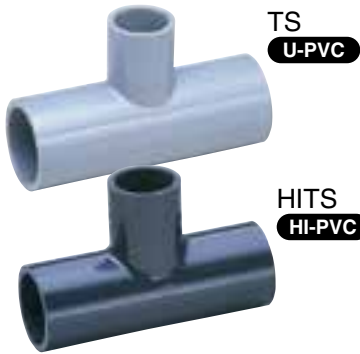

Size 13 – 50 mm

Size 65 – 150 mm

Maximum Working Pressure (Hydrostatic pressure)
TS • HITS 0.75MPa

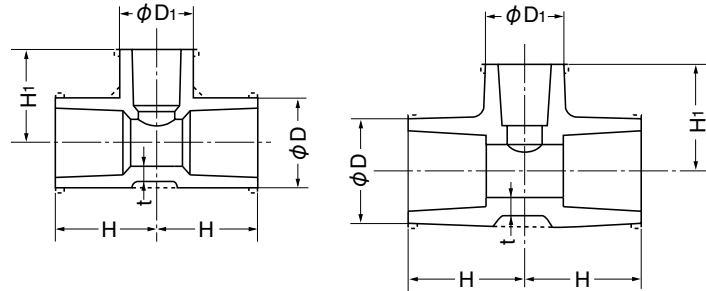

Dimensions Table

(Unit: mm)

Size	TS	HITS	D	t	H	D ₁	H ₁
16×13	○	○	29.0	3.5	41	24.0	38
20×13	○	○	33.0	3.5	46	24.0	40
20×16	○	○	33.0	3.5	48	29.0	45
25×13	○	○	40.0	4.0	51	24.0	43
25×16	○	○	40.0	4.0	53	29.0	48
25×20	○	○	40.0	4.0	55	33.0	53
▲ 30×13	○	○	46.0	4.0	55	24.0	46
30×16	○	○	46.0	4.0	57	29.0	51
30×20	○	○	46.0	4.0	59	33.0	56
30×25	○	○	46.0	4.0	62	40.0	61

Size	TS	HITS	D	t	H	D ₁	H ₁
40×13	○	○	57.0	4.5	66	24.0	52
▲ 40×16	○	○	57.0	4.5	68	29.0	57
40×20	○	○	57.0	4.5	70	33.0	62
40×25	○	○	57.0	4.5	73	40.0	67
40×30	○	○	57.0	4.5	76	46.0	71
50×13	○	○	70.0	5.0	74	24.0	58
50×16	○	○	70.0	5.0	76	29.0	63
50×20	○	○	70.0	5.0	78	33.0	68
50×25	○	○	70.0	5.0	81	40.0	73
50×30	○	○	70.0	5.0	84	46.0	77
50×40	○	○	70.0	5.0	90	57.0	88

Size	TS	HITS	D	t	H	D ₁	H ₁
65× 40	●	●	87.0	6.6	100	57.0	95
65× 50	●	●	87.0	6.6	101	70.0	104
75× 25	○	○	102.0	8.0	93	40.0	88
75× 40	○	○	102.0	8.0	100	57.0	102
75× 50	○	○	102.0	8.0	105	70.0	110
▲ 75× 65	●	●	102.0	8.0	113	87.0	117

Size	TS	HITS	D	t	H	D ₁	H ₁
100× 50	○	○	130.0	10.0	125	70.0	122
100× 75	○	○	130.0	10.0	140	102.0	132
125× 75	●	●	157.0	11.0	160	102.0	147
125×100	●	●	157.0	11.0	173	130.0	167
150× 75	○	○	186.0	13.0	195	102.0	158
150×100	○	○	186.0	13.0	208	130.0	182
150×125	●	●	186.0	13.0	217	157.0	201

Notes: 1. H and H₁ tolerance shall be ± 0.5 mm. 2. ● conform to the JPPFA standard.
3. ▲ are stock products. (PVC (30×13) are our products.) 4. ○ are accordance with JIS K6743.

Faucet Elbow

Abbreviation: **FL**

Unplasticized Polyvinyl Chloride Pipe Fitting (JIS K6743)

PRODUCT MODEL CODE	TS	T	N	U	FL	J	N	Size
	HITS	T	N	I	FL	J	N	Size

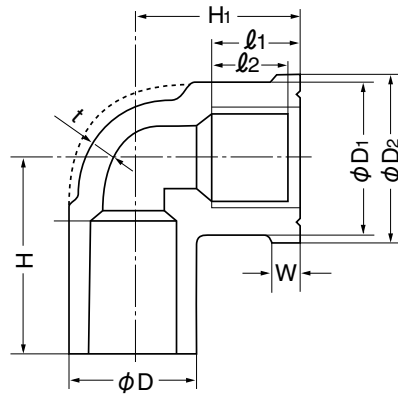

Maximum Working Pressure (Hydrostatic pressure)
TS • HITS 0.75MPa

<Use Precautions>

- * Use both seal tape and gasket for connection of threaded ends.
- * Do not use them for connecting steel pipe and PVC pipe.
- * Fix the area around an elbow using a retainer.

Dimensions Table

(Unit: mm)

Size	TS	HITS	D	t	D ₁	D ₂	l ₁	l ₂	W	H	H ₁	Female Thread Size
13	□	□	24.0	3.0	30	34	17	14	4	38	29	Rp1/2
16	□	□	29.0	3.5	30	34	17	14	4	43	32	Rp1/2
20	□	□	33.0	3.5	37	42	19	16	4	51	36	Rp3/4
25	□	□	40.0	4.0	46	52	21	18	5	59	40	Rp1

Notes: 1. Threaded end shall be parallel female thread of JIS B 0203 (taper threaded end for pipes). 2. H tolerance shall be ± 0.5 mm.
3. H₁ tolerance shall be ± 0.5 mm. 4. □ conform to the AV standard. 5. l₂ tolerance shall be ± 1 mm.

Metal-Containing Faucet Elbow

Abbreviation: **KFL**

Unplasticized Polyvinyl Chloride Pipe Fitting (JIS K6743)

PRODUCT
MODEL CODE

TS ▶ T N U KL J N Size

HITS ▶ T N I KL J N Size

Maximum Working Pressure
(Hydrostatic pressure)

TS • HITS 0.75MPa



TS U-PVC

HITS HI-PVC

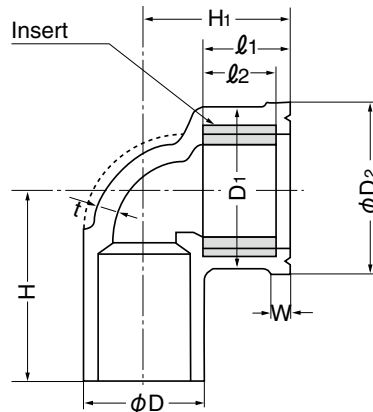

<Use Precautions>

- * Use both seal tape and gasket for connection of threaded ends.
- * Do not use them for connecting faucet with a taper threaded end and steel pipe.
- * Fix the area around an elbow using a retainer.

Dimensions Table

(Unit: mm)

Size	TS	HITS	D	t	D ₁	D ₂	l ₁	l ₂	W	H	H ₁	Female Thread Size
13	○	○	24.0	3.0	30	34	17	14	4	38	29	Rp1/2
16×13	○	○	29.0	3.0	30	34	17	14	4	43	32	Rp1/2
20	○	○	33.0	3.5	37	42	19	16	4	51	36	Rp3/4
25	○	○	40.0	4.0	46	52	21	18	5	59	40	Rp1
20×13	○	○	33.0	3.5	30	34	17	14	4	47	33	Rp1/2

Notes: 1. Insert shall be free-cutting brass of JIS H3250 (copper and copper alloy rod). 2. Threaded end shall be parallel female thread of JIS B0203 (taper threaded end for pipes). 3. H tolerance shall be ± 0.1 mm. 4. H₁ tolerance shall be ± 0.1 mm. 5. l₂ tolerance shall be ± 1 mm. 6. ○ are accordance with JIS K6743.

Faucet Tee

Abbreviation: **FT**

Unplasticized Polyvinyl Chloride Pipe Fitting (JIS K6743)

PRODUCT
MODEL CODE

TS ▶ T N U FT J N Size

HITS ▶ T N I FT J N Size

Maximum Working Pressure
(Hydrostatic pressure)

TS • HITS 0.75MPa



TS U-PVC

HITS HI-PVC

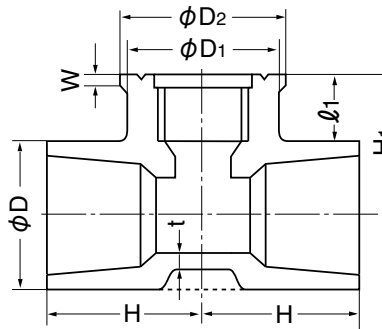

<Use Precautions>

- * Use both seal tape and gasket for connection of threaded ends.
- * Do not use them for connecting steel pipe and PVC pipe.
- * Fix the area around a tee using a retainer.

Dimensions Table

(Unit: mm)

Size	TS	HITS	D	t	D ₁	D ₂	l ₁	W	H	H ₁	Female Thread Size
▲ 13	□	□	24.0	3.0	28	34	17	4	38	29	Rp1/2
20	□	□	33.0	3.5	37	42	19	4	51	36	Rp3/4
25	□	□	40.0	4.0	46	52	21	5	59	42	Rp1
▲16×13	□	□	29.0	3.5	28	34	17	4	43	32	Rp1/2
20×13	□	□	33.0	3.5	30	34	17	4	47	34	Rp1/2
25×13	□	□	40.0	4.0	30	34	17	4	52	38	Rp1/2
25×20	□	□	40.0	4.0	37	42	19	4	56	40	Rp3/4

Notes: 1. Threaded end shall be parallel female thread of JIS B 0203 (taper threaded end for pipes). 2. H tolerance shall be ± 0.1 mm. 3. H₁ tolerance shall be ± 0.1 mm. 4. □ conform to the AV standard. 5. ▲ are stock products.

Metal-Containing Faucet Tee

Abbreviation: **KFT**

Unplasticized Polyvinyl Chloride Pipe Fitting (JIS K6743)

PRODUCT
MODEL CODE

TS ▶ T N U KT J N Size

HITS ▶ T N I KT J N Size

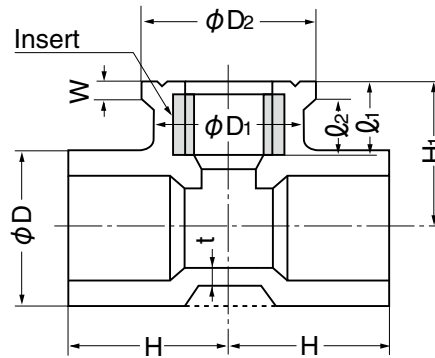

Maximum Working Pressure
(Hydrostatic pressure)

TS • HITS 0.75MPa

<Use Precautions>

- * Use both seal tape and gasket for connection of threaded ends.
- * Do not use them for connecting faucet with a taper threaded end and steel pipe.
- * Fix the area around a tee using a retainer.

■ Dimensions Table

(Unit: mm)

Size	TS	HITS	D	t	D ₁	D ₂	l ₁	l ₂	W	H	H ₁	Female Thread Size
20	○	○	33.0	3.5	37	42	19	16	4	51	36	Rp3/4
25	○	○	40.0	4.0	46	52	21	18	5	59	42	Rp1
20×13	○	○	33.0	3.5	30	34	17	14	4	47	34	Rp1/2
25×13	○	○	40.0	4.0	30	34	17	14	4	52	38	Rp1/2
25×20	○	○	40.0	4.0	37	42	19	16	4	56	40	Rp3/4

Notes: 1. Insert shall be free-cutting brass of JIS H3250 (copper and copper alloy rod). 2. Threaded end shall be parallel female thread of JIS B0203 (taper threaded end for pipes). 3. l₂ tolerance shall be ±1 mm. 4. H tolerance shall be ⁺⁵ mm. 5. H₁ tolerance shall be ⁺⁵ mm. 6. ○ are accordance with JIS K6743.

Faucet Socket

Abbreviation: **FS**

PRODUCT
MODEL CODE

TS ▶ T N U FS J N Size

HITS ▶ T N I FS J N Size

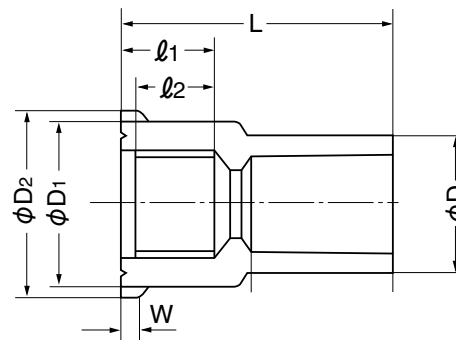

Maximum Working Pressure
(Hydrostatic pressure)

TS • HITS 0.75MPa

<Use Precautions>

- * Use both seal tape and gasket for connection of threaded ends.
- * Do not use them for connecting steel pipe and PVC pipe.

■ Dimensions Table

(Unit: mm)

Size	TS	HITS	D	D ₁	D ₂	l ₁	l ₂	W	L	Female Thread Size
13	□	□	24.0	30	34	17	14	4	47	Rp1/2
16	□	□	29.0	30	34	17	14	4	52	Rp1/2
20	□	□	33.0	37	42	19	16	4	59	Rp3/4
25	□	□	40.0	46	52	21	18	5	68	Rp1

Notes: 1. Threaded end shall be parallel female thread of JIS B 0203 (taper threaded end for pipes). 2. L tolerance shall be ⁺⁵ mm. 3. l₂ tolerance shall be ±1 mm. 4. □ conform to the AV standard.

Metal-Containing Faucet Socket

Abbreviation: **KFS**

Unplasticized Polyvinyl Chloride Pipe Fitting (JIS K6743)

PRODUCT
MODEL CODE

TS ▶ T N U KS J N Size

HITS ▶ T N I KS J N Size

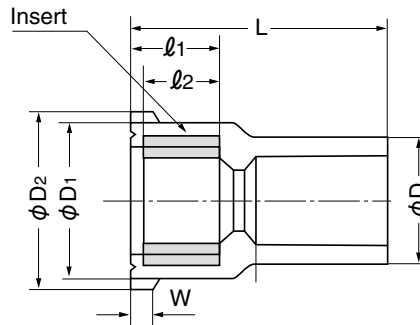
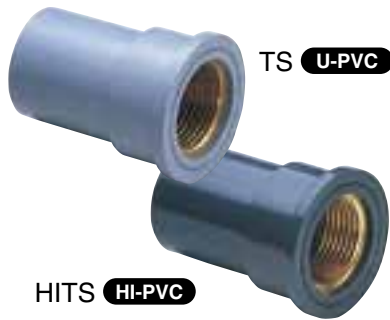

Maximum Working Pressure
(Hydrostatic pressure)

TS · HITS 0.75MPa

<Use Precautions>

- * Use both seal tape and gasket for connection of threaded ends.
- * Do not use them for connecting faucet with a taper threaded end and steel pipe.

Dimensions Table

(Unit: mm)

Size	TS	HITS	D	D1	D2	l ₁	l ₂	W	L	Female Thread Size
13	○	○	24.0	30	34	17	14	4	47	Rp1/2
16×13	○	○	29.0	30	34	17	14	4	52	Rp1/2
20	○	○	33.0	37	42	19	16	4	59	Rp3/4
25	○	○	40.0	46	52	21	18	5	68	Rp1
20×13	○	○	33.0	30	34	17	14	4	57	Rp1/2

Notes: 1. Insert shall be free-cutting brass of JIS H3250 (copper and copper alloy rod). 2. Threaded end shall be parallel female thread of JIS B0203 (taper threaded end for pipes). 3. L tolerance shall be $^{+5}$ mm. 4. l₂ tolerance shall be ± 1 mm. 5. ○ are accordance with JIS K6743.

Valve Socket

Abbreviation: **VS**

Unplasticized Polyvinyl Chloride Pipe Fitting (JIS K6743)

PRODUCT
MODEL CODE

TS ▶ T N U VS J N Size

HITS ▶ T N I VS J N Size

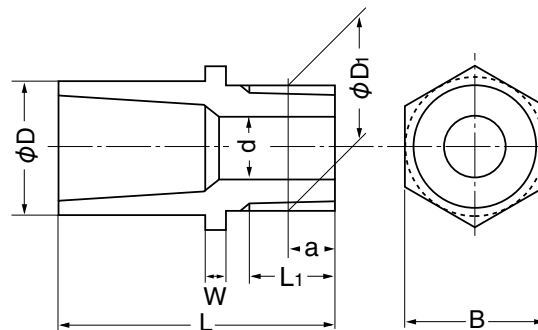

Maximum Working Pressure
(Hydrostatic pressure)

TS · HITS 0.75MPa

<Use Precautions>

- * Avoid screwing in and removing repeatedly.
- * Connect threaded parts using seal tape.
- * Do not use them for connecting with steel pipe.
- * Do not use them for buried pipe.
- * Do not use them for the area where an external force such as bending and vibration is applied.

Dimensions Table

(Unit: mm)

Size	TS	HITS	D	d	Thread Nominal	Basic Diameter Outer Diameter D1	Thread Number of Threads/Inch	Basic Diameter Position a	L ₁ (Min.)	W	L	B
10	□	—	21.0	10	R3/8	16.662	19	6.35	12	6	43	21
13	○	○	24.0	13	R1/2	20.955	14	8.16	13.16	6	50	24
16	○	○	29.0	13	R1/2	20.955	14	8.16	13.16	6	54	29
20	○	○	33.0	18	R3/4	26.441	14	9.53	14.53	8	64	33
25	○	○	40.0	23	R1	33.249	11	10.39	16.79	8	71	40
30	○	○	46.0	31	R1 1/4	41.910	11	12.70	19.10	10	80	46
40	○	○	57.0	37	R1 1/2	47.803	11	12.70	19.10	10	92	57
50	○	○	70.0	48	R2	59.614	11	15.88	23.38	12	106	70
65	□	□	87.0	62	R2 1/2	75.184	11	17.46	30	15	118	87
75	□	□	102.0	72	R3	87.884	11	20.64	34	16	127	102
100	□	□	130.0	96	R4	113.030	11	25.40	40	18	157	130
125	□	—	157.0	119	R5	138.430	11	28.58	44	20	186	157
▲150	□	—	185.0	142	R6	163.830	11	28.58	44	25	220	185

Notes: 1. Threaded end shall conform to taper male threaded end of JIS B0203 (taper threaded end for pipes). 2. L tolerance shall be $^{+5}$ mm. 3. □ conform to the JPPFA standard. 4. □ conform to the AV standard. 5. B tolerance shall conform to D tolerance. 6. Products with the threaded part containing metal are also available for the size 13 mm. 7. ▲ are stock products. 8. ○ are accordance with JIS K6743.

Union Socket

Abbreviation: **US**

Unplasticized Polyvinyl Chloride Pipe Fitting (JIS K6743)

PRODUCT MODEL CODE	TS	T	N	U	US	J	N	Size
	HITS	T	N	I	US	J	N	Size

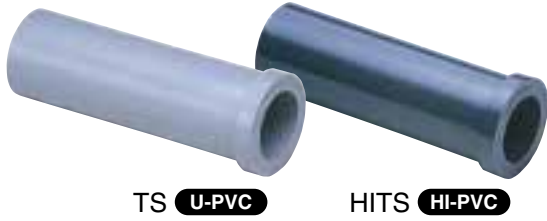

TS **U-PVC**

HITS **HI-PVC**

Maximum Working Pressure (Hydrostatic pressure)
TS • HITS 0.75MPa

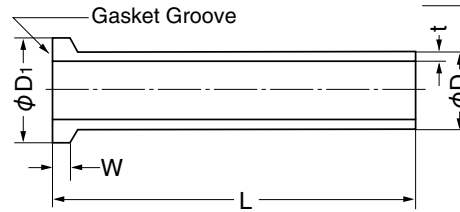

Dimensions Table

Size	TS	HITS	D	t	D1	W	L
13	○	○	18.0	2.5	23.0	5	80
▲16	○	○	22.0	3.0	27.5	5	85
20	○	○	26.0	3.0	29.5	6	90
25	○	○	32.0	3.5	36.5	7	100

Size	TS	HITS	D	t	D1	W	L
▲30	○	○	38.0	3.5	42.0	8	110
▲40	○	○	48.0	4.0	53.0	8	120
▲50	○	○	60.0	4.5	71.0	9	130

(Unit: mm)

Notes: 1. L tolerance shall be $^{+5}$ mm. 2. ▲ are stock products. 3. ○ are accordance with JIS K6743.

Cap

Abbreviation: **C**

Unplasticized Polyvinyl Chloride Pipe Fitting (JIS K6743)

PRODUCT MODEL CODE	TS	T	N	U	CP	J	N	Size
	HITS	T	N	I	CP	J	N	Size

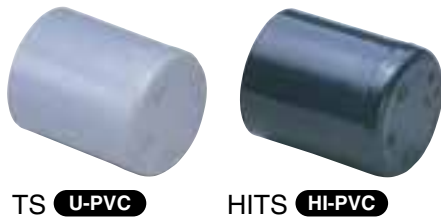

TS **U-PVC**

HITS **HI-PVC**

Maximum Working Pressure (Hydrostatic pressure)
TS • HITS 0.75MPa

Size 13 – 50 mm

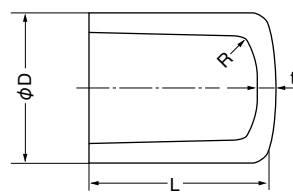

Size 65 – 150 mm

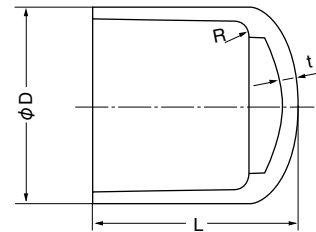

Dimensions Table

Size	TS	HITS	D	t	L
13	○	○	24.0	3.0	29.0
16	○	○	29.0	3.5	33.5
20	○	○	33.0	3.5	38.5
25	○	○	40.0	4.0	44.0
30	○	○	46.0	4.0	48.0
40	○	○	57.0	4.5	59.5

Size	TS	HITS	D	t	L
50	○	○	70.0	5.0	68.0
65	●	●	87.0	6.6	96.0
75	○	○	102.0	8.0	105.0
100	●	●	130.0	10.0	138.0
150	○	○	186.0	13.0	205.0

(Unit: mm)

Notes: 1. L tolerance shall be $^{+5}$ mm. 2. ● conform to the AV standard and the JPPFA standard. 3. R tolerance shall be 1 to 5 mm. 4. ○ are accordance with JIS K6743.

PRODUCT MODEL CODE LIST

Type	Field	Material	Model	Standard	Type	Size
R	N	*	MF	*	*	***
⋮	⋮	⋮	⋮	⋮	⋮	⋮
R RR Fitting	N None Color	U U-PVC I HI-PVC R FRP	MF RR-MF Joint	J JIS W Waterworks	I Casted Product S Bonded Product	040 40 mm I 300 300 mm

RR-MF Joint (Casted Product)

PRODUCT MODEL CODE	U-PVC Waterworks	R	N	U	MF	W	I	Size
	HI-PVC Waterworks	R	N	I	MF	W	I	Size
	U-PVC 10K	R	N	U	MF	J	I	Size
	HI-PVC 10K	R	N	I	MF	J	I	Size

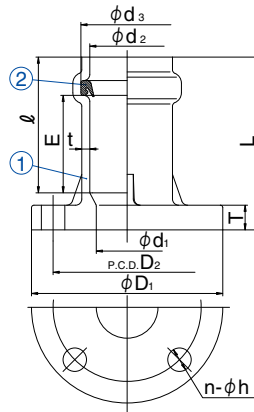
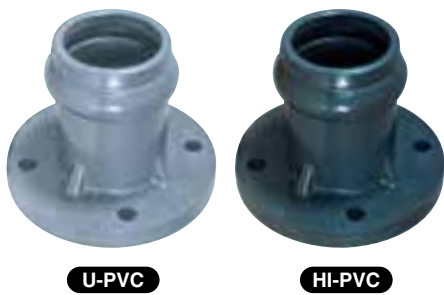

No.	Description	pcs.	Material
①	MF Joint	1	U-PVC, HI-PVC
②	Rubber Ring	1	SBR

Dimensions Table

(Unit: mm)

Size	d ₁	JIS B 2062 Waterworks				JIS 10K				T	d ₂	d ₃	E (Min.)	ℓ	t	L
		D ₁	D ₂	n	h	D ₁	D ₂	n	h							
40	40	140	105	4	19	140	105	4	19	16	48.5	58	54	100	5	120
50	50	155	120	4	19	155	120	4	19	20	60.5	75	56	110	6.5	140
80 (75)	78	211	168	4	19	185	150	8	19	22	90.2	109	61	120	9	160
100	100	238	195	4	19	210	175	8	19	24	115.3	136	64	130	10.5	175
125	125	263	220	6	19	250	210	8	23	24	140.6	164	68	140	12	190
150	148	290	247	6	19	280	240	8	23	24	166.6	191	70	145	14	200

Notes: D₁, D₂, n and h for 40 mm and 50 mm are accordance with the JIS 10K standard.

AV RR-MF Joint (Bonded Product)

PRODUCT MODEL CODE	U-PVC Waterworks	R	N	U	MF	W	S	Size
	U-PVC 10K	R	N	U	MF	J	S	Size

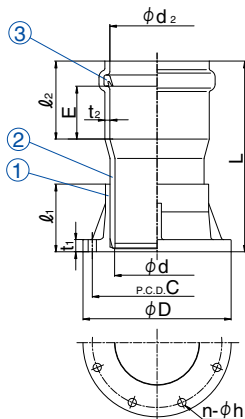

No.	Description	pcs.	Material
①	TS Flange	1	U-PVC
②	RR Short Pipe	1	U-PVC
③	Rubber Ring	1	SBR

Dimensions Table

(Unit: mm)

Size	d	JIS B 2062 Waterworks				JIS 10K				t ₁	ℓ ₁	d ₂	E (Min.)	ℓ ₂	t ₂	L
		D	C	n	h	D	C	n	h							
200	196	342	299	8	19	330	290	12	23	28	156	218.0±1.1	76	170±5	10.3±1.4	440
250	247	410	360	8	23	400	355	12	25	30	167	269.3±1.2	82	185±5	12.7±1.8	515
300	298	464	414	10	23	445	400	16	25	30	167	320.7±1.4	88	200±5	15.1±2.2	535

FRP RR-MF Joint <Used for both VU and VM with Retainer>

FRP
RR-MF
JOINT

R N R MF W I Size

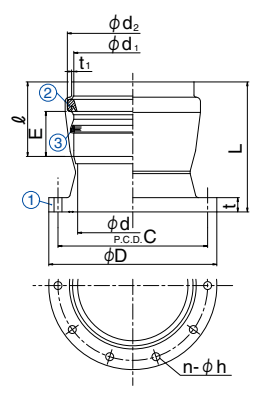

Maximum Working Pressure (Normal Temperature)	
VU	0.8MPa
VM	0.6MPa

No.	Description	pcs.	Material
①	MF Joint	1	FRP
②	Rubber Ring	1	SBR
③	Ring	1	SUS

■ Dimensions Table

(Unit: mm)

Size	d	JIS B 2062 Waterworks				t	d1 (Mn.)	d2	ℓ	E (Min.)	t1 (Min.)	L
		D	C	n	h							
350	348	530	472	10	25	45	371.5	413	235	132	6.9	410
400	395	582	524	12	25	47	421.7	470	255	153	7.9	460
450	442	652	585	12	27	49	471.9	525	280	166	8.9	512
500	489	706	639	12	27	51	522.1	586	300	175	10.0	570

PRODUCT MODEL CODE LIST

Type	Field	Material	Model	Standard	Others	Size
*	N	*	**	V	N	***
⋮	⋮	⋮	⋮	⋮	⋮	⋮
B Bend T TS Fitting	N Standard	U U-PVC I HI-PVC	90 90° Bend 45 45° Bend 9L 90° Elbow SO Socket TE Tee	V AV	N Normal Color	200 200 mm I 300 300 mm

AV90° Bend

PRODUCT MODEL CODE

TS ▶ B N U 90 V N Size

HITS ▶ B N I 90 V N Size



TS U-PVC

HITS HI-PVC

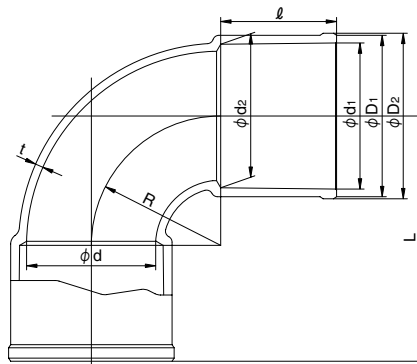

Maximum Working Pressure (Normal Temperature)

75 – 150 mm	1.0MPa
200mm	0.75MPa
U-PVC 250mm	0.6MPa
HI-PVC 250mm	0.75MPa
300mm	0.4MPa

Dimensions Table

(Unit: mm)

Size	TS	HITS	d ₁	d ₂	ℓ	D ₁ (Min.)	D ₂ (Reference)	d	t (Min.)	L	R
75	<input type="checkbox"/>	-	89.80	88.13	72	101	104	78	6	137	65
100	<input type="checkbox"/>	-	115.00	112.89	92	129	132	100	7.3	172	80
125	<input type="checkbox"/>	-	141.20	138.72	112	156	160	125	7.7	237	125
150	<input type="checkbox"/>	-	166.50	163.39	140	185	189	148	9.8	260	120
200	<input type="checkbox"/>	<input type="checkbox"/>	217.00	214.10	145	240	244	196	15	341	196
250	<input type="checkbox"/>	<input type="checkbox"/>	268.20	265.00	155	293	298	247	16	402	247
300	<input type="checkbox"/>	<input type="checkbox"/>	318.70	315.88	155	337	341	298	10	395	240

Notes: 1. conform to the AV standard.

AV45° Bend

PRODUCT MODEL CODE	TS	▶	B	N	U	45	V	N	Size
	HITS	▶	B	N	I	45	V	N	Size



TS **U-PVC**



HITS **HI-PVC**

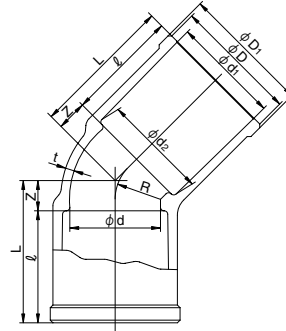

Dimensions Table

(Unit: mm)

Size	TS	HITS	d ₁	d ₂	ℓ	D (Min.)	D ₁ (Reference)	d	t (Min.)	Z	L	R
40	<input type="checkbox"/>	<input type="checkbox"/>	48.70	47.21	55	57	60	40	4.5	14	69	20
50	<input type="checkbox"/>	<input type="checkbox"/>	60.80	59.10	63	70	73	51	5	17	80	25.5
65	<input type="checkbox"/>	<input type="checkbox"/>	76.60	75.33	61	87	90	67	6.6	20	81	34
75	<input type="checkbox"/>	<input type="checkbox"/>	89.80	88.13	72	101	104	78	6	25	97	39
100	<input type="checkbox"/>	<input type="checkbox"/>	115.00	112.89	92	129	132	100	7.3	30	122	50
125	<input type="checkbox"/>	<input type="checkbox"/>	141.20	138.71	112	156	160	125	7.7	37	149	62.5
150	<input type="checkbox"/>	<input type="checkbox"/>	166.50	163.39	140	185	189	148	10	44	184	74
200	<input type="checkbox"/>	<input type="checkbox"/>	217.00	214.10	145	240	244	196	15	48	193	98
250	<input type="checkbox"/>	<input type="checkbox"/>	268.20	265.00	155	293	298	247	16	58	213	123.5
300	<input type="checkbox"/>	<input type="checkbox"/>	318.70	315.88	155	337	341	298	10	70	225	149

Notes: 1. conform to the AV standard.

Short Elbow

PRODUCT MODEL CODE	TS	▶	T	N	U	9L	V	N	Size
	HITS	▶	T	N	I	9L	V	N	Size



TS **U-PVC**



HITS **HI-PVC**

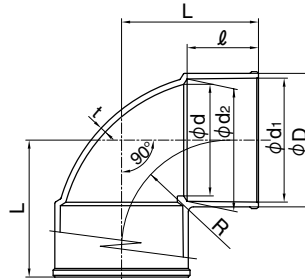

Dimensions Table

(Unit: mm)

Size	TS	HITS	d ₁	d ₂	ℓ	D	d	t	L	R
200	<input type="checkbox"/>	<input type="checkbox"/>	217.0	214.1	145	240	201	15	265	190
250	<input type="checkbox"/>	<input type="checkbox"/>	268.2	265.0	155	295	247	16	311	235
300	<input type="checkbox"/>	<input type="checkbox"/>	319.6	315.5	175	347	298	18	350	170

Notes: 1. conform to the AV standard.

Socket

PRODUCT MODEL CODE	TS	▶	T	N	U	SO	V	N	Size
	HITS	▶	T	N	I	SO	V	N	Size



TS **U-PVC**



HITS **HI-PVC**

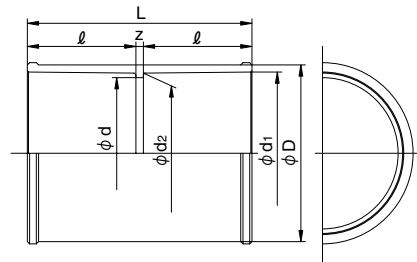

Dimensions Table

(Unit: mm)

Size	TS	HITS	d ₁	d ₂	ℓ	D	d	Z	L
200	<input type="checkbox"/>	<input type="checkbox"/>	217.0	214.1	145	238	202	15	305
250	<input type="checkbox"/>	<input type="checkbox"/>	268.2	265.0	155	295	247	42	352
300	<input type="checkbox"/>	<input type="checkbox"/>	319.6	315.5	175	336	298	10	360

Notes: 1. conform to the AV standard.

Reducing Socket

PRODUCT MODEL CODE

TS ▶ T N U SO V N Size
HITS ▶ T N I SO V N Size



TS
U-PVC



HITS
HI-PVC

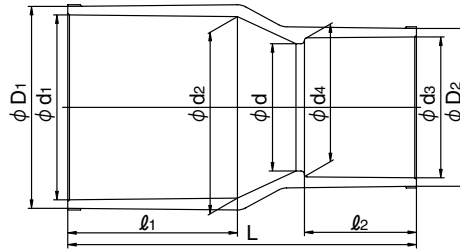

Dimensions Table

(Unit: mm)

Size	TS	HITS	d ₁	d ₂	l ₁	d ₃	d ₄	l ₂	D ₁	D ₂	d	L
200×150	<input type="checkbox"/>	<input type="checkbox"/>	217.0	214.1	145	166.0	163.9	132	240	188	146	356
250×200	<input type="checkbox"/>	<input type="checkbox"/>	268.2	265.0	155	217.0	214.1	145	292	240	194	380
300×250	<input type="checkbox"/>	<input type="checkbox"/>	319.6	315.5	175	268.2	265.0	155	347	295	247	405

Notes: 1. conform to the AV standard.

Tee

PRODUCT MODEL CODE

TS ▶ T N U TE V N Size
HITS ▶ T N I TE V N Size



TS
U-PVC



HITS
HI-PVC

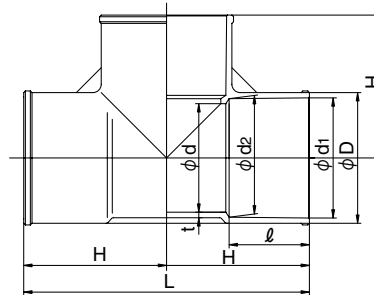

Dimensions Table

(Unit: mm)

Size	TS	HITS	d ₁	d ₂	l	D	d	t	L	H
200	<input type="checkbox"/>	<input type="checkbox"/>	217.0	214.1	145	240	196	15	532	266
250	<input type="checkbox"/>	<input type="checkbox"/>	268.2	265.0	155	295	247	16	662	331
300	<input type="checkbox"/>	<input type="checkbox"/>	319.6	315.5	175	337	298	10	680	340

Notes: 1. conform to the AV standard.

Reducing Tee

PRODUCT MODEL CODE

TS ▶ T N U TE V N Size
HITS ▶ T N I TE V N Size



TS
U-PVC



HITS
HI-PVC

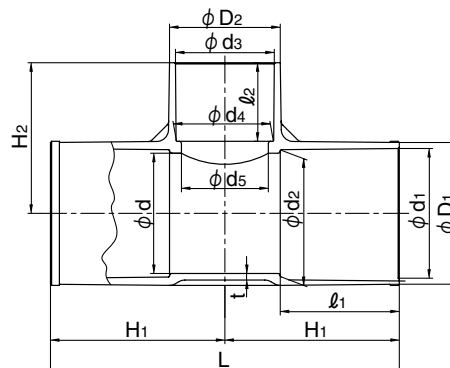

Dimensions Table

(Unit: mm)

Size	TS	HITS	d ₁	d ₂	l ₁	d ₃	d ₄	l ₂	D ₁	D ₂	d	d ₅	t	L	H ₁	H ₂
200×75	<input type="checkbox"/>	<input type="checkbox"/>	217.0	214.1	145	89.6	88.29	64	240	107.2	199	77	15	402	201	180
200×100	<input type="checkbox"/>	<input type="checkbox"/>	217.0	214.1	145	114.7	113.20	84	240	130	199	100	15	430	215	200
200×150	<input type="checkbox"/>	<input type="checkbox"/>	217.0	214.1	145	166.0	163.91	132	240	188	199	146	15	476	238	253
250×75	<input type="checkbox"/>	<input type="checkbox"/>	268.2	265.0	155	89.6	88.29	64	295	108	247	77	16	452	226	210
250×100	<input type="checkbox"/>	<input type="checkbox"/>	268.2	265.0	155	114.7	113.20	84	295	136	247	100	16	492	246	225
250×200	<input type="checkbox"/>	<input type="checkbox"/>	268.2	265.0	155	217.0	214.10	145	295	245	247	194	16	608	304	310
300×75	<input type="checkbox"/>	<input type="checkbox"/>	320.7	314.7	300	89.60	88.29	64	343	102	298	77	17	722	361	236

Notes: 1. conform to the AV standard.

Reducing Socket (Crucial Part FRP Reinforcement Product)

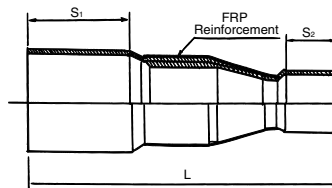

■ Dimensions Table

(Unit: mm)

Size	S ₁	S ₂	L	Size	S ₁	S ₂	L	Size	S ₁	S ₂	L
200×100	200	84	550	300×125	300	104	890	350×250	350	250	920
200×125	200	104	560	300×150	300	132	880	350×300	350	300	880
250×100	250	84	690	300×200	300	200	850	400×200	400	200	1100
250×125	250	104	690	300×250	300	250	790	400×250	400	250	1060
250×150	250	132	690	350×150	350	132	970	400×300	400	300	1040
300×100	300	84	890	350×200	350	200	960	400×350	400	350	980

Notes: 1. L dimension tolerance shall be ± 30 mm.

2. Dimensions other than the normal dimensions above are also available. For details, please contact our nearest office.

Reducing Tee (Crucial Part FRP Reinforcement Product)

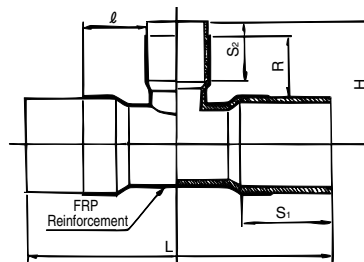

■ Dimensions Table

(Unit: mm)

Size	S ₁	S ₂	H	L	Size	S ₁	S ₂	H	L
200×125	200	104	270	690	350×250	350	250	515	1150
250×125	250	104	300	790	350×300	350	300	565	1200
250×150	250	132	320	810	350×350	350	350	685	1370
300×100	300	84	310	880	400×75	400	64	340	1050
300×125	300	104	340	900	400×100	400	84	360	1070
300×150	300	132	370	940	400×125	400	104	390	1110
300×200	300	200	435	990	400×150	400	132	430	1150
300×250	300	250	485	1050	400×200	400	200	485	1200
350×75	350	64	320	950	400×250	400	250	545	1250
350×100	350	84	330	960	400×300	400	300	595	1300
350×125	350	104	360	990	400×350	400	350	650	1350
350×150	350	132	390	1030	400×400	400	400	760	1520
350×200	350	200	455	1080					

Notes: 1. L dimension tolerance shall be ± 30 mm.

2. Dimensions other than the normal dimensions above are also available. For details, please contact our nearest office.

PRODUCT MODEL CODE LIST

Type	Field	Material	Model	Standard	Others	Size
B	N	U	**	*	N	***
⋮	⋮	⋮	⋮	⋮	⋮	⋮
B Bend	N None Color	U U-PVC	FT Short Flanged End FB Flanged Bend	1 JIS10K 5 JIS5K	N Normal Color	075 75 mm 150 150 mm 100 100 mm 200 200 mm

Short Flanged End

PRODUCT MODEL CODE

B N U FT Standard N Size



U-PVC

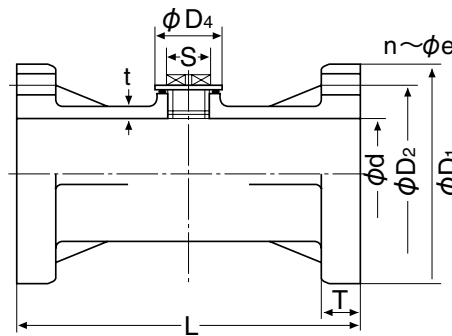

Provided G female threads (3/4 inch) offer a wide variety of usages such as installing a pressure gauge on the pump discharge side and a sample collection port, drainage, air-bleeding or thermometer at a chemical plant.

Dimensions Table

(Unit: mm)

Size	d	D ₁	D ₂	t	T	L	n	e	S	D ₄
75	78	185	150	7.7	22	250	8	19	24	42
100	100	210	175	9.2	22	300	8	19	24	42
150	148	280	240	12.5	26	300	8	23	24	42

Flanged Bend

PRODUCT MODEL CODE

B N U FB Standard N Size



U-PVC

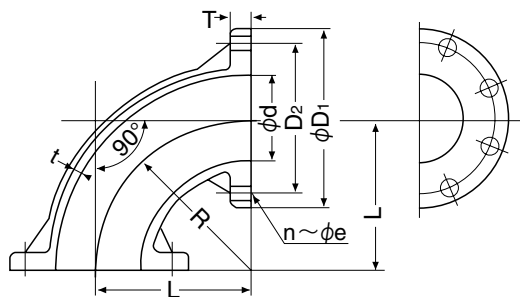

AV flanged bend is designed with an ideal "R" so that the degree of abrasion caused by fluid slurry containing is extremely low. This is also ideal for processes requiring cleaning of pipelines such as food-related, slurry-related and excreta disposal treatment-related with easy installation and removal.

Dimensions Table

(Unit: mm)

Size	d	D ₁	D	T	t	n	e	L	R
100	100	210	175	22	8.5	8	19	180	180
150	148	280	240	26	11.5	8	23	250	250
200	196	330	290	30	13.2	12	23	300	300

PRODUCT MODEL CODE LIST

Type	Field	Material	Model	Standard	Others	Size
W	N	*	**	J	N	***
⋮	⋮	⋮	⋮	⋮	⋮	⋮
W Bend	N None Color	U U-PVC I HI-PVC	9P 90°TS Normal Bend 4P 45°TS Normal Bend 2P 2 1/2°TS Normal Bend 1P 1 1/4°TS Normal Bend 5P 5 5/8°TS Normal Bend	J JIS	N Normal Color	040 40 mm I 300 300 mm

90° TS Normal Bend

Unplasticized Polyvinyl Chloride Pipe Fitting (JIS K6743)

PRODUCT MODEL CODE

TS ▶ W N U 9P J N Size

HITS ▶ W N I 9P J N Size

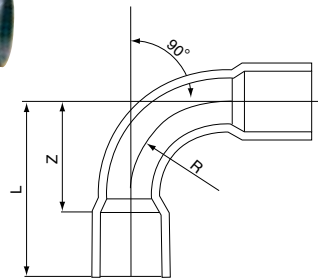
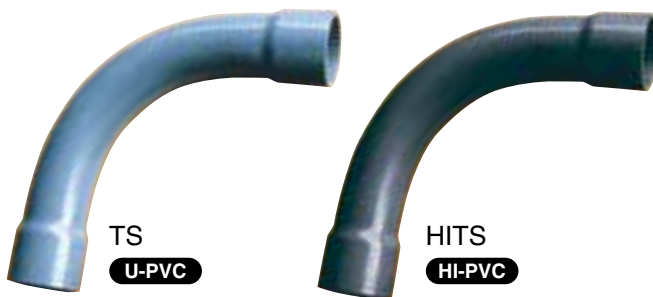

Maximum Working Pressure (Normal Temperature)

40 – 150 mm	1.0MPa
200 – 300 mm	0.75MPa
350 – 400 mm	0.6MPa

Dimensions Table

(Unit: mm)

Size	TS	HITS	Classification	Z	L	R	Size	TS	HITS	Classification	Z	L	R
40	○	—	VP	140	195	110	150	○	□	VP	538	670	475
50	○	□	VP	187	250	150	200	□	—	VP	800	1000	700
65	●	—	VP	249	310	200	250	□	—	VP	1100	1350	1000
75	○	□	VP	306	370	250	300	□	—	VP	1300	1600	1200
100	○	□	VP	361	445	300	350	□	—	VU	1500	1850	1400
125	●	—	VP	461	565	400	400	□	—	VU	1900	2300	1700

Notes: 1. ● conform to the JPPFA standard. 2. □ conform to the AV standard. 3. ○ are accordance with JIS K6743.

45° TS Normal Bend

Unplasticized Polyvinyl Chloride Pipe Fitting (JIS K6743)

PRODUCT MODEL CODE

TS ▶ W N U 4P J N Size

HITS ▶ W N I 4P J N Size

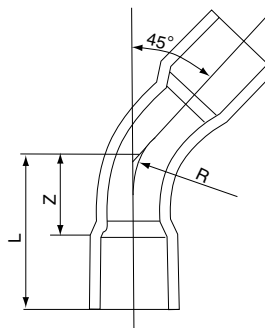
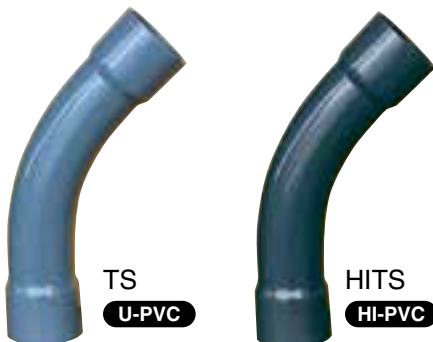

Maximum Working Pressure (Normal Temperature)

40 – 150 mm	1.0MPa
200 – 300 mm	0.75MPa
350 – 400 mm	0.6MPa

Dimensions Table

(Unit: mm)

Size	TS	HITS	Classification	Z	L	R	Size	TS	HITS	Classification	Z	L	R
40	○	—	VP	76	131	110	150	○	○	VP	260	392	475
50	○	○	VP	99	162	150	200	□	—	VP	400	600	700
65	●	—	VP	132	193	200	250	□	—	VP	500	750	1000
75	○	○	VP	160	224	250	300	□	—	VP	600	900	1200
100	○	○	VP	185	269	300	350	□	—	VU	700	1050	1400
125	●	—	VP	227	331	400	400	□	—	VU	800	1200	1700

Notes: 1. ● conform to the JPPFA standard. 2. □ conform to the AV standard. 3. ○ are accordance with JIS K6743.

22 1/2° TS Normal Bend

Unplasticized Polyvinyl Chloride Pipe Fitting (JIS K6743)

PRODUCT MODEL CODE

TS	▶	W	N	U	2P	J	N	Size
HITS	▶	W	N	I	2P	J	N	Size



TS
U-PVC



HITS
HI-PVC

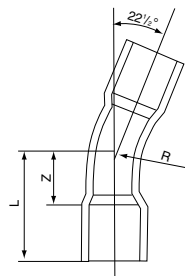

Maximum Working Pressure (Normal Temperature)

40 – 150 mm	1.0MPa
200 – 300 mm	0.75MPa
350 – 400 mm	0.6MPa

Dimensions Table

(Unit: mm)

Size	TS	HITS	Classification	Z	L	R	Size	TS	HITS	Classification	Z	L	R
40	○	—	VP	52	107	110	150	○	○	VP	157	289	475
50	○	○	VP	67	130	150	200	□	—	VP	250	450	700
65	●	—	VP	89	150	200	250	□	—	VP	300	550	1000
75	○	○	VP	106	170	250	300	□	—	VP	350	650	1200
100	○	○	VP	121	205	300	350	□	—	VU	400	750	1400
125	●	—	VP	141	245	400	400	□	—	VU	450	850	1700

Notes: 1. ● conform to the JPPFA standard. 2. □ conform to the AV standard. 3. ○ are accordance with JIS K6743.

11 1/4° TS Normal Bend

Unplasticized Polyvinyl Chloride Pipe Fitting (JIS K6743)

PRODUCT MODEL CODE

TS	▶	W	N	U	1P	J	N	Size
HITS	▶	W	N	I	1P	J	N	Size



TS
U-PVC



HITS
HI-PVC

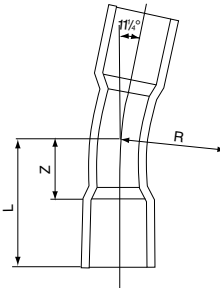

Maximum Working Pressure (Normal Temperature)

40 – 150 mm	1.0MPa
200 – 300 mm	0.75MPa
350 – 400 mm	0.6MPa

Dimensions Table

(Unit: mm)

Size	TS	HITS	Classification	Z	L	R	Size	TS	HITS	Classification	Z	L	R
40	○	—	VP	41	96	110	150	○	○	VP	110	242	475
50	○	○	VP	52	115	150	200	□	—	VP	150	350	700
65	●	—	VP	67	128	200	250	□	—	VP	200	450	1000
75	○	○	VP	81	145	250	300	□	—	VP	200	500	1200
100	○	○	VP	91	175	300	350	□	—	VU	250	600	1400
125	●	—	VP	97	201	400	400	□	—	VU	300	700	1700

Notes: 1. ● conform to the JPPFA standard. 2. □ conform to the AV standard. 3. ○ are accordance with JIS K6743.

5 5/8° TS Normal Bend

Unplasticized Polyvinyl Chloride Pipe Fitting (JIS K6743)

PRODUCT MODEL CODE

TS	▶	W	N	U	5P	J	N	Size
HITS	▶	W	N	I	5P	J	N	Size



TS
U-PVC



HITS
HI-PVC

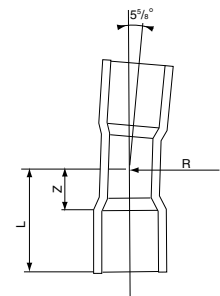

Maximum Working Pressure (Normal Temperature)

40 – 150 mm	1.0MPa
200 – 300 mm	0.75MPa
350 – 400 mm	0.6MPa

Dimensions Table

(Unit: mm)

Size	TS	HITS	Classification	Z	L	R	Size	TS	HITS	Classification	Z	L	R
40	○	—	VP	35	90	110	150	○	○	VP	86	218	475
50	○	○	VP	44	107	150	200	□	—	VP	100	300	700
65	●	—	VP	59	120	200	250	□	—	VP	120	370	1000
75	○	○	VP	68	132	250	300	□	—	VP	140	440	1200
100	○	○	VP	76	160	300	350	□	—	VU	160	510	1400
125	●	—	VP	81	185	400	400	□	—	VU	230	630	1700

Notes: 1. ● conform to the JPPFA standard. 2. □ conform to the AV standard. 3. ○ are accordance with JIS K6743.

PRODUCT MODEL CODE LIST

Type	Field	Material	Model	Standard	Others	Size
R	N	*	**	J	N	***
⋮	⋮	⋮	⋮	⋮	⋮	⋮
R RR Fitting	N None Color	U U-PVC I HI-PVC	9B 90° Bend 4B 45° Bend 2B 22°1/2 Bend 1B 11-1/4° Bend 5B 5-5/8° Bend	J JIS	N Normal Color	040 40 mm I 200 200 mm

90° Bend

Abbreviation: **90BR**

(JWWA 130)

PRODUCT MODEL CODE

TS ▶ R N U 9B J N Size

HITS ▶ R N I 9B J N Size

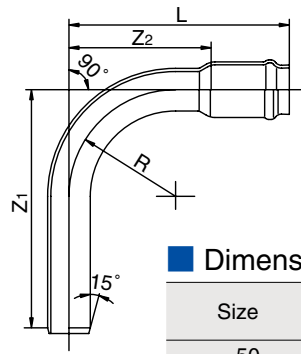
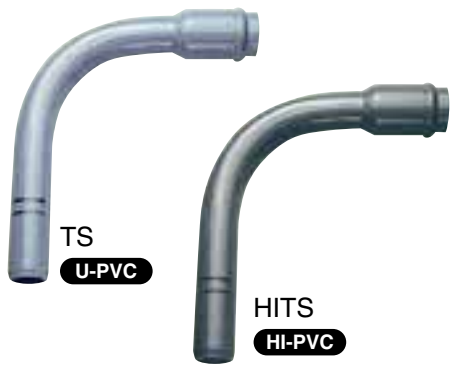

Maximum Working Pressure (Normal Temperature)

50 – 150 mm	1.0MPa
200mm	0.75MPa
U-PVC 250mm	0.6MPa
HI-PVC 250mm	0.75MPa
300mm	0.4MPa

Dimensions Table

(Unit: mm)

Size	TS	VH			
		Z ₁	Z ₂	R	L
50	□	333	200	150	310
75	□	448	305	250	425
100	□	502	360	300	490
150	□	686	530	450	675

Dimensions Table

(Unit: mm)

Size	TS	HITS	VP			
			Z ₁	Z ₂	R	L
50	△	△	335	200	150	310
75	△	△	450	305	250	425
100	△	△	505	360	300	490
125	●	●	615	470	400	605
150	△	△	690	530	450	675
200	□	—	925	690	600	860
250	□	—	1065	805	700	990
300	□	—	1255	960	850	1160

Notes: 1. ● conform to the JPPFA standard. 2. □ conform to the AV standard. 3. △ are accordance with the standard of Japan Water Works Association.

45° Bend

Abbreviation: **45BR**

(JWWA 130)

PRODUCT MODEL CODE

TS ▶ R N U 4B J N Size

HITS ▶ R N I 4B J N Size

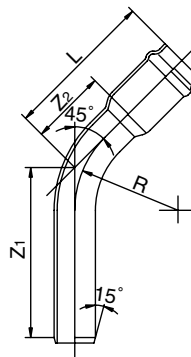
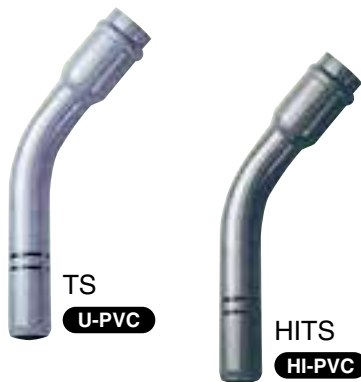

Maximum Working Pressure (Normal Temperature)

50 – 150 mm	1.0MPa
200mm	0.75MPa
U-PVC 250mm	0.6MPa
HI-PVC 250mm	0.75MPa
300mm	0.4MPa

Dimensions Table

(Unit: mm)

Size	TS	VH			
		Z ₁	Z ₂	R	L
50	□	245	110	150	220
75	□	302	160	250	280
100	□	326	185	300	315
150	□	422	265	450	410

Dimensions Table

(Unit: mm)

Size	TS	HITS	VP			
			Z ₁	Z ₂	R	L
50	△	△	247	110	150	220
75	△	△	304	160	250	280
100	△	△	329	185	300	315
125	●	●	381	235	400	370
150	△	△	426	265	450	410
200	□	—	575	340	600	510
250	□	—	655	395	700	580
300	□	—	755	460	850	660

Notes: 1. ● conform to the JPPFA standard. 2. □ conform to the AV standard. 3. △ are accordance with the standard of Japan Water Works Association.

22 1/2° Bend

Abbreviation: **22 1/2 BR**

(JWWA 130)

PRODUCT
MODEL CODE

TS ▶ R N U 2B J N Size

HITS ▶ R N I 2B J N Size



TS
U-PVC



HITS
HI-PVC

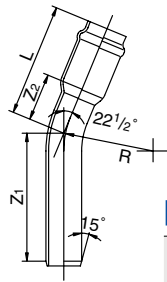

Maximum Working Pressure (Normal Temperature)

50 – 150 mm	1.0MPa
200mm	0.75MPa
U-PVC 250mm	0.6MPa
HI-PVC 250mm	0.75MPa
300 mm	0.4MPa

Dimensions Table

(Unit: mm)

Size	TS	VH			
		Z ₁	Z ₂	R	L
50	<input type="checkbox"/>	213	80	150	190
75	<input type="checkbox"/>	248	105	250	225
100	<input type="checkbox"/>	262	120	300	250
150	<input type="checkbox"/>	326	170	450	315

Dimensions Table

(Unit: mm)

Size	TS	HITS	VP			
			Z ₁	Z ₂	R	L
50	△	△	215	80	150	190
75	△	△	250	105	250	225
100	△	△	265	120	300	250
125	●	●	295	150	400	285
150	△	△	330	170	450	315
200	<input type="checkbox"/>	—	445	210	600	380
250	<input type="checkbox"/>	—	505	245	700	430
300	<input type="checkbox"/>	—	575	280	850	480

Notes: 1. ● conform to the JPPFA standard. 2. conform to the AV standard. 3. △ are accordance with the standard of Japan Water Works Association.

11 1/4° Bend

Abbreviation: **11 1/4 BR**

(JWWA 130)

PRODUCT
MODEL CODE

TS ▶ R N U 1B J N Size

HITS ▶ R N I 1B J N Size



TS
U-PVC



HITS
HI-PVC

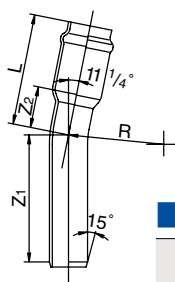

Maximum Working Pressure (Normal Temperature)

50 – 150 mm	1.0MPa
200mm	0.75MPa
U-PVC 250mm	0.6MPa
HI-PVC 250mm	0.75MPa
300mm	0.4MPa

Dimensions Table

(Unit: mm)

Size	TS	VH			
		Z ₁	Z ₂	R	L
50	<input type="checkbox"/>	198	65	150	175
75	<input type="checkbox"/>	223	80	250	200
100	<input type="checkbox"/>	232	90	300	220
150	<input type="checkbox"/>	280	125	450	270

Dimensions Table

(Unit: mm)

Size	TS	HITS	VP			
			Z ₁	Z ₂	R	L
50	△	△	200	65	150	175
75	△	△	225	80	250	200
100	△	△	235	90	300	220
125	●	●	254	110	400	245
150	△	△	284	125	450	270
200	<input type="checkbox"/>	—	385	150	600	320
250	<input type="checkbox"/>	—	435	175	700	360
300	<input type="checkbox"/>	—	485	195	850	395

Notes: 1. ● conform to the JPPFA standard. 2. conform to the AV standard. 3. △ are accordance with the standard of Japan Water Works Association.

5 5/8° Bend

Abbreviation: **5 5/8 BR**

(JWWA 130)

PRODUCT
MODEL CODE

TS ▶ R N U 5B J N Size

HITS ▶ R N I 5B J N Size



TS
U-PVC



HITS
HI-PVC

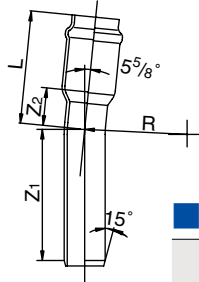

Maximum Working Pressure (Normal Temperature)

50 – 150mm	1.0MPa
200mm	0.75MPa
U-PVC 250mm	0.6MPa
HI-PVC 250mm	0.75MPa
300mm	0.4MPa

Dimensions Table

(Unit: mm)

Size	TS	VH			
		Z ₁	Z ₂	R	L
50	<input type="checkbox"/>	190	55	150	165
75	<input type="checkbox"/>	210	65	250	185
100	<input type="checkbox"/>	217	75	300	205
150	<input type="checkbox"/>	258	100	450	245

Dimensions Table

(Unit: mm)

Size	TS	HITS	VP			
			Z ₁	Z ₂	R	L
50	△	△	192	55	150	165
75	△	△	212	65	250	185
100	△	△	220	75	300	205
125	●	●	235	90	400	245
150	△	△	262	100	450	245
200	<input type="checkbox"/>	—	355	120	600	290
250	<input type="checkbox"/>	—	400	140	700	325
300	<input type="checkbox"/>	—	445	150	850	350

Notes: 1. ● conform to the JPPFA standard. 2. conform to the AV standard. 3. △ are accordance with the standard of Japan Water Works Association.

PRODUCT MODEL CODE LIST

Type	Field	Model	Material	Standard	Size
F	N	T	*	*	***
⋮	⋮	⋮	⋮	⋮	⋮
F Flange	N None Color	T TS Flange	U U-PVC I HI-PVC	1 JIS10K 5 JIS5K W Waterworks A ANSI	013 13 mm I 350 350 mm

TS Flange

PRODUCT MODEL CODE	U-PVC	JIS 10K	F	N	T	U	1	Size
	HI-PVC	JIS 10K	F	N	T	I	1	Size
	U-PVC	JIS 5K	F	N	T	U	5	Size
	HI-PVC	JIS 5K	F	N	T	I	5	Size



Maximum Working Pressure (Normal Temperature)

JIS 10K	13 – 300mm	1.0MPa
	350mm	0.6MPa
JIS 5K	13 – 350 mm	0.5MPa

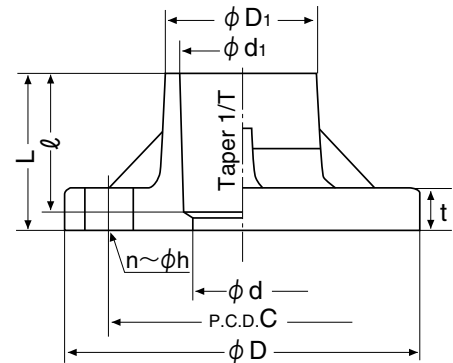

U-PVC JIS 10K 13 – 350 mm, JIS 5K 13 – 350 mm
 HI-PVC JIS 10K 13 – 300 mm, JIS 5K 13 – 200 mm

Dimensions Table

(Unit: mm)

Size	d		d ₁		Taper 1/T		ℓ		D ₁		C		D		pcs.		h		t		L	
	10K	5K	10K	5K	10K	5K	10K	5K	10K	5K	10K	5K	10K	5K	10K	5K	10K	5K	10K	5K	10K	5K
13	13.5	15	18.40		1/30		26	25.5	24	65	55	90	75	4	4	15	12	14	9	30	30	
15	16.5	18	22.40		1/34		30	31	29	70	60	95	80	4	4	15	12	14	9	35	35	
20	20.5	22	26.45		1/34		35	35	33	75	65	100	85	4	4	15	12	15	10	40	40	
25	25	25	32.55		1/34		40	42.5	40	90	75	125	95	4	4	19	12	15	10	46	45	
32	30	30	38.60		1/34		44	48.5	46	100	90	135	115	4	4	19	15	16	12	50.5	50	
40	41	41	48.70		1/37		55	60.5	59	105	95	140	120	4	4	19	15	16	12	61.5	61	
50	52	52	60.80		1/37		63	73	70	120	105	155	130	4	4	19	15	20	14	71	72	
65	67	67	76.60	76.80	1/48	1/41	61	69	90	86	140	130	175	155	4	4	19	15	22	14	70	76
80	78	78	89.60	89.80	1/49	1/43	64	72	105	101	150	145	185	180	8	4	19	19	22	14	73	80
100	100	100	114.70	115.00	1/56	1/44	84	92	131	129	175	165	210	200	8	8	19	19	22	16	93	105
125	125	125	140.85	141.20	1/58	1/45	104	112	158	156	210	200	250	235	8	8	23	19	24	16	114	126
150	146	146	166.00	166.50	1/63	1/45	132	140	185	185	240	230	280	265	8	8	23	19	26	18	142	150
200	196	196	217.00		1/50		145	238	238	290	280	330	320	12	8	23	23	28	28	156	156	
250	247	247	268.20		1/55		155	300	300	355	345	400	385	12	12	25	23	30	30	167	167	
300	298	298	318.70		1/55		155	341	341	400	390	445	430	16	12	25	23	30	30	167	167	
350	348	348	371.00		1/60		230	398	398	445	435	490	480	16	12	25	23	34	34	300	300	

Notes: Dimensions for C, D, n and h are accordance with the JIS 10K · 5K standards. Bolt hole dimension for 5K (350 mm) is different from JIS. Use M20 for tightening bolts.

For U-PVC Waterworks, HI-PVC Waterworks, U-PVC ANSI Standard

PRODUCT MODEL CODE	U-PVC Waterworks	F	N	T	U	W	Size
	HI-PVC Waterworks	F	N	T	I	W	Size
	U-PVC For ANSI Standard	F	N	T	U	A	Size

Maximum Working Pressure (Normal Temperature)

Waterworks	50 – 300 mm	0.75MPa
ANSI	15 – 300 mm	1.0MPa



U-PVC



HI-PVC

U-PVC Waterworks 50 – 300 mm HI-PVC Waterworks 75 – 250 mm

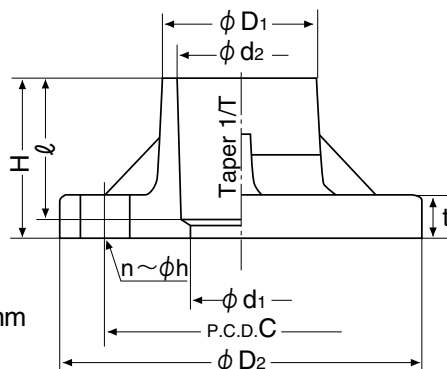

Dimensions Table

(Unit: mm)

Size	d1	d2	Taper 1/T	ℓ	D1	C	D2	pcs.	h	t	H
50	52	60.80	1/37	63	73	120	155	4	19	20	71
75(80)	78	89.60	1/49	64	107	168	211	4	19	22	74
100	100	114.70	1/56	84	133	195	238	4	19	24	98
125	125	140.85	1/58	104	159	220	263	6	19	24	118
150	146	166.00	1/63	132	185	247	290	6	19	24	147
200	196	217.00	1/50	145	238	299	342	8	19	28	156
250	247	268.20	1/55	155	300	360	410	8	23	30	167
300	298	318.70	1/55	155	341	414	464	10	23	30	167

Notes: 1. Dimensions for C, D2, n and h of 75 (80) to 300 mm are accordance with the tap water gate valve of JIS B 2062.

2. C, D2, n and h for 50 mm are accordance with the JIS 10K standard.

Use the JIS 10K standard for TS flange to connect to 65 mm gate valve.

For U-PVC ANSI Standard

Dimensions Table

(Unit: mm)

Size	d1	d2	Taper 1/T	ℓ	D1	C	D2	pcs.	h	t	H
15	18	22.40	1/34	30	31	60.5	89	4	16	12	46
20	22	26.45	1/34	35	35	70	98	4	16	13	53
25	25	32.55	1/34	40	42.5	79.5	108	4	16	15	50
32	30	38.60	1/34	44	48.5	89	117.5	4	16	16	54
40	41	48.70	1/37	55	60.5	98.5	127	4	16	18	65
50	52	60.80	1/37	63	73	120.5	152	4	19	20	74
65	67	76.80	1/41	69	90	139.5	178	4	19	23	82
80	78	89.80	1/43	72	105	152.5	190.5	4	19	24	86
100	100	115.00	1/44	92	131	190.5	229	8	19	24	107
125	125	141.20	1/45	112	158	216	254	8	22	24	130
150	146	166.50	1/45	140	185	241.5	280	8	22	26	142
200	196	217.00	1/50	145	238	298.5	343	8	22	28	156
250	247	268.20	1/55	155	300	362	406	12	25	30	167
300	298	318.70	1/55	155	341	432	483	12	25	30	167

Notes: 1. Only C, D2, n and h are accordance with ANSI/ASME B 16.5 CLASS 150.

2. For pipe socket dimension, d1, ℓ and taper 1/T are accordance with the JIS standard. (JIS K 6743)

PRODUCT MODEL CODE LIST

Type	Field	Model	Material	Standard	Size
F	N	*	*	*	***
⋮	⋮	⋮	⋮	⋮	⋮
F Flange	N None Color	J J Flange P P Flange Q Q Flange	U U-PVC I HI-PVC	1 JIS 10K 5 JIS 5K	013 13 mm 1 300 300 mm

Welded Flange

PRODUCT MODEL CODE

U-PVC	JIS 10K	F	N	J	U	1	Size
U-PVC	JIS 5K	F	N	J	U	5	Size

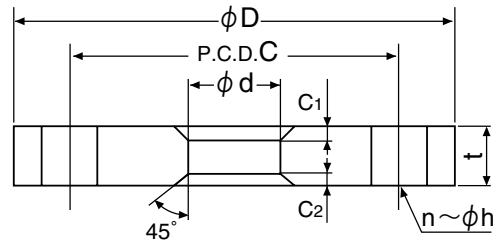
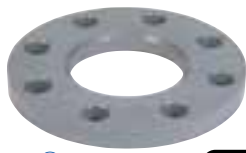

Blind Flange

PRODUCT MODEL CODE

U-PVC		P	F	N	P	U	Standard	Size
U-PVC	JIS 10K	Q	F	N	Q	U	1	Size
HI-PVC	JIS 10K	Q	F	N	Q	I	1	Size
U-PVC	JIS 5K	Q	F	N	Q	U	5	Size

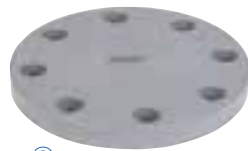

Maximum Working Pressure (Normal Temperature)

JIS 10K	13 - 150 mm	1.0MPa
	200 - 300 mm	0.5MPa
JIS 5K	13 - 300 mm	0.5MPa

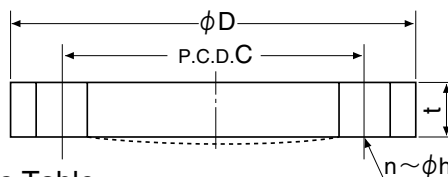

Dimensions Table

(Unit: mm)

Size	d	C		D		pcs.		h		t		C ₁	C ₂
		10K	5 K	10K	5 K	10K	5 K	10K	5 K				
13	18	65	55	90	75	4	4	15	12	12	9	3	3
15	22	70	60	95	80	4	4	15	12	12	9	3	3
20	26	75	65	100	85	4	4	15	12	14	10	3	3
25	32	90	75	125	95	4	4	19	12	14	10	3	3
32	38	100	90	135	115	4	4	19	15	16	12	3	3
40	48	105	95	140	120	4	4	19	15	16	12	3	3
50	60	120	105	155	130	4	4	19	15	16	14	3	4
65	76	140	130	175	155	4	4	19	15	18	14	3	4
80	89	150	145	185	180	8	4	19	19	18	14	3	4
100	114	175	165	210	200	8	8	19	19	18	16	3	4
125	140	210	200	250	235	8	8	23	19	20	16	4	4
150	165	240	230	280	265	8	8	23	19	22	18	4	4
200	216	290	280	330	320	12	8	23	23	22	20	4	4
250	267	355	345	400	385	12	12	25	23	24	22	4	4
300	318	400	390	445	430	16	12	25	23	24	22	4	4

Notes: Dimensions for C, D, n and h are accordance with the JIS 10K · 5K standards.

PRODUCT MODEL CODE LIST

Type	Field	Material	Model	Standard	Others	Size
D	N	U	**	J	N	***
D DV Fitting	N None Color	U U-PVC	DL DV-DL 90° Elbow LL DV-LL 90° Large-Bend Elbow 4L DV-45L 45° Elbow DT DV-90Y 90°Y LT DV-LT 90° Large-Bend Y 4Y DV-45Y 45°Y WT DV-WLT 90° Large-bend Both Y DS DV-DS Socket IN DV-IN Increaser	J JIS	N Normal Color	030 30 mm 150 150 mm 040030 40x30 mm 150125 150x125 mm

DV Fitting Socket, Other Common Dimensions

●JIS K6739

Drainage Unplasticized Polyvinyl Chloride Pipe & Fitting

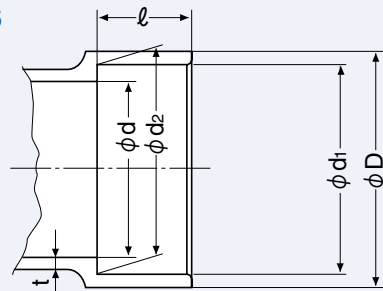

Dimensions Table

(Unit: mm)

Size	d1		d2		l		D	d		t Min Dimension
	Basic Dimension	Tolerance	Basic Dimension	Tolerance	Basic Dimension	Tolerance		Min Dimension	Basic Dimension	
30	38.25	±0.25	37.85	±0.25	18	±1	44	31.0	±0.8	2.7
40	48.30	±0.30	47.80	±0.30	22	±1	54	40.0	±0.9	2.7
50	60.35	±0.30	59.75	±0.30	25	±1	67	51.0	±0.9	3.1
65	76.40	±0.30	75.70	±0.30	35	±1	83	67.0	±0.9	3.1
75	89.45	±0.30	88.65	±0.30	40	±2	97	77.2	±0.9	3.6
100	114.55	±0.35	113.55	±0.35	50	±2	124	98.8	±1.0	4.5
125	140.70	±0.40	139.40	±0.40	65	±2	151	125.0	±1.2	5.4
150	165.85	±0.45	164.25	±0.45	80	±2	178	145.8	±1.3	6.3

90° Elbow

Abbreviation: **DL**

(JIS K 6739)

PRODUCT MODEL CODE

DL ▶ D N U DL J N Size



U-PVC

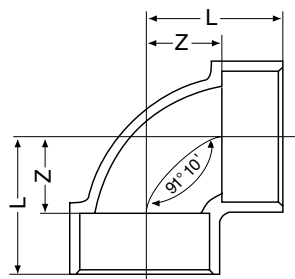

Dimensions Table

(Unit: mm)

Size	Z	L	Size	Z	L
▲ 30	22	40	75	48	88
40	27	49	100	62	112
50	33	58	125	75	140
65	42	77	150	88	168

Notes: 1. Z tolerance shall be ±2 mm. 2. Flow angle 91°10' tolerance shall be ±30'. 3. ▲ are stock products.

90° Large-Bend Elbow

Abbreviation: **LL**

(JIS K 6739)

PRODUCT
MODEL CODE

LL ▶ D N U LL J N Size



U-PVC

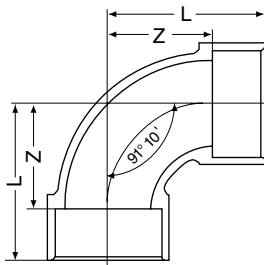

Dimensions Table

(Unit: mm)

Size	Z	L
40	52	74
50	66	91
65	90	125
75	100	140

Size	Z	L
100	128	178
125	140	205
150	170	250

Notes: 1. Z tolerance shall be ± 2 mm. 2. Flow angle $91^{\circ}10'$ tolerance shall be $\pm 30'$.

45° Elbow

Abbreviation: **45L**

(JIS K 6739)

PRODUCT
MODEL CODE

45L ▶ D N U 4L J N Size



U-PVC

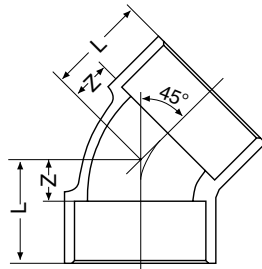

Dimensions Table

(Unit: mm)

Size	Z	L
▲ 30	12	30
40	14	36
50	18	43
65	22	57

Size	Z	L
75	25	65
100	30	80
125	38	103
150	44	124

Notes: 1. Z tolerance shall be ± 2 mm. 2. ▲ are stock products.

90°Y

Abbreviation: **DT**

(JIS K 6739)

PRODUCT
MODEL CODE

DT ▶ D N U DT J N Size



U-PVC

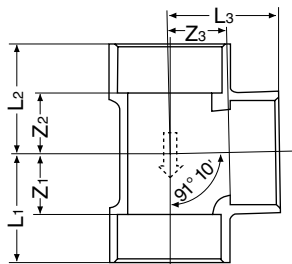

Dimensions Table

(Unit: mm)

Size	Z ₁	Z ₂	Z ₃	L ₁	L ₂	L ₃
▲ 30	22	22	22	40	40	40
40	27	27	27	49	49	49
50	34	34	34	59	59	59
65	42	43	42	77	78	77

Size	Z ₁	Z ₂	Z ₃	L ₁	L ₂	L ₃
75	48	49	48	88	89	88
100	62	63	62	112	113	112
125	75	76	75	140	141	140
150	89	90	89	169	170	169

Notes: 1. Tolerance of Z₁, Z₂ and Z₃ shall be ± 2 mm. 2. Flow angle $91^{\circ}10'$ tolerance shall be $\pm 30'$.

3. An arrow to show direction of flow shall be embossed on the surface as shown in the diagram. 4. ▲ are stock products.

Reducing 90°Y

Abbreviation: **DT**

(JIS K 6739)

PRODUCT
MODEL CODE

DT ▶ D N U DT J N Size



U-PVC

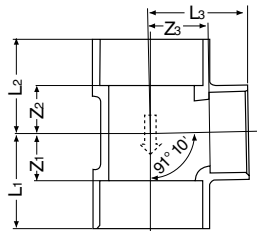

Dimensions Table

(Unit: mm)

Size	Z ₁	Z ₂	Z ₃	L ₁	L ₂	L ₃
▲ 50× 30	22	22	33	47	47	51
▲ 50× 40	27	27	33	52	52	55
▲ 65× 40	27	28	42	62	63	64
65× 50	34	35	42	69	70	67
75× 40	27	28	48	67	68	70
75× 50	34	35	48	74	75	73
75× 65	42	43	48	82	83	83

Size	Z ₁	Z ₂	Z ₃	L ₁	L ₂	L ₃
100× 40	27	28	62	77	78	84
100× 50	34	35	62	84	85	87
100× 65	42	43	62	92	93	97
100× 75	48	49	62	98	99	102
□ 125× 75	49	51	75	114	116	115
□ 125×100	62	64	75	127	129	125
□ 150× 75	51	53	88	131	135	128
□ 150×100	62	65	88	142	145	138

Notes: 1. Tolerance of Z₁, Z₂ and Z₃ shall be ±2 mm. 2. Flow angle 91°10' tolerance shall be ±30'.

3. An arrow to show direction of flow shall be embossed on the surface as shown in the diagram. 4. □ conform to the AV standard. 5. ▲ are stock products.

90° Large-Bend Y

Abbreviation: **LT**

(JIS K 6739)

PRODUCT
MODEL CODE

LT ▶ D N U LT J N Size



U-PVC

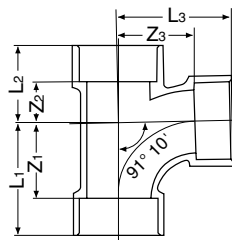

Dimensions Table

(Unit: mm)

Size	Z ₁	Z ₂	Z ₃	L ₁	L ₂	L ₃
40	52	23	52	74	45	74
50	66	26	66	91	51	91
65	90	33	90	125	68	125
75	100	30	100	140	70	140

Size	Z ₁	Z ₂	Z ₃	L ₁	L ₂	L ₃
100	128	45	128	178	95	178
125	140	50	140	205	115	205
150	170	65	170	250	145	250

Notes: 1. Tolerance of Z₁, Z₂ and Z₃ shall be ±2 mm. 2. Flow angle 91°10' tolerance shall be ±30'.

Reducing 90° Large-Bend Y

Abbreviation: **LT**

(JIS K 6739)

PRODUCT
MODEL CODE

LT ▶ D N U LT J N Size



U-PVC

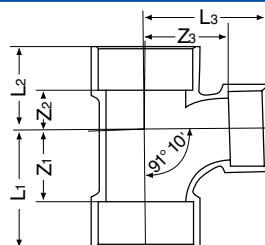

Dimensions Table

(Unit: mm)

Size	Z ₁	Z ₂	Z ₃	L ₁	L ₂	L ₃
50× 40	52	23	57	77	48	79
65× 40	52	24	66	87	59	88
65× 50	66	27	74	101	62	99
75× 40	52	25	71	92	65	93
75× 50	66	29	79	106	69	104
75× 65	90	32	95	130	72	130
100× 40	52	28	82	102	78	104
100× 50	66	32	90	116	82	115
100× 65	90	36	107	140	86	142
100× 75	100	33	110	150	83	150

Size	Z ₁	Z ₂	Z ₃	L ₁	L ₂	L ₃
125× 65	90	38	120	155	103	155
125× 75	100	42	124	165	107	164
125×100	128	52	140	193	117	190
150× 65	90	42	130	170	122	165
150× 75	100	45	135	180	125	175
150×100	128	53	152	208	133	202
150×125	140	60	152	220	140	217

Notes: 1. Tolerance of Z₁, Z₂ and Z₃ shall be ±2 mm.

2. Flow angle 91°10' tolerance shall be ±30'.

45°Y

Abbreviation: **Y**

(JIS K 6739)

PRODUCT
MODEL CODE

Y ▶ D N U 4Y J N Size



U-PVC

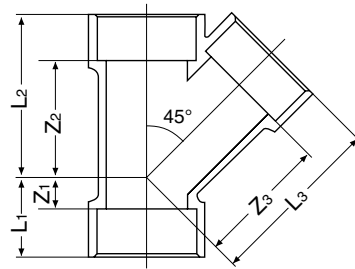

Dimensions Table

(Unit: mm)

Size	Z ₁	Z ₂	Z ₃	L ₁	L ₂	L ₃
40	12	58	62	34	80	84
50	20	72	78	45	97	103
65	20	92	98	55	127	133
75	26	106	115	66	146	155

Size	Z ₁	Z ₂	Z ₃	L ₁	L ₂	L ₃
100	32	134	144	82	184	194
125	38	172	175	103	237	240
150	44	204	210	124	284	290

Notes: 1. Tolerance of Z₁, Z₂ and Z₃ shall be ±2 mm.

Reducing 45°Y

Abbreviation: **Y**

(JIS K 6739)

PRODUCT
MODEL CODE

Y ▶ D N U 4Y J N Size



U-PVC

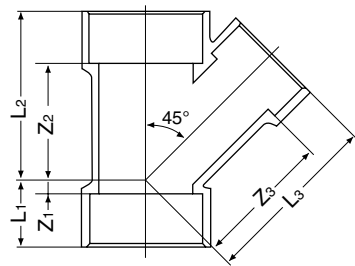

Dimensions Table

(Unit: mm)

Size	Z ₁	Z ₂	Z ₃	L ₁	L ₂	L ₃
50× 40	8	62	70	33	87	97
65× 40	-1	72	82	34	107	104
65× 50	8	80	88	43	115	113
75× 40	-6	78	92	34	118	114
75× 50	3	86	98	43	126	123
75× 65	14	98	106	54	138	141

Size	Z ₁	Z ₂	Z ₃	L ₁	L ₂	L ₃
100× 40	-14	96	112	36	146	134
100× 50	-8	98	118	42	148	143
100× 65	3	110	125	53	160	160
100× 75	19	118	132	69	168	172
125×100	19	150	171	84	215	221
150×100	6	165	185	86	245	235

Notes: 1. Tolerance of Z₁, Z₂ and Z₃ shall be ±2 mm.

90° Large-Bend Both Y

Abbreviation: **WLT**

(JIS K 6739)

PRODUCT
MODEL CODE

WLT ▶ D N U WT J N Size



U-PVC

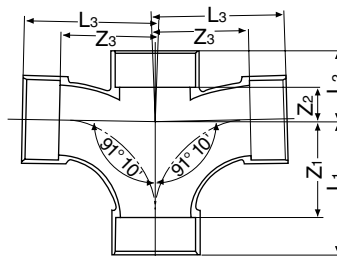

Dimensions Table

(Unit: mm)

Size	Z ₁	Z ₂	Z ₃	L ₁	L ₂	L ₃
▲ 65	90	33	90	125	68	125
75	100	38	100	140	78	140
100	128	45	128	178	95	178

Notes: 1. Tolerance of Z₁, Z₂ and Z₃ shall be ±2 mm.

2. Flow angle 91°10' tolerance shall be ±30'.

3. ▲ are stock products.

Reducing 90° Large-bend Both Y

Abbreviation: **WLT**

(JIS K 6739)

PRODUCT
MODEL CODE

WLT ▶ D N U WT J N Size



U-PVC

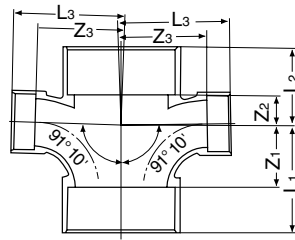

Dimensions Table

(Unit: mm)

Size	Z ₁	Z ₂	Z ₃	L ₁	L ₂	L ₃
100×75	100	40	110	150	90	150
125×100	128	52	140	193	117	190

- Notes: 1. Tolerance of Z₁, Z₂ and Z₃ shall be ±2 mm.
2. Flow angle 91°10' tolerance shall be ±30'.

Socket

Abbreviation: **DS**

(JIS K 6739)

PRODUCT
MODEL CODE

DS ▶ D N U DS J N Size



U-PVC

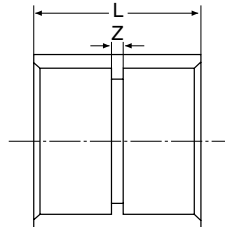

Dimensions Table

(Unit: mm)

Size	Z	L
40	3	47
50	3	53
65	3	73
75	4	84

Size	Z	L
100	4	104
125	4	134
150	4	164

- Notes: 1. Z tolerance shall be ±2 mm.

Increaser

Abbreviation: **IN**

(JIS K 6739)

PRODUCT
MODEL CODE

IN ▶ D N U IN J N Size

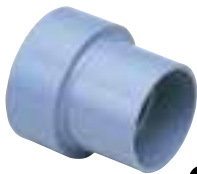

U-PVC

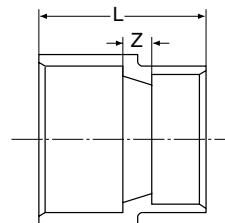

Dimensions Table

(Unit: mm)

Size	Z	L
▲ 40×30	20	60
50×40	20	67
65×40	20	77
65×50	20	80
▲ 75×40	25	87
75×50	25	90
75×65	25	100
100×40	30	102
▲ 100×50	30	105
100×65	30	115
100×75	30	120

Size	Z	L
▲ □ 125×65	35	135
□ 125×75	35	140
125×100	35	150
□ 150×75	40	160
150×100	40	170
150×125	40	185

- Notes: 1. Z tolerance shall be ±2 mm.
2. □ conform to the AV standard.
3. ▲ are stock products.

PRODUCT MODEL CODE LIST

Type	Field	Material	Model	Standard	Others	Size
D	N	U	**	U	N	***
D VU Fitting	N None Color	U U-PVC	DL VU-DL 90° Elbow 4L VU-45L 45° Elbow DS VU-DS Socket IN VU-IN Increaser DT VU-DT 90°Y LL VU-LL 90° Large-Bend Elbow 4Y VU-Y 45°Y LT VU-LT 90° Large-Bend Y	U VU	N Normal Color	040 40 mm 150 150 mm 050040 50×40 mm 150125 150×125 mm

VU Fitting Socket Common Dimensions

This is used for non-pressurized piping such as drainage and sewer piping.

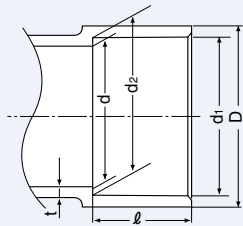

Dimensions Table

(Unit: mm)

Size	d ₁		d ₂		l		d	t	D
	Basic Dimension	Tolerance	Basic Dimension	Tolerance	Basic Dimension	Tolerance	Min Dimension	Min Dimension	Reference Dimension
40	48.3	±0.3	47.8	±0.3	22	±1	44	2.0	54
50	60.5	±0.3	59.5	±0.3	25	±3	56	2.2	67
65	76.6	±0.3	75.4	±0.3	35	±3	71	2.5	83
75	89.6	±0.3	88.3	±0.3	40	±5	83	3.0	97
100	114.8	±0.4	113.2	±0.4	50	±5	107	3.5	124
125	140.9	±0.4	139.1	±0.4	65	±5	131	4.5	151
150	166.1	±0.5	163.9	±0.5	80	±5	154	5.5	178

Notes: 1. d₁ and d₂ shall be the average of measured inner diameters of 2 directions or more perpendicular to each other.

90° Elbow

Abbreviation: **VU-DL**

(JPPFA AS38)

VU-DL ▶ **D N U DL U N** Size



U-PVC

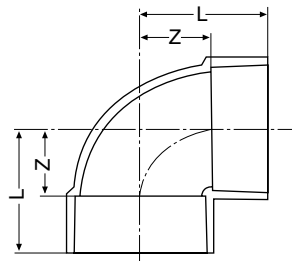

Dimensions Table

(Unit: mm)

Size	Z	L	Size	Z	L
□ 40	27	49	● 100	62	112
● 50	33	58	□ 125	75	140
● 65	42	77	● 150	88	168
● 75	48	88			

Notes: 1. Z tolerance shall be ±2 mm. 2. L is the normal dimension. 3. ● conform to the JPPFA standard. 4. □ conform to the AV standard.

45° Elbow

Abbreviation: **VU-45L**

(JPPFA AS38)

VU-45L ▶ **D N U 4L U N** Size



U-PVC

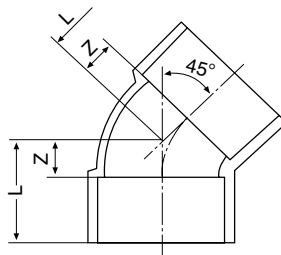

Dimensions Table

(Unit: mm)

Size	Z	L	Size	Z	L
□ 40	14	36	● 100	30	80
● 50	18	43	□ 125	38	103
● 65	22	57	● 150	44	124
● 75	25	65			

Notes: 1. Z tolerance shall be ±2 mm. 2. L is the normal dimension. 3. ● conform to the JPPFA standard. 4. □ conform to the AV standard.

Socket

Abbreviation: **VU-DS**

(JPPFA AS38)

PRODUCT MODEL CODE

VU-DS ▶ **D N U DS U N** Size



U-PVC

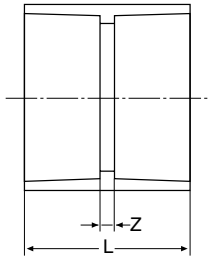

Dimensions Table

(Unit: mm)

Size	Z	L
□ 40	3	47
● 50	3	53
● 65	3	73
● 75	4	84

Size	Z	L
● 100	5	105
□ 125	5	135
● 150	5	165

Notes: 1. Z tolerance shall be ± 2 mm. 2. L is the normal dimension. 3. ● conform to the JPPFA standard. 4. □ conform to the AV standard.

Increaser

Abbreviation: **VU-IN**

(JPPFA AS38)

PRODUCT MODEL CODE

VU-IN ▶ **D N U IN U N** Size

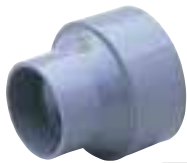

U-PVC

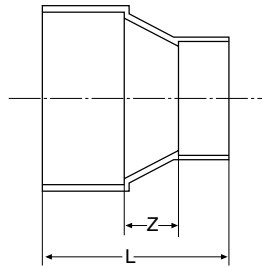

Dimensions Table

(Unit: mm)

Size	Z	L
□ 50x 40	20	67
□ 65x 50	20	80
● 75x 50	25	90
● 75x 65	25	100
● 100x 50	30	105
● 100x 65	30	115
● 100x 75	30	120

Size	Z	L
● 125x100	35	150
● 150x100	40	170
150x125	40	185

Notes: 1. Z tolerance shall be ± 2 mm.
2. ● conform to the JPPFA standard.
3. □ conform to the AV standard.

90°Y

Abbreviation: **VU-DT**

(JPPFA AS38)

PRODUCT MODEL CODE

VU-DT ▶ **D N U DT U N** Size



U-PVC

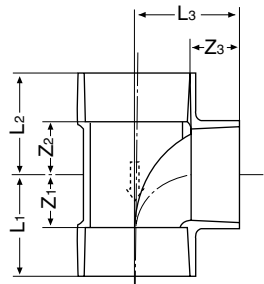

Dimensions Table

(Unit: mm)

Size	Z ₁	Z ₂	Z ₃	L ₁	L ₂	L ₃
● 50	34	34	34	59	59	59
● 65	42	43	42	77	78	77
● 75	48	49	48	88	89	88

Size	Z ₁	Z ₂	Z ₃	L ₁	L ₂	L ₃
● 100	62	63	62	112	113	112
□ 125	75	76	75	140	141	140
● 150	89	90	89	169	170	169

Notes: 1. Tolerance of Z₁, Z₂ and Z₃ shall be ± 2 mm. 2. An arrow to show direction of flow shall be embossed on the outside as shown in the diagram.
3. ● conform to the JPPFA standard. 4. □ conform to the AV standard.

Reducing 90°Y

Abbreviation: **VU-DT**

(JPPFA AS38)

PRODUCT
MODEL CODE

VU-DT ▶ D N U DT U N Size



U-PVC

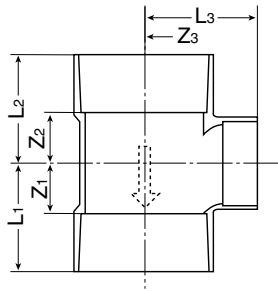

Dimensions Table

(Unit: mm)

Size	Z ₁	Z ₂	Z ₃	L ₁	L ₂	L ₃
● 75×50	34	35	48	74	75	73
□ 75×65	42	43	48	82	83	83

Size	Z ₁	Z ₂	Z ₃	L ₁	L ₂	L ₃
● 100×50	34	35	62	84	85	87
● 100×75	48	49	62	98	99	102
□ 150×100	62	63	88	142	143	138

Notes: 1. Tolerance of Z₁, Z₂ and Z₃ shall be ±2 mm. 2. An arrow to show direction of flow shall be embossed on the outside as shown in the diagram.
3. ● conform to the JPPFA standard. 4. □ conform to the AV standard.

90° Large-Bend Elbow

Abbreviation: **VU-LL**

(JPPFA AS38)

PRODUCT
MODEL CODE

VU-LL ▶ D N U LL U N Size



U-PVC

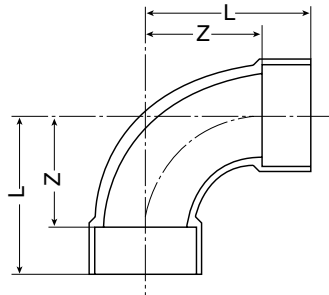

Dimensions Table

(Unit: mm)

Size	Z	L
● 50	66	91
● 75	100	140
● 100	128	178

Size	Z	L
● 125	140	205
● 150	170	250

Notes: 1. Z tolerance shall be ±2 mm for the size of 100 or less and ±3 mm for the size of 125 or more. 2. ● conform to the JPPFA standard.

45°Y

Abbreviation: **VU-Y**

(JPPFA AS38)

PRODUCT
MODEL CODE

VU-Y ▶ D N U 4Y U N Size



U-PVC

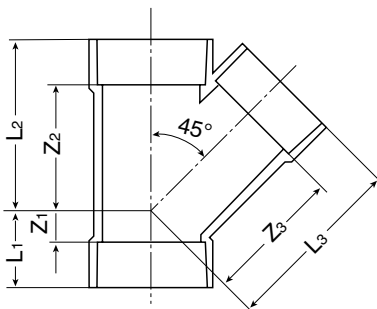

Dimensions Table

(Unit: mm)

Size	Z ₁	Z ₂	Z ₃	L ₁	L ₂	L ₃
● 50	20	72	78	45	97	103
● 75	26	106	115	66	146	155
● 100	32	134	144	82	184	194

Size	Z ₁	Z ₂	Z ₃	L ₁	L ₂	L ₃
□ 125	38	172	175	103	237	240
● 150	44	204	210	124	284	290

Notes: 1. Tolerance of Z₁, Z₂ and Z₃ shall be ±2 mm for the size of 100 or less and ±3 mm for the size of 150.
2. ● conform to the JPPFA standard. 3. □ conform to the AV standard.

Reducing 45°Y

Abbreviation: **VU-Y**

(JPPFA AS38)

PRODUCT
MODEL CODE

VU-Y ▶ D N U 4Y U N Size



U-PVC

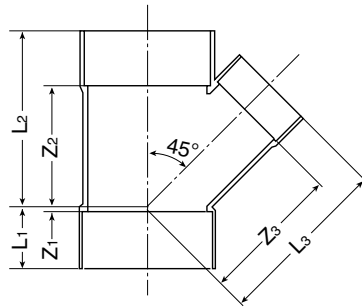

Dimensions Table

(Unit: mm)

Size	Z ₁	Z ₂	Z ₃	L ₁	L ₂	L ₃
● 75×50	3	86	98	43	126	123
● 100×50	-8	98	118	42	148	143
● 100×75	19	118	132	69	168	172

Notes: 1. Tolerance of Z₁, Z₂ and Z₃ shall be ±2 mm.
2. ● conform to the JPPFA standard.

90° Large-Bend Y

Abbreviation: **VU-LT**

(JPPFA AS38)

PRODUCT
MODEL CODE

VU-LT ▶ D N U LT U N Size



U-PVC

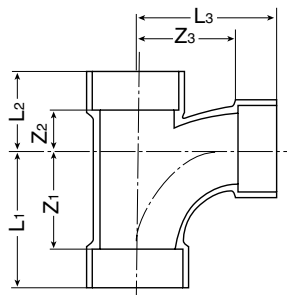

Dimensions Table

(Unit: mm)

Size	Z ₁	Z ₂	Z ₃	L ₁	L ₂	L ₃
● 50	66	26	66	91	51	91
● 75	100	30	100	140	70	140
● 100	128	45	128	178	95	178

Size	Z ₁	Z ₂	Z ₃	L ₁	L ₂	L ₃
● 125	140	50	140	205	115	205
▲● 150	170	65	170	250	145	250

Notes: 1. Tolerance of Z₁, Z₂ and Z₃ shall be ±2 mm for the size of 100 or less and ±3 mm for the size of 125 or more.
2. ● conform to the JPPFA standard. 3. ▲ are stock products.

Reducing 90° Large-Bend Y

Abbreviation: **VU-LT**

(JPPFA AS38)

PRODUCT
MODEL CODE

VU-LT ▶ D N U LT U N Size



U-PVC

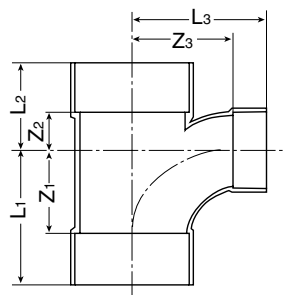

Dimensions Table

(Unit: mm)

Size	Z ₁	Z ₂	Z ₃	L ₁	L ₂	L ₃
□ 65×50	66	27	74	101	62	99
● 75×50	66	29	79	106	69	104
□ 75×65	90	32	95	130	72	130

Size	Z ₁	Z ₂	Z ₃	L ₁	L ₂	L ₃
● 100×50	66	32	90	116	82	115
● 100×75	100	33	110	150	83	150
□ 125×100	128	52	140	193	117	190
● 150×125	140	60	152	220	140	217

Notes: 1. Tolerance of Z₁, Z₂ and Z₃ shall be ±2 mm for the size of 100 or less and ±3 mm for the size of 125 or more.
2. ● conform to the JPPFA standard. 3. □ conform to the AV standard.

PRODUCT MODEL CODE LIST

Type	Field	Material	Model	Standard	Others	Size
D	N	U	**	U	N	***
⋮	⋮	⋮	⋮	⋮	⋮	⋮
D VU Fitting	N Standard	U U-PVC	DL VU-DL 90° Elbow 4L VU-45L 45° Elbow DS VU-DS Socket DT VU-DT 90°Y	U VU	N Normal Color	200 200 mm 300 300 mm

VU Large Fitting Socket Common Dimensions

This is used for non-pressurized piping such as drainage and sewer piping.

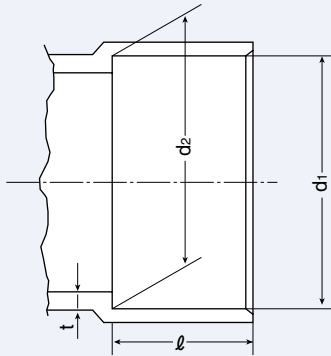

Dimensions Table

(Unit: mm)

Size	d1		d2		l		t
	Basic Dimension	Tolerance	Basic Dimension	Tolerance	Basic Dimension	Tolerance	Min Dimension
200	217.30	-0.55	214.70	±0.55	110	±2	5.5
250	268.55	-0.60	265.45	±0.60	130	±2	6.0
300	319.75	-0.65	316.25	±0.65	150	±2	7.2

Notes: 1. d1 and d2 shall be the average of measured inner diameters of 2 directions or more perpendicular to each other.

AV 90° Elbow

Abbreviation: **VU-DL**

(JPPFA AS12)

PRODUCT MODEL CODE

VU-DL ▶ **D N U DL U N** Size



U-PVC

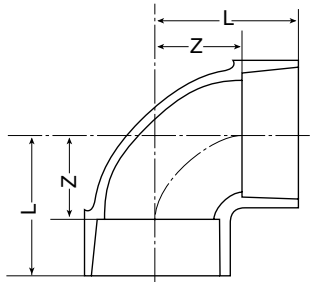

Dimensions Table

(Unit: mm)

Size	Z	L
□ 200	115	225
□ 250	141	271
□ 300	168	318

Notes: 1. □ conform to the AV standard.

AV45° Elbow

Abbreviation: **VU-45L**

(JPPFA AS12)

PRODUCT MODEL CODE

VU-45L ▶ **D N U 4L U N** Size



U-PVC

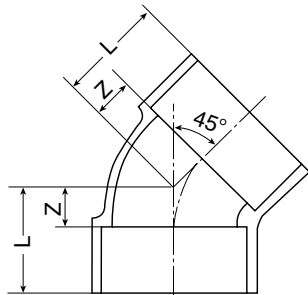

Dimensions Table

(Unit: mm)

Size	Z	L
● 200	56	166
● 250	68	198
● 300	78	228

Notes: 1. ● conform to the JPPFA Standard.

AV Socket

Abbreviation: **VU-DS**

(JPPFA AS12)

PRODUCT
MODEL CODE

VU-DS ▶ D N U DS U N Size

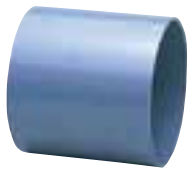

U-PVC

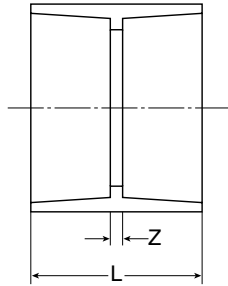

■ Dimensions Table

(Unit: mm)

Size	Z	L
● 200	5	225
● 250	6	266
● 300	7	307

Notes: 1. ● conform to the JPPFA Standard.

AV 90°Y

Abbreviation: **VU-DT**

(JPPFA AS12)

PRODUCT
MODEL CODE

VU-DT ▶ D N U DT U N Size



U-PVC

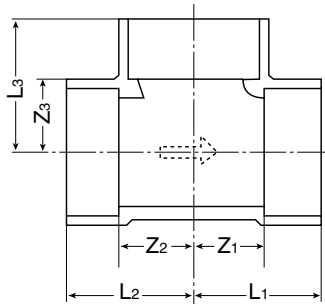

■ Dimensions Table

(Unit: mm)

Size	Z ₁	Z ₂	Z ₃	L ₁	L ₂	L ₃
□ 200	115	116	115	225	226	225
□ 250	141	144	141	271	274	271
□ 300	168	171	168	318	321	318

Notes: 1. An arrow to show direction of flow shall be embossed on the outside as shown in the diagram. 2. □ conform to the AV standard.

PRODUCT MODEL CODE LIST

Model	Material	Rubber	Connection	Standard	Size
JEP	U	*	T	J	***
⋮	⋮	⋮	⋮	⋮	⋮
JEP Expansion Joint	U U-PVC	E EPDM V FKM F Viflon®F/FKM-F C Viflon®C/FKM-C	T Socket	J JIS	020 20 mm I 100 100 mm

Expansion Joint



Features

- Expansion/contraction absorption margin is large and the thermal stress of piping is absorbed.
- Easy removal from piping by just loosening the union nut.
- No need for a large piping space with the compact design.
- No need for installation of piping expansion U bend.
- No slipping of pipes. (Because stop ring ⑤ is provided)

Dimensions Table

(Unit: mm)

Size		d	d ₁	ℓ ₁	1/T	D ₂	D ₁	D ₃	L		ℓ ₂ Expansion/ Contraction Margin
mm	inch								Max.	Min.	
20	3/4	20	26.13	24	1/34	35	60	35	243	163	80
25	1	25	32.16	27	1/34	43	70	39	250	170	80
30	1 1/4	31	38.19	30	1/34	50	82	47	258	178	80
40	1 1/2	40	48.21	37	1/37	59	100	59	272	192	80
50	2	51	60.25	42	1/37	72	106	72	285	205	80
65	2 1/2	65	76.60	61	1/48	88	133	88	314	234	80
75	3	78	89.60	64	1/49	105	152	105	330	250	80
100	4	100	114.70	84	1/56	132	210	132	422	322	100

Parts Table

No.	Description	pcs.	Material
①	Body	1	U-PVC
②	End Connector (A)	1	U-PVC
③	End Connector (B)	1	U-PVC
④a	Union Nut (A)	-	U-PVC
④b	Union Nut (B) ¹⁾	1	U-PVC
⑤	Stop Ring	1	U-PVC
⑥	O-Ring (A)	1	EPDM, FKM, Viflon®F (FKM-F), Viflon®C (FKM-C)
⑦	O-Ring (B)	2	EPDM, FKM, Viflon®F (FKM-F), Viflon®C (FKM-C)

1) Use for 65 to 100 mm.

<Use Precautions>

- Make sure to provide the first support (loose support) at 0.5 m or less of an expansion joint on both sides.
- Sufficiently consider the expansion and contraction amounts of piping. (When piping expands: Use the expansion joint being extended to a certain degree.) (When piping contracts: Use the expansion joint being shrunk to a certain degree.)

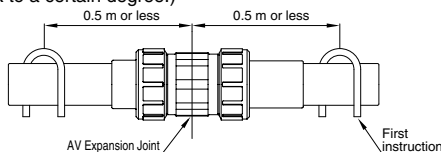

Main Specification

Material	Working Temperature	Maximum Working Pressure (Normal Temperature) MPa(kg/cm ²)	Connection Socket End
Unplasticized Polyvinyl Chloride Pipe (U-PVC)	5-60°C	1.0{10.2}	○

Dimensions Diagram

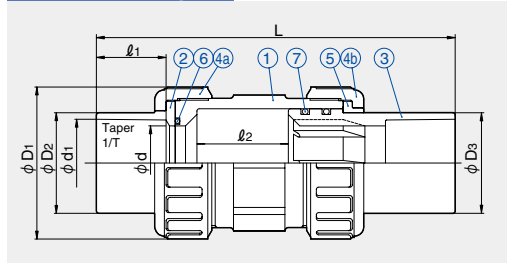

When installing

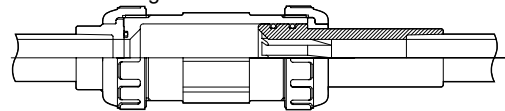

When piping is expanded by heat

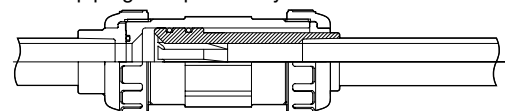

Pipe Heat Expansion Table

(Unit: mm)

Piping Length L Temperature Difference	Piping Length L								
	5m	10m	20m	30m	40m	50m	60m	70m	80m
10°C	4	7	14	21	28	35	42	49	56
20°C	7	14	28	42	56	70	84	98	112
30°C	11	21	42	63	84	105	126	147	168
40°C	14	28	56	84	112	140	168	196	224
50°C	18	35	70	105	140	175	210	245	280
60°C	21	42	84	126	168	210	252	294	336
70°C	25	49	98	147	196	245	294	343	392
80°C	28	56	112	168	224	280	336	392	448

<Example> How often (every XX m) shall expansion joints be inserted when the size is 75 mm and temperature difference is 20°C?

Calculation Formula $L = \frac{\Delta \ell}{\alpha \Delta t} \dots \dots \dots (1)$

- L: Length of piping that the expansion joint absorbs (mm)
- Δℓ: Piping expansion/contraction length Expansion/contraction margin for 75 mm from the dimensions table ℓ₂=80 mm
Give margins on both ends 5 mm×2=10 mm Δℓ:=(80-10) mm
- α: Heat expansion coefficient of hard polyvinyl chloride pipe 7×10⁻⁵ (/°C)
- Δt: Temperature difference 20 (°C)

When the value above is assigned to (1) $L = \frac{80-10}{7 \times 10^{-5} \times 20} = 50000 \text{ mm}$

∴ One piece per 50 m.

PRODUCT MODEL CODE LIST

Model	Material	Rubber	Connection	Standard	Size
JPF	U	*	*	J	***
⋮	⋮	⋮	⋮	⋮	⋮
JPF Prefab Joint	U U-PVC	E EPDM V FKM F Viflon®F/FKM-F C Viflon®C/FKM-C	T Socket N Threaded	J JIS	013 13 mm 100 100 mm

Prefab Joint



Features

- Installation is extremely simple and it can be done quickly and certainly. (Especially necessary for sleeve bonding/screw-in piping)
- Installable on piping where suitable and easy cleaning inside pipes.
- After installing piping, the valve parts can be removed by just loosening the union nut. It is suitable for pipelines requiring regular removals such as temporary piping and slurry piping.

Body Material	Connection Method	13	16	20	25	30	40	50	65	75	100
U-PVC	Socket end	○	○	○	○	○	○	○	○	○	○
	Threaded end	○	○	○	○	○	○	○	—	—	—

Parts Table

No.	Description	pcs.	Material
①	Body	1	U-PVC
②	End Connector	1	U-PVC
③	Union Nut	1	U-PVC
④	O-Ring	1	EPDM, FKM, Viflon®F (FKM-F), Viflon®C (FKM-C)

Main Specification

Material	Made of Unplasticized Polyvinyl Chloride (U-PVC)
Working Temperature	0-50°C
Maximum Working Pressure	1.0MPa{10.2kg/cm ² }

Dimensions Diagram

Socket End (13 – 50 mm)

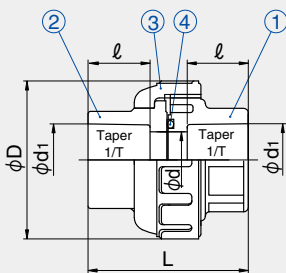

Threaded End (13 – 50 mm)

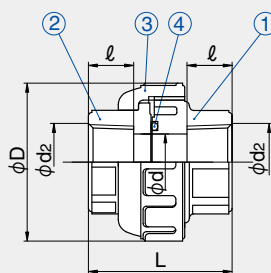

Socket End (65 – 100 mm)

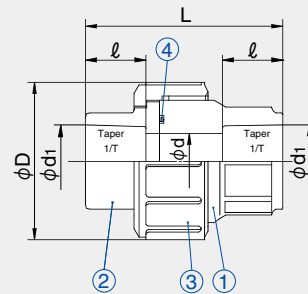

Dimensions Table

(Unit: mm)

Size	d	Socket End				Threaded end			D
		d ₁	ℓ	1/T	L	d ₂	ℓ	L	
13	13	18.13	18	1/30	46	Rc ³ / ₈	15	43	48
16	15	22.11	20	1/34	46	Rc ¹ / ₂	15	43	48
20	20	26.13	24	1/34	61	Rc ³ / ₄	17	57	60
25	25	32.16	27	1/34	70	Rc1	20	63	70
30	31	38.19	30	1/34	77	Rc1 ¹ / ₄	22	71	82
40	40	48.21	37	1/37	95	Rc1 ¹ / ₂	25	82	100
50	51	60.25	42	1/37	107	Rc2	28	96	106
65	65	76.60	61	1/48	164	—	—	—	133
75	77	89.60	64	1/49	189.5	—	—	—	152
100	100	114.70	84	1/56	245	—	—	—	210

PRODUCT MODEL CODE LIST

■ Threaded End TYPE L 20 – 30 mm

Type/Field	Material	Model 1	Model 2	Standard	Size of Special Connection Parts	Size
WM	U	*	*	*	*	***
WM Multi J	U U-PVC	1 Threaded Welding 2 Threaded Bonding	L TYPE L T TYPE T	R RC Threaded End N NPT Threaded End	2 1/4 3 3/8	020 20 mm I 030 30 mm

■ Threaded End TYPE L 40 – 200 mm

Type/Field	Material	Model 1	Model 2	Standard	Size of Special Connection Parts	Size
WM	U	*	L	*	*	***
WM Multi J	U U-PVC	N Threaded Cast Product 2 Threaded Bonding 4 Bonding FRP Reinforcement	L TYPE L	R RC Threaded End N NPT Threaded End	2 1/4 3 3/8 4 1/2 6 3/4	040 40 mm I 150 150 mm 200 200 mm

200 mm is processed product.

■ Threaded End TYPE T 20 – 30 mm

Type/Field	Material	Model 1	Model 2	Standard	Size of Special Connection Parts	Size
WM	U	*	*	*	*	***
WM Multi J	U U-PVC	1 Threaded Welding 2 Threaded Bonding	L TYPE L T TYPE T	R RC Threaded End N NPT Threaded End	2 1/4 3 3/8	020 20 mm I 030 30 mm

■ Threaded End TYPE T 40 – 200 mm

Type/Field	Material	Model 1	Model 2	Standard	Size of Special Connection Parts	Size
WM	U	*	T	*	*	***
WM Multi J	U U-PVC	1 Welding 2 Threaded Bonding 3 Welding FRP Reinforcement 4 Bonding FRP Reinforcement	T TYPE T	R RC Threaded End N NPT Threaded End	2 1/4 3 3/8 4 1/2 6 3/4	040 40 mm I 200 200 mm

Welding FRP reinforcement and bonding reinforcement are only available with 200 mm.

■ TS-Style TYPE L TYPE T 40 – 200 mm

Type/Field	Material	Model 1	Model 2	Standard	Size of Special Connection Parts	Size
WM	U	*	*	T	*	***
WM Multi J	U U-PVC	1 Welding 2 Bonding 3 Welding FRP Reinforcement 4 Bonding FRP Reinforcement	T TYPE T L TYPE L	T TS-Style	A 016 B 020 C 025 D 040 E 050 F 065 G 075 H 100 I 125	040 40 mm I 200 200 mm

Welding FRP reinforcement and bonding reinforcement are only available with 200 mm.

Multi-Joint

Main Specification

Material	Made of Unplasticized Polyvinyl Chloride (U-PVC)
Working Temperature	0-50°C

Use Example



Installation of various sensors such as pressure gauge and thermometer.



Installation of valves and cocks for sampling and draining.



Compact pipeline with reduced diameter.

Multi-Joint, TYPE L, Threaded-End Style

PRODUCT MODEL CODE WM U N L R Special Fitting Size Size



20 – 30, 200 mm

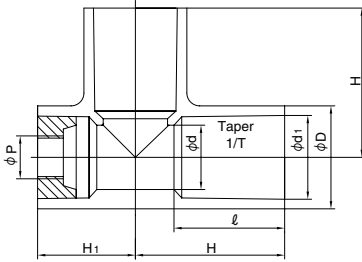

40 – 150mm

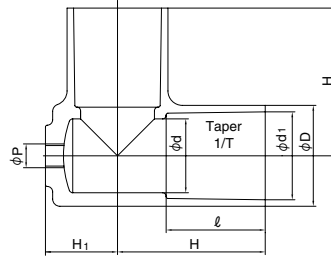

Maximum Working Pressure (20°C)	
20 – 150mm	1.0MPa
200mm	0.6MPa

Combination Table

Threaded End	P							
	Rc				NPT			
Size (mm)	1/4	3/8	1/2	3/4	1/4	3/8	1/2	3/4
20	○	○	—	—	○	○	—	—
25	○	○	—	—	○	○	—	—
30	○	○	—	—	○	○	—	—
40	○	○	○	○	○	○	○	○
50	○	○	○	○	○	○	○	○
65	○	○	○	○	○	○	○	○

Threaded End	P							
	Rc				NPT			
Size (mm)	1/4	3/8	1/2	3/4	1/4	3/8	1/2	3/4
75	○	○	○	○	○	○	○	○
100	○	○	○	○	○	○	○	○
125	○	○	○	○	○	○	○	○
150	○	○	○	○	○	○	○	○
200	○	○	○	○	○	○	○	○

Notes: U-PVC (Gray) is not casted product so that the shape varies.

Dimensions Table

Size	d	d1	l	1/T	D	H	H1
20	20	26.45	35	1/34	33	50	32
25	25	32.55	40	1/34	40	58	38
30	31	38.60	44	1/34	46	65	43
40	40	48.70	55	1/37	57	82	40
50	51	60.80	63	1/37	70	96	52
65	67	76.60	61	1/48	87	110	68

(Unit: mm)

Size	d	d1	l	1/T	D	H	H1
75	77	89.60	64	1/49	102	120	74
100	100	114.70	84	1/56	130	152	98
125	125	140.85	104	1/58	157	187	126.5
150	146	166.00	132	1/63	186	230	151.5
200	196	217.00	145	1/50	240	266	193

Multi-Joint, TYPE T, Threaded-End Style

PRODUCT MODEL CODE WM U Model 1 T Standard Special Fitting Size Size

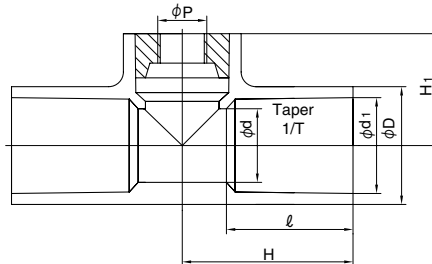

Maximum Working Pressure (20°C)	
20 – 150mm	1.0MPa
200mm	0.6MPa

Combination Table

Threaded End	P							
	Rc				NPT			
Size (mm)	1/4	3/8	1/2	3/4	1/4	3/8	1/2	3/4
20	○	○	—	—	○	○	—	—
25	○	○	—	—	○	○	—	—
30	○	○	—	—	○	○	—	—
40	○	○	○	○	○	○	○	○
50	○	○	○	○	○	○	○	○
65	○	○	○	○	○	○	○	○

Threaded End	P							
	Rc				NPT			
Size (mm)	1/4	3/8	1/2	3/4	1/4	3/8	1/2	3/4
75	○	○	○	○	○	○	○	○
100	○	○	○	○	○	○	○	○
125	○	○	○	○	○	○	○	○
150	○	○	○	○	○	○	○	○
200	○	○	○	○	○	○	○	○

Dimensions Table

Size	d	d1	l	1/T	D	H	H1
20	20	26.45	35	1/34	33	50	32
25	25	32.55	40	1/34	40	58	38
30	31	38.6	44	1/34	46	65	43
40	40	48.7	55	1/37	57	82	55
50	51	60.8	63	1/37	70	90	61
65	67	76.6	61	1/48	87	100	68

(Unit: mm)

Size	d	d1	l	1/T	D	H	H1
75	77	89.6	64	1/49	102	100	75
100	100	114.7	84	1/56	130	140	100
125	125	140.85	104	1/58	157	160	115
150	146	166	132	1/63	186	195	126
200	196	217	145	1/50	240	201	148

Multi-Joint, TYPE L, TS-Style

PRODUCT MODEL CODE WM U Model 1 L T Special Fitting Size Size

Maximum Working Pressure (20°C)
 20 – 150 mm 1.0MPa
 200mm 0.6MPa

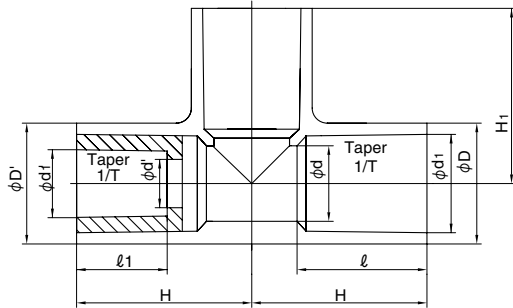

Combination Table

Size (mm)	Model	16	20	25	40	50	65	75	100	125
40	TYPE L	☆	☆	☆						
	TYPE T	☆	★	★						
50	TYPE L	☆	☆	☆						
	TYPE T	★	★	★						
65	TYPE L	☆	☆	☆	☆					
	TYPE T	☆	☆	☆	★					
75	TYPE L	☆	☆	☆	☆	☆				
	TYPE T	☆	☆	★	★	★				
100	TYPE L	☆	☆	☆	☆	☆	☆			
	TYPE T	☆	☆	☆	☆	★	☆			
125	TYPE L	☆	☆	☆	☆	☆	☆	☆		
	TYPE T	☆	☆	☆	☆	☆	☆	★		
150	TYPE L	☆	☆	☆	☆	☆	☆	☆	☆	
	TYPE T	☆	☆	☆	☆	☆	☆	★	★	
200	TYPE L	☆	☆	☆	☆	☆	☆	☆	☆	☆
	TYPE T	☆	☆	☆	☆	☆	☆	★	★	☆

Notes: ★ can be handled with TS fitting.

Dimensions Table

(Unit: mm)

Size	d	d1	ℓ	1/T	D	d'	d1'	ℓ'	1/T1	D'	H	H1
40× 16	40	48.70	55	1/37	57	16	22.40	30	1/34	57	82	82
40× 20	40	48.70	55	1/37	57	20	26.45	35	1/34	57	82	82
40× 25	40	48.70	55	1/37	57	25	32.55	40	1/34	57	82	82
50× 16	51	60.80	63	1/37	70	16	22.40	30	1/34	70	96	96
50× 20	51	60.80	63	1/37	70	20	26.45	35	1/34	70	96	96
50× 25	51	60.80	63	1/37	70	25	32.55	40	1/34	70	96	96
65× 16	67	76.60	61	1/48	87	16	22.40	30	1/34	87	110	110
65× 20	67	76.60	61	1/48	87	20	26.45	35	1/34	87	110	110
65× 25	67	76.60	61	1/48	87	25	32.55	40	1/34	87	110	110
65× 40	67	76.60	61	1/48	87	40	48.70	55	1/37	87	110	110
75× 16	77	89.60	64	1/49	102	16	22.40	30	1/34	102	120	120
75× 20	77	89.60	64	1/49	102	20	26.45	35	1/34	102	120	120
75× 25	77	89.60	64	1/49	102	25	32.55	40	1/34	102	120	120
75× 40	77	89.60	64	1/49	102	40	48.70	55	1/37	102	120	120
75× 50	77	89.60	64	1/49	102	51	60.80	63	1/37	102	120	120
100× 16	100	114.70	84	1/56	130	16	22.40	30	1/34	130	152	152
100× 20	100	114.70	84	1/56	130	20	26.45	35	1/34	130	152	152
100× 25	100	114.70	84	1/56	130	25	32.55	40	1/34	130	152	152
100× 40	100	114.70	84	1/56	130	40	48.70	55	1/37	130	152	152
100× 50	100	114.70	84	1/56	130	51	60.80	63	1/37	130	152	152
100× 65	100	114.70	84	1/56	130	67	76.60	61	1/48	130	152	152
125× 16	125	140.85	104	1/58	157	16	22.40	30	1/34	157	187	187
125× 20	125	140.85	104	1/58	157	20	26.45	35	1/34	157	187	187
125× 25	125	140.85	104	1/58	157	25	32.55	40	1/34	157	187	187
125× 40	125	140.85	104	1/58	157	40	48.70	55	1/37	157	187	187
125× 50	125	140.85	104	1/58	157	51	60.80	63	1/37	157	187	187
125× 65	125	140.85	104	1/58	157	67	76.60	61	1/48	157	187	187
125× 75	125	140.85	104	1/58	157	77	89.60	64	1/49	157	187	187
150× 16	146	166.00	132	1/63	186	16	22.40	30	1/34	186	230	230
150× 20	146	166.00	132	1/63	186	20	26.45	35	1/34	186	230	230
150× 25	146	166.00	132	1/63	186	25	32.55	40	1/34	186	230	230
150× 40	146	166.00	132	1/63	186	40	48.70	55	1/37	186	230	230
150× 50	146	166.00	132	1/63	186	51	60.80	63	1/37	186	230	230
150× 65	146	166.00	132	1/63	186	67	76.60	61	1/48	186	230	230
150× 75	146	166.00	132	1/63	186	77	89.60	64	1/49	186	230	230
150×100	146	166.00	132	1/63	186	100	114.70	84	1/56	186	230	230
200× 16	196	217.00	145	1/50	240	16	22.40	30	1/34	240	266	266
200× 20	196	217.00	145	1/50	240	20	26.45	35	1/34	240	266	266
200× 25	196	217.00	145	1/50	240	25	32.55	40	1/34	240	266	266
200× 40	196	217.00	145	1/50	240	40	48.70	55	1/37	240	266	266
200× 50	196	217.00	145	1/50	240	51	60.80	63	1/37	240	266	266
200× 65	196	217.00	145	1/50	240	67	76.60	61	1/48	240	266	266
200× 75	196	217.00	145	1/50	240	77	89.60	64	1/49	240	266	266
200×100	196	217.00	145	1/50	240	100	114.70	84	1/56	240	266	266
200×125	196	217.00	145	1/50	240	125	140.85	104	1/58	240	266	266

Multi-Joint, TYPE T, TS-Style

PRODUCT MODEL CODE WM U Model 1 T T Special Fitting Size Size

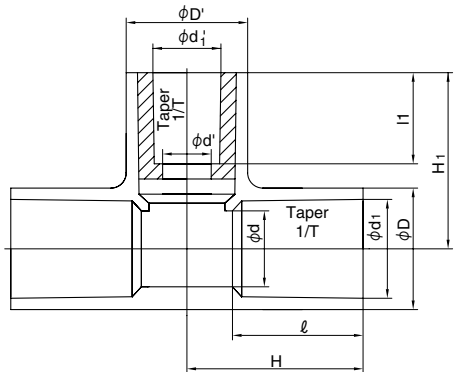

Maximum Working Pressure (20°C)
 20 – 150mm 1.0MPa
 200mm 0.6MPa

Combination Table

Size (mm)	Model	16	20	25	40	50	65	75	100	125
40	TYPE L	☆	☆	☆						
	TYPE T	☆	★	★						
50	TYPE L	☆	☆	☆						
	TYPE T	★	★	★						
65	TYPE L	☆	☆	☆	☆					
	TYPE T	☆	☆	☆	★					
75	TYPE L	☆	☆	☆	☆	☆				
	TYPE T	☆	☆	★	★	★				
100	TYPE L	☆	☆	☆	☆	☆	☆			
	TYPE T	☆	☆	☆	☆	★	☆			
125	TYPE L	☆	☆	☆	☆	☆	☆	☆		
	TYPE T	☆	☆	☆	☆	☆	☆	★		
150	TYPE L	☆	☆	☆	☆	☆	☆	☆	☆	
	TYPE T	☆	☆	☆	☆	☆	☆	★	★	
200	TYPE L	☆	☆	☆	☆	☆	☆	☆	☆	☆
	TYPE T	☆	☆	☆	☆	☆	☆	★	★	☆

Notes: ★ can be handled with TS fitting.

Dimensions Table

(Unit: mm)

Size	d	d1	l	1/T	D	d'	d1'	l'	1/T1	D'	H	H1
40x 16	40	48.70	55	1/37	57	16	22.40	30	1/34	57	82	82
65x 16	67	76.60	61	1/48	87	16	22.40	30	1/34	57	95	95
65x 20	67	76.60	61	1/48	87	20	26.45	35	1/34	57	95	95
65x 25	67	76.60	61	1/48	87	25	32.55	40	1/34	57	95	95
75x 16	77	89.60	64	1/49	102	16	22.40	30	1/34	57	100	102
75x 20	77	89.60	64	1/49	102	20	26.45	35	1/34	57	100	102
100x 16	100	114.70	84	1/56	130	16	22.40	30	1/34	70	125	122
100x 20	100	114.70	84	1/56	130	20	26.45	35	1/34	70	125	122
100x 25	100	114.70	84	1/56	130	25	32.55	40	1/34	70	125	122
100x 40	100	114.70	84	1/56	130	40	48.70	55	1/37	102	140	132
100x 65	100	114.70	84	1/56	130	67	76.60	61	1/48	130	152	152
125x 16	125	140.85	104	1/58	157	16	22.40	30	1/34	102	161	147
125x 20	125	140.85	104	1/58	157	20	26.45	35	1/34	102	161	147
125x 25	125	140.85	104	1/58	157	25	32.55	40	1/34	102	161	147
125x 40	125	140.85	104	1/58	157	40	48.70	55	1/37	102	161	147
125x 50	125	140.85	104	1/58	157	51	60.80	63	1/37	102	161	147
125x 65	125	140.85	104	1/58	157	67	76.60	61	1/48	130	175	167
150x 16	146	166.00	132	1/63	186	16	22.40	30	1/34	102	195	158
150x 20	146	166.00	132	1/63	186	20	26.45	35	1/34	102	195	158
150x 25	146	166.00	132	1/63	186	25	32.55	40	1/34	102	195	158
150x 40	146	166.00	132	1/63	186	40	48.70	55	1/37	102	195	158
150x 50	146	166.00	132	1/63	186	51	60.80	63	1/37	102	195	158
150x 65	146	166.00	132	1/63	186	67	76.60	61	1/48	130	208	182
200x 16	194	217.00	145	1/50	240	16	22.40	30	1/34	102	201	180
200x 20	194	217.00	145	1/50	240	20	26.45	35	1/34	102	201	180
200x 25	194	217.00	145	1/50	240	25	32.55	40	1/34	102	201	180
200x 40	194	217.00	145	1/50	240	40	48.70	55	1/37	102	201	180
200x 50	194	217.00	145	1/50	240	51	60.80	63	1/37	102	201	180
200x 65	194	217.00	145	1/50	240	67	76.60	61	1/48	130	215	200
200x125	194	217.00	145	1/50	240	125	140.85	104	1/58	240	266	266

Technical Data

1. General Properties

U-PVC (General)
at:23°C

Characteristics	Standard Value	Value	Unit
Specific Gravity	1.40 – 1.45	1.43	-
Water Absorption (24 hr)	0.07 – 0.2	0.07 – 0.1	%
Tensile Yield Stress	45 or more	48 – 62	MPa
Extension Ratio	-	80 or more	%
Impact Value (Izod)	-	3 – 5	kJ/m ²
Compression Strength	83 or more	90	MPa
Bending Strength	98 or more	108	MPa
Rockwell Hardness (R scale)	114 – 116	115	-
Linear Expansion Coefficient	6 – 8	7	10 ⁻⁵ /°C
Heat Deformation Temperature	70 or more	75	°C
Flame Resistance	-	Self-Extinguishing	-
Permittivity	2.8 – 3.1	2.8 – 3.0	10 ⁶ cycles
Sunlight Resistance	-	Favorable	-

U-PVC (For tap water)
at:23°C

Characteristics	Standard Value	Value	Unit
Specific Gravity	1.40 – 1.45	1.43	-
Water Absorption (24 hr)	0.07 – 0.2	0.07 – 0.1	%
Tensile Yield Stress	45 or more	54 – 56	MPa
Extension Ratio	-	80 or more	%
Impact Value (Izod)	-	3 – 4	kJ/m ²
Compression Strength	83 or more	88	MPa
Bending Strength	98 or more	103	MPa
Rockwell Hardness (R scale)	114 – 116	115	-
Linear Expansion Coefficient	6 – 8	7	10 ⁻⁵ /°C
Heat Deformation Temp.	70 or more	73	°C
Flame Resistance	-	Self-Extinguishing	-
Permittivity	2.8 – 3.1	2.8 – 3.0	10 ⁶ cycles
Sunlight Resistance	-	Favorable	-

HI-PVC
at:23°C

Characteristics	Standard Value	Value	Unit
Specific Gravity	1.40 – 1.45	1.43	-
Tensile Yield Stress	40 or more	40 – 56	MPa
Extension Ratio	80 or more	80 or more	%
Impact Value (Charpy)	18 or more	19 – 24	kJ/m ²
Compression Strength	59 or more	59 – 78	MPa
Bending Strength	78 or more	78 – 88	MPa
Rockwell Hardness (R scale)	112 – 116	114	-
Linear Expansion Coefficient	7 – 8	7 – 8	10 ⁻⁵ /°C
Vicat Softening Temperature Test	76 or more	80 – 82	°C
Flame Resistance	-	Self-Extinguishing	-
Sunlight Resistance	-	Favorable	-

2. Short-Term Strength Test

Tensile Strength and Temperature Dependency

Relationship of Tensile Strength and Temperature between U-PVC and Other Plastics

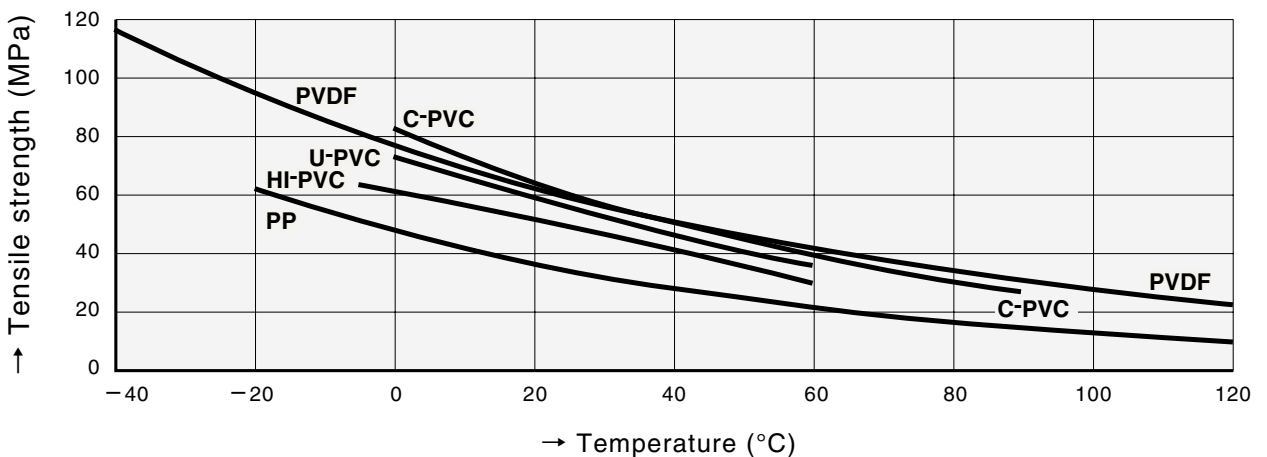

Notes: Tension speed.....10 mm/min

3. Short-Term Burst Pressure Test

a. Genera Pipe (VP) JIS K 6741-1995 Temperature Condition: 20°C

Size (mm)	Short-Term Burst Pressure MPa {kgf/cm ² }	Maximum Working Pressure* MPa {kgf/cm ² }
13	13.1 { 133.6}	1.0 { 10.2}
16	13.2 { 134.2}	1.0 { 10.2}
20	10.9 { 111.2}	1.0 { 10.2}
25	10.1 { 102.9}	1.0 { 10.2}
30	8.3 { 85.2}	1.0 { 10.2}
40	7.6 { 77.8}	1.0 { 10.2}
50	6.9 { 70.4}	1.0 { 10.2}
65	5.4 { 54.7}	1.0 { 10.2}
75	6.2 { 63.2}	1.0 { 10.2}
100	5.8 { 58.9}	1.0 { 10.2}
125	4.9 { 50.5}	1.0 { 10.2}
150	5.4 { 54.7}	1.0 { 10.2}
200	4.7 { 48.0}	1.0 { 10.2}
250	4.7 { 47.9}	1.0 { 10.2}
300	4.7 { 47.8}	1.0 { 10.2}

b. Genera Pipe (VU) JIS K-6741-1995 Temperature Condition: 20°C

Size (mm)	Short-Term Burst Pressure MPa {kgf/cm ² }	Maximum Working Pressure* MPa {kgf/cm ² }
40	3.7 {37.4}	0.6 {6.1}
50	2.9 {29.7}	0.6 {6.1}
65	2.8 {28.6}	0.6 {6.1}
75	2.9 {30.0}	0.6 {6.1}
100	2.6 {26.8}	0.6 {6.1}
125	2.8 {28.9}	0.6 {6.1}
150	3.0 {30.6}	0.6 {6.1}
200	2.9 {29.8}	0.6 {6.1}
250	2.8 {28.9}	0.6 {6.1}
300	2.8 {28.6}	0.6 {6.1}
350	2.7 {28.0}	0.6 {6.1}
400	2.7 {27.7}	0.6 {6.1}
450	2.7 {27.7}	0.6 {6.1}
500	2.7 {27.7}	0.6 {6.1}

Notes: 1. Burst pressure value is calculated with the tensile strength specified in the quality section of JIS K 6741 (minimum value 47 N/mm² {480kgf/cm²} at 20°C during test). Therefore, this value is the minimum value and the actual value would be much higher.

2. Short-term burst pressure will be derived from the following Naday formula.

$$P = \frac{2 \times \sigma}{(D/t-1)}$$

P : Working pressure (MPa) {kgf/cm²}
 σ : Design stress (N/mm²) {kgf/cm²}
 D : Outer diameter (mm)
 t : Thickness (mm)

3. For general pressure-transporting pipes, pipes with different sizes are often used in a single conduit. Therefore, the maximum working pressure would be 1.0 MPa {10.2kgf/cm²} for VP, 0.6MPa {6.1kgf/cm²} for VU and 0.8 MPa {8.2kgf/cm²} for VM.

c. Genera Pipe (VM) JIS K6741 Temperature Condition: 20°C

Size (mm)	Short-Term Burst Pressure MPa {kgf/cm ² }	Maximum Working Pressure MPa {kgf/cm ² }
350	3.8 { 38.6}	0.8 { 8.2}

Notes: Maximum Working Pressure is the pressure including the water hammer pressure.
 Do not use them exceeding the maximum working pressure.

4. Relationship between Maximum Working Pressure and Temperature

Unplasticized Polyvinyl Chloride Pipe

VP Unit: MPa {kgf/cm²}

Size (mm)	Temperature				
	0 to 20°C	Up to 30°C	Up to 40°C	Up to 50°C	Up to 60°C
13 to 300	1.0 {10.2}	0.9 {9.2}	0.7 {7.1}	0.3 {3.1}	0.1 {1.0}

VU Unit: MPa {kgf/cm²}

Size (mm)	Temperature				
	0 to 20°C	Up to 30°C	Up to 40°C	Up to 50°C	Up to 60°C
40 to 500	0.6 {6.1}	0.5 {5.1}	0.4 {4.1}	0.2 {2.0}	0.06 {0.6}

Notes: Maximum Working Pressure is the pressure including the water hammer pressure. Do not use them exceeding the maximum working pressure.

Installation of TS Connection



1 Pipe Cutting

Use wide thick paper or tape for the pipe cutting area, put a cutting gauge line with a permanent marker on the entire circumference, and cut perpendicular to the pipe shaft.



2 Chamfer

Lightly chamfer the entire inner/outer perimeters using a tool such as file or chamfer. When a pipe is cut, especially, finish the pipe end surface without burrs and warping.

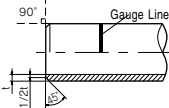

Notes: Not properly performing chamfering could cause installation failure so please make sure to chamfer.



3 Entry of Gauge Line

For the pipe insertion gauge line of the sizes 13 to 40 mm, measure the fitting socket length ℓ from the pipe end and mark on the pipe body with a marker. For the pipe insertion gauge line for the sizes 50 to 150 mm, it shall be at a position of the zero point plus the bonding margin length in Table 2. Mark the gauge line on the pipe body with a permanent marker.

Table 1. TS Fitting Socket Normal Length Unit: mm

Size	13	16	20	25	30	40	50	65	75	100	125	150
Fitting Socket Length	26	30	35	40	44	55	63	61	64	84	104	132

[Reference] Table 2. Bonding Margin Length Unit: mm

Size	13	16	20	25	30	40	50	65	75	100	125	150
Bonding Margin Length	10	10	15	15	15	20	20	20	25	30	35	45

* Refer to [Explanation] 2.



4 Rinsing

Wipe and clean the inner face of fitting socket and the outer face of pipe insertion port with a cloth. In particular, when oil or water in the connection part, clean by using a small amount of acetone and alcohol.

Notes: Not properly performing rinsing could cause installation failure so please make sure to rinse.



5 Adhesive Application

Use a special adhesive compatible to the type of pipe and apply it evenly in the order of on the inner face of fitting and the outer face of pipe. In particular, apply thinly and evenly to the inner face of fitting. The reference ratio of adhesive application is 7 to 3 for pipe and fitting.

Table 3. Usage of Adhesive per Connection Part (Reference)

Size (mm)	13	16 (15)	20	25	30 (32)	40	50	65	75	100	125	150
Usage (g)	0.9	1.2	1.7	2.0	3.1	5.0	7.1	9.9	12	20	30	44

* Refer to [Explanation] 4.



6 Insertion

After applying adhesive, insert pipe into fitting straight without turning the pipe immediately at once and press it in that condition. Refer to Table 4 for this normal press time.

Table 4. Normal Press Time of TS Connection

Size (mm)	50 or less	65 or more
Normal Press Time (Sec.)	30 or more	60 or more

* Use an inserter for large diameters.

Notes: Due to the relationship of pipe and fitting dimension tolerance, it may not be inserted all the way to the end. In this case, do not insert it forcibly by hammering and such. Inserting forcibly may place a large burden on the fitting and cause damage.



7 Adhesive Treatment

After connection, wipe the protruded adhesive immediately and do not apply forcible stress on the connection part.



8 Removal of Solvent Content

Adhesive contains organic solvent, and the solvent steam needs to be removed after connection. During curing after piping, open both ends of pipe without enclosing and remove the solvent steam. During curing, the steam can be removed more effectively by ventilating inside piping using a ventilator (low-pressure specification) or washing inside piping by filling the water after the adhesive is hardened.

* Refer to [Explanation] 4.

[Explanation]

1 TS connection utilizes the swelling and elasticity of PVC by making the fitting socket tapered and using adhesive. Applying adhesive to the pipe and fitting would create a swelling layer of approximately 0.1 mm thickness on its surface as shown (Figure 1), and this layer makes the insertion of the pipe fluidly. After insertion, respective swelling layers of the pipe and fitting would interact each other, and the bonding surface would be unified.

Figure 1. Installation of TS Connection

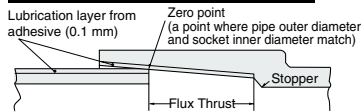
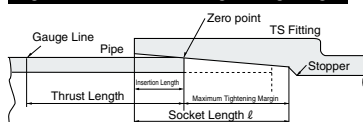

Figure 2. Zero Point and Tightening Margin



2 Based on a result of testing the relationship between the bonding margin length and pressure-resistant strength, it has been confirmed that practically acceptable water pressure strength can be secured by inserting approximately 1/3 of the fitting socket [ℓ] in addition to the insertion length without applying adhesive (zero point).

In regards to insertion margin in TS connection, it is ideal to insert TS fitting to the length of TS fitting gasket (stopper), but considering the tolerance of pipe and fitting dimensions, the length from zero point plus the bonding margin length shown in Table 2 to the stopper in Table 1 is sufficient enough, and inserting to the stopper of the fitting is not necessarily required.

However, if it cannot be inserted due to the adhesive being dried, etc., cut the connection part and reconnect again by using a new socket.

3 Inserting the pipe into the fitting before applying adhesive is to check the zero point. In this case, a combination of pipe and fitting that provide the insertion length of 1/3 to 2/3 ℓ from the pipe end surface (refer to Figure 2) is standard.

4 Be cautious of excessive adhesive (it may cause solvent cracking and damage). Caution is needed in low-temperature installation because solvent steam does not evaporate easily and tends to remain (it may cause solvent cracking and damage). During curing after piping, open both ends of pipe without enclosing and remove the solvent steam. During curing, the steam can be removed more effectively by ventilating inside piping using a ventilator (low-pressure specification) or washing inside piping by filling the water fully after the adhesive is hardened.

Installation of Rubber Ring Connection



1 Pipe Cutting
Wrap marking tape perpendicular to the pipe shaft, put a cutting section surface on the entire circumference with a permanent marker and cut using a manual saw by avoiding misalignment.



2 Chamfering of Insertion Port
Chamfer the end surface of insertion port with a file, etc.

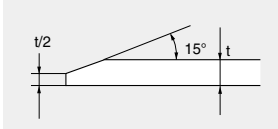

The diagram shows a cross-section of a pipe with a chamfered end. The chamfer angle is 15 degrees. The thickness of the pipe is labeled as 't', and the chamfered portion is labeled as 't/2'.



3 Entry of Gauge Line (Insertion Length)
Mark a gauge line on the insertion port pipe.

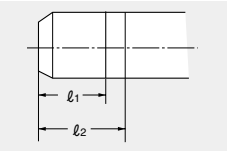

The diagram shows a cross-section of a pipe with two gauge lines, labeled l_1 and l_2 .

Size	l_1	l_2
50	94	107
75	107	120
100	119	132
125	125	138
150	139	152



4 Cleaning of Socket Inner Face
Wipe off the soil and sand attached on the rubber ring and groove and the socket inner face with a cloth.



5 Rubber Ring Installation Method
If the rubber ring is removed for cleaning, put it into the groove by squeezing into a heart shape. Check for twisting and misalignment.



6 Cleaning of Insertion Outer Face
Wipe off the soil and sand attached on the insertion port outer side with a cloth.



7 AV Lubricant Application
Apply AV lubricant to inner face of rubber ring and insertion port (especially the chamfered tip area) evenly. (Never use oil, grease, soap, etc.)

Normal Application Amount		g/location				
Size (mm)	50	75	100	125	150	
Application Amount	4	5	10	15	20	



8 Connection
Insert to between 2 gauge lines. Make sure to avoid the shaft center misalignment and never hammer in by using a hammer.



9 Insertion Depth Check
After connection, check the entire circumference using a check gauge to see if the rubber ring is in a proper condition.

Piping Precautions

- Do not throw around when loading/unloading. Be cautious especially in Winter.
- Store away from direct sunlight and avoid unevenness on the pipe platform. Do not use a transparent sheet because it has no effect and gives a negative influence.
- Do not hammer in when connecting pipes.
- For rubber ring connection, make sure to check the rubber fitting and inspect for twisting and direction. Be cautious of attachment of soil/sand, muddy water, etc.
- Do not clean the rubber ring groove with a slippery item such as lubricant.
- If you notice spring water before backfilling, drain, put sand in a couple of layers and tamper sufficiently.
- Sufficiently fill the area around pipes to avoid any cavity.
- The groove bottom shall be sand, in principle. For weak ground, additionally lay crushed stones underneath or improve the soil quality. Do not have stones and bedrock hit pipes directly.
- Follow the procedure below in the diagram for backfilling.

<Example> In the case of the size 100

Notes: 1. Dotted line shows the position immediately after inserting soil and sand.

Notes: 2. Solid line shows the position after tamping the soil and sand.

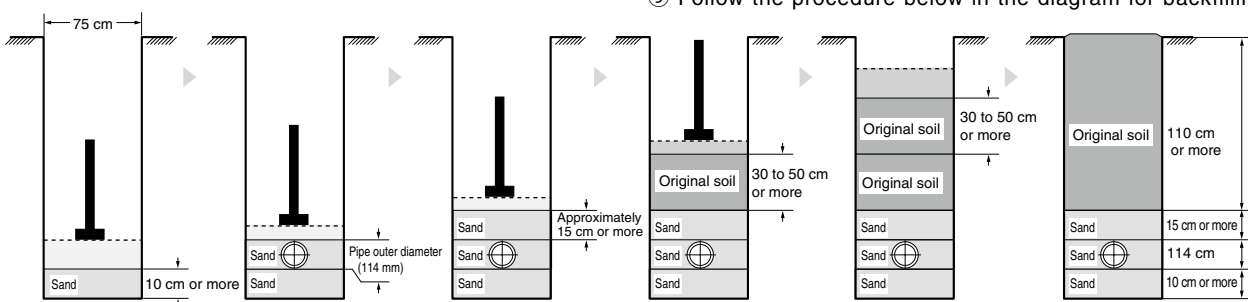

TS Fitting

Elbow [L]

Size (mm)	Packing: pcs.
13	170 / 680
16	100 / 400
20	60 / 240
25	35 / 140
30	25 / 100
40	30 / 60
50	15 / 30
65	20
75	15
100	7
125	5
150	3

45° Elbow [45L]

Size (mm)	Packing: pcs.
20	65 / 260
25	40 / 160

Tee [T]

Size (mm)	Packing: pcs.
13	110 / 440
16	60 / 240
20	40 / 160
25	20 / 80
30	15 / 60
40	15 / 30
50	10 / 20
65	14
75	10
100	4
125	3
150	2
16x13	80 / 320
20x13	50 / 200
20x16	50 / 200
25x13	35 / 140
25x16	30 / 120
25x20	25 / 100
30x13	25 / 100
30x16	20 / 80
30x20	20 / 80
30x25	18 / 72
40x13	30 / 60
40x16	28 / 56
40x20	25 / 50
40x25	23 / 46
40x30	23 / 46
50x13	20 / 40
50x16	20 / 40
50x20	17 / 34
50x25	15 / 30
50x30	13 / 26
50x40	11 / 22

65x 40	18
65x 50	18
75x 25	18
75x 40	14
75x 50	12
75x 65	10
100x 50	6
100x 75	5
125x 75	4
125x100	3
150x 75	3
150x100	2
150x125	2

Faucet Elbow [FL]

Size (mm)	Packing: pcs.
13	150 / 600
16	110 / 440
20	70 / 280
25	40 / 160

Metal-Containing Faucet Elbow [KFL]

Size (mm)	Packing: pcs.
13	150 / 300
16	100 / 200
20	60 / 120
25	35 / 70
20x13	80 / 160

Faucet Socket [FS]

Size (mm)	Packing: pcs.
13	200 / 800
16	150 / 600
20	90 / 360
25	50 / 200

Metal-Containing Faucet Socket [KFS]

Size (mm)	Packing: pcs.
13	170 / 340
16	130 / 260
20	90 / 180
25	45 / 90
20x13	90 / 180

Faucet Tee [FT]

Size (mm)	Packing: pcs.
13	100 / 400
20	40 / 160
25	20 / 80
16x13	65 / 260
20x13	50 / 200
25x13	30 / 120
25x20	25 / 100

Metal-Containing Faucet Tee [KFT]

Size (mm)	Packing: pcs.
20	40 / 80
25	20 / 40
20x13	50 / 100
25x13	35 / 70
25x20	30 / 60

Valve Socket [VS]

Size (mm)	Packing: pcs.
10	400 / 1,600
13	250 / 1,000
16	180 / 720
20	110 / 440
25	60 / 240
30	40 / 160
40	50 / 100
50	30 / 60
65	60
75	36
100	18
125	12
150	4

Union Socket [US]

Size (mm)	Packing: pcs.
13	225 / 900
16	150 / 600
20	100 / 400
25	60 / 240
30	40 / 160
40	50 / 100
50	25 / 50

Socket [S]

Size (mm)	Packing: pcs.
13	210 / 840
16	130 / 520
20	85 / 340
25	50 / 200
30	35 / 140
40	40 / 80
50	24 / 48
65	30
75	22
100	10
125	8
150	4
16x13	160 / 640
20x13	120 / 480
20x16	100 / 400
25x13	70 / 280
25x16	65 / 260
25x20	60 / 240
30x20	40 / 160

30x 25	40 / 160
40x 20	50 / 100
40x 25	50 / 100
40x 30	45 / 90
50x 20	40 / 80
50x 25	25 / 50
50x 30	25 / 50
50x 40	25 / 50
65x 40	40
65x 50	40
75x 40	30
75x 50	30
75x 65	30
100x 75	15
125x100	12
150x100	4
150x125	4

Cap [C]

Size (mm)	Packing: pcs.
13	420 / 1,680
16	250 / 1,000
20	170 / 680
25	100 / 400
30	70 / 280
40	80 / 160
50	40 / 80
65	60
75	36
100	18
150	6

Metal-Containing Valve Socket [KVS]

Size (mm)	Packing: pcs.
13	100 / 200

HITS Fitting

Elbow [L]

Size (mm)	Packing: pcs.
13	170 / 680
16	100 / 400
20	60 / 240
25	35 / 140
30	25 / 100
40	30 / 60
50	15 / 30
65	20
75	15
100	7
125	5
150	3

45° Elbow [45L]

Size (mm)	Packing: pcs.
20	65 / 260
25	40 / 160

Tee [T]

Size (mm)	Packing: pcs.
13	110 / 440
16	60 / 240
20	40 / 160
25	20 / 80
30	15 / 60
40	15 / 30
50	10 / 20
65	14
75	10
100	4
125	3
150	2
16x13	80 / 320
20x13	50 / 200
20x16	50 / 200
25x13	35 / 140
25x16	30 / 120
25x20	25 / 100
30x13	25 / 100
30x16	20 / 80
30x20	20 / 80
30x25	18 / 72
40x13	30 / 60
40x16	28 / 56
40x20	25 / 50
40x25	23 / 46
40x30	23 / 46
50x13	20 / 40
50x16	20 / 40
50x20	17 / 34
50x25	15 / 30
50x30	13 / 26
50x40	11 / 22

65x 40	18
65x 50	18
75x 25	18
75x 40	14
75x 50	12
75x 65	4
100x 50	6
100x 75	5
125x 75	4
125x100	3
150x 75	3
150x100	2
150x125	2

Faucet Elbow [FL]

Size (mm)	Packing: pcs.
13	150 / 600
16	110 / 440
20	70 / 280
25	40 / 160

Metal-Containing Faucet Elbow [KFL]

Size (mm)	Packing: pcs.
13	150 / 300
16	100 / 200
20	60 / 120
25	35 / 70
20x13	80 / 160

Faucet Socket [FS]

Size (mm)	Packing: pcs.
13	200 / 800
16	150 / 600
20	90 / 360
25	50 / 200

Metal-Containing Faucet Socket [KFS]

Size (mm)	Packing: pcs.
13	170 / 340
16	130 / 260
20	90 / 180
25	45 / 90
20x13	90 / 180

Faucet Tee [FT]

Size (mm)	Packing: pcs.
13	100 / 400
20	40 / 160
25	20 / 80
16x13	65 / 260
20x13	50 / 200
25x13	30 / 120
25x20	25 / 100

Metal-Containing Faucet Tee [KFT]

Size (mm)	Packing: pcs.
20	40 / 80
25	20 / 40
20x13	50 / 100
25x13	35 / 70
25x20	30 / 60

Valve Socket [VS]

Size (mm)	Packing: pcs.
13	250 / 1,000
16	180 / 720
20	110 / 440
25	60 / 240
30	40 / 160
40	50 / 100
50	30 / 60
65	60
75	36
100	18

Union Socket [US]

Size (mm)	Packing: pcs.
13	225 / 900
16	150 / 600
20	100 / 400
25	60 / 240
30	40 / 160
40	50 / 100
50	25 / 50

Socket [S]

Size (mm)	Packing: pcs.
13	210 / 840
16	130 / 520
20	85 / 340
25	50 / 200
30	35 / 140
40	40 / 80
50	24 / 48
65	30
75	22
100	10
125	8
150	4
16x13	160 / 640
20x13	120 / 480
20x16	100 / 400
25x13	70 / 280
25x16	65 / 260
25x20	60 / 240
30x20	40 / 160
30x25	40 / 160
40x20	50 / 100
40x25	50 / 100

40x 30	45 / 90
50x 20	40 / 80
50x 25	25 / 50
50x 30	25 / 50
50x 40	25 / 50
65x 40	40
65x 50	40
75x 40	30
75x 50	30
75x 65	30
100x 75	15
125x100	12
150x100	4
150x125	4

Cap [C]

Size (mm)	Packing: pcs.
13	420 / 1,680
16	250 / 1,000
20	170 / 680
25	100 / 400
30	70 / 280
40	80 / 160
50	40 / 80
65	60
75	36
100	18
150	6

Metal-Containing Valve Socket [KVS]

Size (mm)	Packing: pcs.
13	100 / 200

DV Fitting

90° Elbow [DL]

Size (mm)	Packing: pcs.
30	300
40	150
50	84
65	36
75	30
100	16
125	8
150	5

90° Large-Bend Elbow [LL]

Size (mm)	Packing: pcs.
40	110
50	56
65	26
75	22
100	10
125	5
150	4

45° Elbow [45L]

Size (mm)	Packing: pcs.
30	340
40	190
50	100
65	46
75	40
100	20
125	10
150	6

90° Y [DT]

Size (mm)	Packing: pcs.
30	180
40	100
50	50
65	24
75	24
100	12
125	6
150	4
50x 30	76
50x 40	66
65x 40	40
65x 50	34
75x 40	34
75x 50	34
75x 65	30
100x 40	24
100x 50	22
100x 65	16
100x 75	14
125x 75	8
125x100	8
150x 75	7
150x100	6

90° Large-Bend Y [LT]

Size (mm)	Packing: pcs.
40	70
50	34
65	18
75	16
100	8
125	4
150	3
50x 40	46
65x 40	30
65x 50	24
75x 40	30
75x 50	26
75x 65	20
100x 40	18
100x 50	14
100x 65	12
100x 75	12
125x 65	6
125x 75	6
125x100	4
150x 65	5
150x 75	5
150x100	4
150x125	3

90° Large-Bend Both Y [WLT]

Size (mm)	Packing: pcs.
65	10
75	8
100	4
100x 75	6
125x100	3

45° Y [Y]

Size (mm)	Packing: pcs.
40	70
50	40
65	20
75	16
100	8
125	4
150	3
50x 40	50
65x 40	30
65x 50	26
75x 40	32
75x 50	26
75x 65	20
100x 40	22
100x 50	16
100x 65	14
100x 75	10
125x100	5
150x100	4

Socket [DS]

Size (mm)	Packing: pcs.
40	280
50	160
65	74
75	70
100	34
125	14
150	12

Increaser [IN]

Size (mm)	Packing: pcs.
40x 30	270
50x 40	150
65x 40	130
65x 50	100
75x 40	120
75x 50	120
75x 65	90
100x 40	54
100x 50	54
100x 65	54
100x 75	48
125x 65	28
125x 75	28
125x100	25
150x 75	20
150x100	20
150x125	18

VU Fitting & Large-Size VU Fitting

Bend & Large-Size Fitting

90° Elbow [DL]

Size (mm)	Packing: pcs.
40	150
50	84
65	36
75	30
100	16
125	8
150	5

90° Large-Bend Elbow [LL]

Size (mm)	Packing: pcs.
50	56
75	22
100	10
125	5
150	4

45° Elbow [45L]

Size (mm)	Packing: pcs.
40	190
50	100
65	46
75	40
100	20
125	10
150	6

90°Y [DT]

Size (mm)	Packing: pcs.
50	50
65	24
75	24
100	12
125	6
150	4
65x 50	34
75x 50	34
75x 65	30
100x 50	22
100x 75	14
150x100	6

90° Large-Bend Y [LT]

Size (mm)	Packing: pcs.
50	34
75	16
100	8
125	4
150	3
65x 50	24
75x 50	26
75x 65	20
100x 50	14
100x 75	12
125x100	4
150x125	3

45°Y [Y]

Size (mm)	Packing: pcs.
50	40
75	16
100	8
125	4
150	3
75x50	26
100x50	16
100x75	10

Socket [DS]

Size (mm)	Packing: pcs.
40	280
50	160
65	74
75	70
100	34
125	14
150	12

Increaser [IN]

Size (mm)	Packing: pcs.
50x 40	150
65x 50	100
75x 50	120
75x 65	90
100x 50	54
100x 65	54
100x 75	48
125x100	25
150x100	20
150x125	18

AV90° Elbow [VU-DL]

Size (mm)	Packing: pcs.
200	4
250	2
300	1

45° Elbow [VU-45L]

Size (mm)	Packing: pcs.
200	4
250	2
300	1

Socket [VU-DS]

Size (mm)	Packing: pcs.
200	6
250	4
300	2

90°Y [VU-DT]

Size (mm)	Packing: pcs.
200	2
250	1
300	1

AV90° Bend

Size (mm)	Packing: pcs.
75	18
100	8
125	6
150	4
200	1
250	1
300	1

AV45° Bend

Size (mm)	Packing: pcs.
40	36
50	18
65	10
75	18
100	9
125	6
150	4
200	2
250	2
300	2

AV Short Elbow

Size (mm)	Packing: pcs.
200	2
250	1
300	1

AV Socket

Size (mm)	Packing: pcs.
200	4
250	2
300	2
200x150	2
250x200	2
300x250	1

AV Tee

Size (mm)	Packing: pcs.
200	1
250	1
300	1
200x 75	2
200x100	2
200x150	2
250x 75	1
250x100	1
250x200	1
300x 75	1

Piping Design Precautions

- Select an appropriate material in consideration of use conditions (fluid type, temperature, pressure, etc.) For details, please consult our nearest office in advance.
- Maximum working pressure is the pressure including the water hammer pressure. Do not use them exceeding the maximum working pressure.
- As maximum working pressure differs by size and temperature, design and use within the allowable range.
- Since they are made from plastic, heat expansion/contraction against temperature change is large compared to metals and heat stress is also generated. Therefore, perform piping support or expansion/construction treatment applicable to the use conditions and installation place.
- In the case of using under the positive-pressure gas, a dangerous condition is expected due to the particular reaction force of compressive fluid even when the value is the same as the water pressure. Therefore, implement a safety measure such as covering pipes with a protection material, etc. to protect the surrounding area before use.
- Do not joint with solvent adhesive or welding connection on differential plastic materials (It may cause damage)

Transportation Precautions

- Do not drag them as it could scratch pipes. Do not drag them as both ends of pipes are easily damaged.

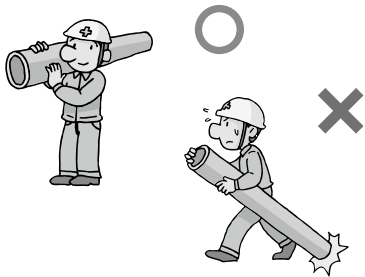

- Two people should handle a pipe with the size of 150 mm or more.

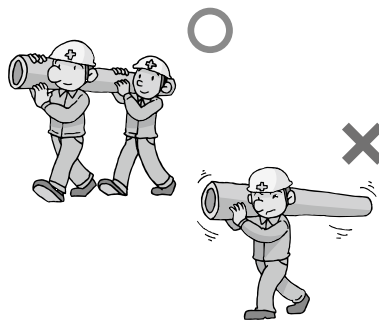

- Do not throw pipes from the truck platform.

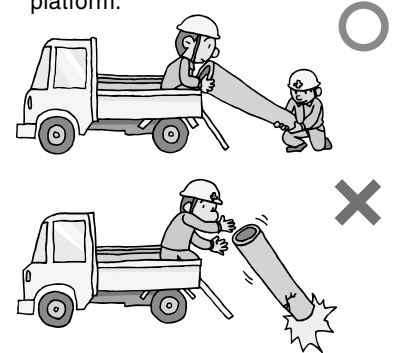

Storage Precautions

- When storing pipes and fittings outside, avoid direct sunlight and implement a measure such as placing a sheet in a way of avoiding heat accumulation.

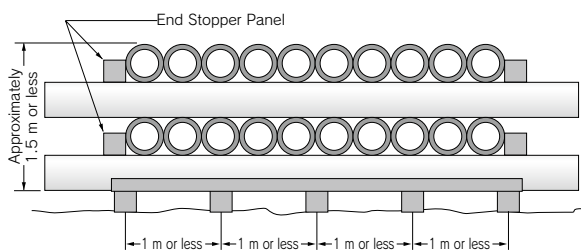

- Do not leave fittings in an enclosed condition (inside a vehicle in summer, in an enclosed plastic bag, etc.) under a high temperature atmosphere.

Enclosed vehicle
(may deform due to heat)

Packed products in a
sealed condition

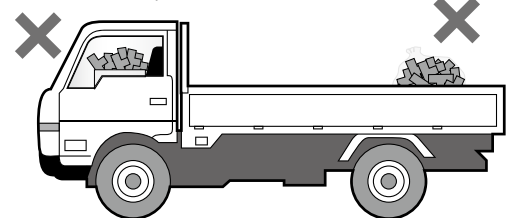

Installation

- Follow our installation procedure to fully exert the work safety and piping performance for installation.
- Make sure to use the specified AV cement for bonding AV PVC pipes.
- Be cautious of excessive adhesive (it may cause solvent cracking and damage). Caution is needed in low-temperature installation because solvent steam does not evaporate easily and tends to remain (it may cause solvent cracking and damage). During curing after piping, open both ends of pipe without enclosing and remove the solvent steam. During curing, it can be removed more effectively by ventilating inside piping using a ventilator (low-pressure specification) or washing inside piping by filling the water fully after the adhesive is hardened.
- Make sure to perform a completion inspection under water pressure. Do not perform an airtightness test by using air (compressed air or positive-pressure gas) as it is extremely dangerous.

Solvent Cracking (SC) Measure

SC (Solvent Cracking) is a type of stress cracking and specifically distinguishes the cracking phenomenon that occurs when solvent gives an impact inside PVC pipe. SC is caused by the existence of solvent (adhesive, preservative, etc.) It tends to occur more easily due to stress (heat stress, stress of TS connection part, bending, other external stress) and installation during low-temperature like in winter (solvent tends to remain). When piping, implement an SC measure as explained as follows.

Item	Measure
Adhesive Usage	Apply adhesive compatible to the type of pipe thinly and evenly. Do not apply adhesive extending out from the insertion length on the pipe outer face. In particular, apply thinly and evenly to the inner face of fitting. The reference ratio of adhesive application is 7 to 3 for pipe and fitting.
Wiping of Adhesive	After bonding, make sure to wipe off the protruded adhesive with a cloth after inserting. During application, remove the adhesive spilled on the groove floor.
Opening of pipe on both ends	Fully open valve, air valve, blind flange, etc. for better ventilation and remove the solvent steam (do not enclose).
Utilization of Prefab Method	Prefabricate 2 to 4 pipes in advance, remove the solvent steam by natural ventilation and then connect the pipes.
Ventilation inside Piping	During curing after piping, open both ends of pipe without enclosing and remove the solvent steam (do not enclose). During curing, the steam can be removed more effectively by ventilating inside piping using a ventilator (low-pressure specification).
Washing inside Piping	During curing after piping, open both ends of pipe without enclosing and remove the solvent steam. It is more effective if you fill water all the way and wash after the adhesive is hardened (do not apply the water pressure at this time). • Immediately perform this after leaving 30 minutes for the size of 50 mm or less and approximately 1 hour for the size of 65 mm or more.
Expansion Measure	Implement an expansion/contraction treatment to prevent the heat stress from rising due to temperature differences.
Support	When fixing piping, try to avoid using U-bolts as much as possible and use fixation bands with a wider width. In the case of using U-bolts, provide a cushion such as rubber to prevent piping from touching U-bolts. Be fully cautious not to tighten the fixation bands and U-bolts too much.

Adhesive Usage

Do not apply adhesive extending out from the gauge line.

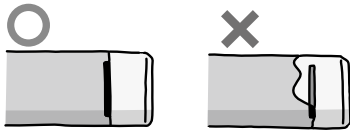

Apply thinly and evenly to the inner face of TS fitting gasket.

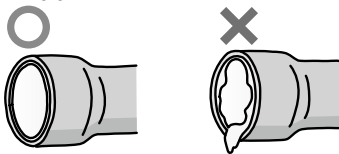

Expansion Measure

Provide expansion/contraction treatment to lower the heat stress.

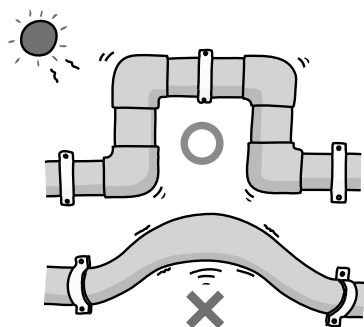

Wiping of Adhesive

Wipe off the protruded adhesive with a cloth after inserting.

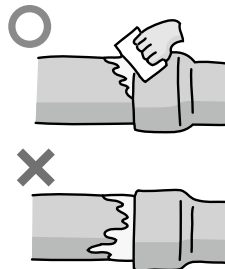

Support

Be cautious not to tighten saddle bands, U-bolts and U-bands too much.

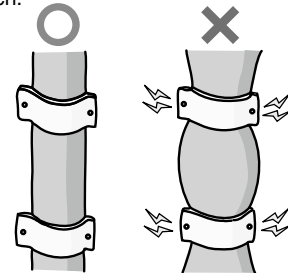

Removal of Solvent and Opening of Pipe on Both Ends

Ventilation

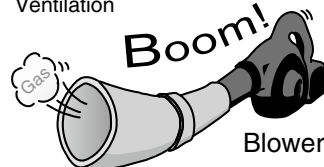

Washing with water



Opening of pipe on both ends

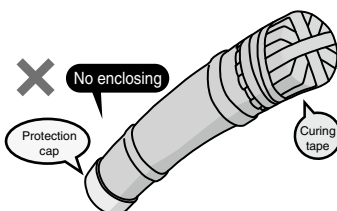
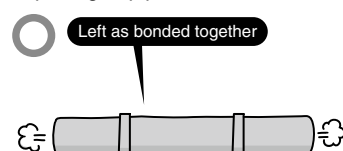

C-PVC Pipe & Fittings

C-PVC Pipe	P.066
C-PVC Fittings	P.067
Expansion Joint/Prefab Joint	P.075
Flange	P.077
Welding Rod	P.077
Technical Document	P.078



Heat-Resistant

PRODUCT MODEL CODE LIST

Type	Field	Material	Standard/Wall Thickness	Standard	Type	Size	Length
P	N	S	PP	J	N	***	**
⋮	⋮	⋮	⋮	⋮	⋮	⋮	⋮
P Pipe	N Standard	S Super	PP Straight Pipe VP	J JIS	N Standard	013 13mm I 200 200mm	04 4m 05 5m

Straight Pipe (C-PVC Pipe)

PRODUCT MODEL CODE

P N S PP J N Size

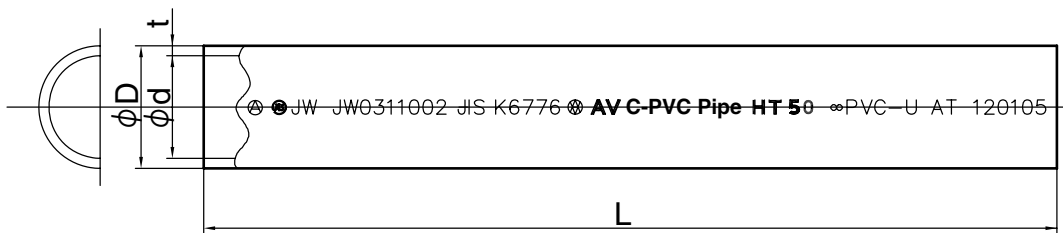

Dimensions Table

(Unit: mm)

Category	Outer Diameter	D		t		L		Approximate Inner Diameter (Reference)	Mass (kg/m) (Reference)
		Tolerance		Thickness		Length			
		Max/Min.	Average	Basic Dimension	Tolerance	Basic Dimension	Tolerance		
○ 13	18.0	±0.20	±0.20	2.5	±0.2	4000	+30 -10	13	0.180
○ 16	22.0	±0.20	±0.20	3.0	±0.3			16	0.265
○ 20	26.0	±0.20	±0.20	3.0	±0.3			20	0.321
○ 25	32.0	±0.20	±0.20	3.5	±0.3			25	0.464
○ 30	38.0	±0.30	±0.20	3.5	±0.3			31	0.561
○ 40	48.0	±0.30	±0.20	4.0	±0.3			40	0.818
○ 50	60.0	±0.40	±0.20	4.5	±0.4	4000 5000*	±10	51	1.161
□ 65	76.0	±0.50	±0.30	4.5	±0.4			67	1.496
□ 75	89.0	±0.50	±0.30	5.9	±0.4			77	2.279
□ 100	114.0	±0.60	±0.40	7.1	±0.5			100	3.528
□ 125	140.0	±0.80	±0.50	7.5	±0.5			125	4.620
□ 150	165.0	±1.00	±0.50	9.6	±0.7			146	6.935
□ 200*	216.0	±1.30	±0.70	11.0	±0.7	194	10.483		

- Notes: 1. ○ are JIS K6776 (Heat-Resistant Unplasticized Polyvinyl Chloride Pipe).
 2. □ conform to the AV standard. Dimensions are accordance with JIS K6741 (Unplasticized Polyvinyl Chloride Pipe).
 3. Size 200 and length 5 m are build-to-order products.

PRODUCT MODEL CODE LIST

Type	Field	Material	Model	Standard	Type	Size
T	N	S	**	J	N	***
⋮	⋮	⋮	⋮	⋮	⋮	⋮
T TS Fitting	N Standard	S Super	9L Elbow 4L 45° Elbow 45 45° Bend SO Socket TE Tee KS Faucet Socket (Metal contained) KL Faucet Elbow (Metal contained) KV Valve Socket (Metal contained)	J JIS	N Standard	013 13mm 150 150mm 013 13mm 016013 16×13mm 150125 150×125mm

Type	Field	Material	Model	Standard	Others	Size
B	N	S	45	V	N	***
⋮	⋮	⋮	⋮	⋮	⋮	⋮
B Bend	N None Color	S Super	45 45° Bend	V AV	N Normal Color	040 40mm 150 150mm

Type	Field	Material	Model	Standard	Others	Size
T	N	S	**	V	N	200
⋮	⋮	⋮	⋮	⋮	⋮	⋮
T TS Fitting	N Standard	S Super	9L 90° Elbow SO Socket	V AV	N Normal Color	200 200mm

C-PVC Fittings Connection Part Dimensions

A-Style (Injection Molding Product)

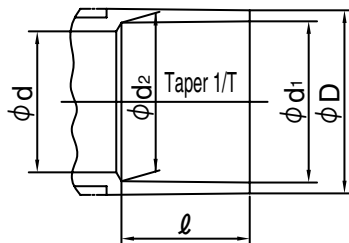

■ Dimensions Table

(Unit: mm)

Size	d ₁		l		d ₂		d (Min.)	D (Min.)	Taper 1/T
	Basic Dimension	Tolerance	Basic Dimension	Tolerance	Basic Dimension	Tolerance			
○ 13	18.30	±0.20	22	±4	17.55	±0.25	14	26	—
○ 16	22.35	±0.20	27	±4	21.55	±0.25	17	29	—
○ 20	26.35	±0.20	33	±4	25.50	±0.25	21	34	—
○ 25	32.50	±0.30	38	±4	31.40	±0.35	26	41	—
○ 30	38.50	±0.30	42	±4	37.45	±0.35	34	46	—
○ 40	48.50	±0.30	47	±4	47.45	±0.35	40	56	—
○ 50	60.50	±0.30	52	±4	59.45	±0.35	50	69	—
□ 65	76.60	±0.30	61	⁺⁴ _{-0.5}	—	—	67	87	1/48
□ 75	89.60	±0.30	64	⁺⁴ _{-0.5}	—	—	77	102	1/49
□ 100	114.70	±0.30	84	⁺⁴ _{-0.5}	—	—	100	130	1/56
□ 125	140.80	±0.30	104	⁺⁴ _{-0.5}	—	—	125	157	1/58
□ 150	166.00	±0.40	132	⁺⁴ _{-0.5}	—	—	146	186	1/63

Notes: 1. ○ are JIS K6777 (Heat-Resistant Unplasticized Polyvinyl Chloride Pipe Fitting). 2. □ conform to the AV standard. 3. Size 75, 100 and 150 are accordance with JIS K6743 (Tap Water Unplasticized Polyvinyl Chloride Pipe Fitting). 4. Size 65 and 125 are accordance with the association standard (AS 21).

C-PVC Fittings Connection Part Dimensions

Combination Type

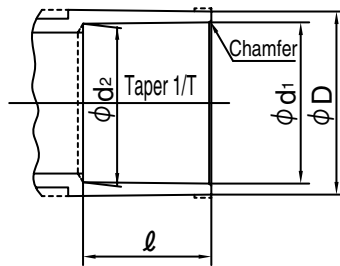

Dimensions Table

(Unit: mm)

Size	d ₁		l		d ₂ (Reference)	D		Taper 1/T
	Basic Dimension	Tolerance	Basic Dimension	Tolerance		Basic Dimension	Tolerance	
□ 13	18.40	±0.20	26	⁺⁴ / _{-0.5}	17.53	24	-0.60	1/30
□ 16	22.40	±0.20	30	⁺⁴ / _{-0.5}	21.52	29	-0.80	1/34
□ 20	26.45	±0.20	35	⁺⁴ / _{-0.5}	25.42	33	-0.80	1/34
□ 25	32.55	±0.25	40	⁺⁴ / _{-0.5}	31.37	40	-1.00	1/34
□ 30	38.60	±0.25	44	⁺⁴ / _{-0.5}	37.31	46	-1.00	1/34
□ 40	48.70	±0.30	55	⁺⁴ / _{-0.5}	47.21	57	-1.20	1/37
□ 50	60.80	±0.30	63	⁺⁴ / _{-0.5}	59.10	70	-1.50	1/37
□ 65	76.60	±0.30	61	⁺⁴ / _{-0.5}	75.33	87	-1.50	1/48
□ 75	89.60	±0.30	64	⁺⁴ / _{-0.5}	88.29	102	-1.50	1/49
□ 100	114.70	±0.30	84	⁺⁴ / _{-0.5}	113.20	130	-1.80	1/56
□ 125	140.80	±0.30	104	⁺⁴ / _{-0.5}	139.01	157	-1.80	1/58
□ 150	166.00	±0.40	132	⁺⁴ / _{-0.5}	163.91	186	-2.00	1/63

Notes: 1. □ conform to the AV standard. 2. Size 13, 20, 25, 30, 40, 50, 75, 100 and 150 are accordance with JIS K6743 (Tap Water Unplasticized Polyvinyl Chloride Pipe Fitting). 3. Size 16, 65 and 125 are accordance with the association standard (AS 21).

Elbow

Abbreviation: **L**

PRODUCT MODEL CODE

TS ▶ T N S 9L J N Size

Elbow (A-Style)

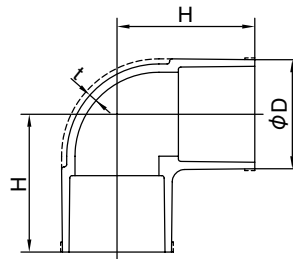

Dimensions Table

(Unit: mm)

Size	D (Min.)		t (Min.)	H		Size	D (Min.)		t (Min.)	H	
	Basic Dimension	Tolerance		Basic Dimension	Tolerance		Basic Dimension	Tolerance		Basic Dimension	Tolerance
○ 13	26	—	3.5	34	±4	○ 50	69	—	5.0	85	±4
○ 16	29	—	3.5	41	±4	□ 65	87	-1.5	6.6	110	⁺⁵ / ₋₁
○ 20	34	—	4.0	53	±4	□ 75	102	-1.5	8.0	120	⁺⁵ / ₋₁
○ 25	41	—	4.0	58	±4	□ 100	130	-1.8	10.0	155	⁺⁵ / ₋₁
○ 30	46	—	4.5	64	±4	□ 125	157	-1.8	11.0	188	⁺⁵ / ₋₁
○ 40	56	—	4.5	74	±4	□ 150	186	-2.0	13.0	228	⁺⁵ / ₋₁

Notes: 1. ○ are JIS K6777 (Heat-Resistant Unplasticized Polyvinyl Chloride Pipe Fitting). 2. □ conform to the AV standard. 3. Connection part dimensions are A-Style.

Short Elbow

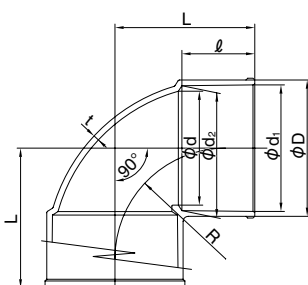

Dimensions Table

(Unit: mm)

Size	d ₁		d ₂		l		D	d	t		L	R
	Basic Dimension	Tolerance	Basic Dimension	Tolerance	Basic Dimension	Tolerance			Basic Dimension	Tolerance		
200	217	±1.0	214.5	±1.0	145	⁺⁴ / _{-0.5}	236	196	15	±0.8	265	190

Notes: 1. It conforms to the AV standard.

45° Elbow/Bend

Abbreviation: **45L**

PRODUCT MODEL CODE

20, 25	T	N	S	4L	J	N	Size
40 to 150	B	N	S	45	V	N	Size

45° Elbow



TS
C-PVC / HT

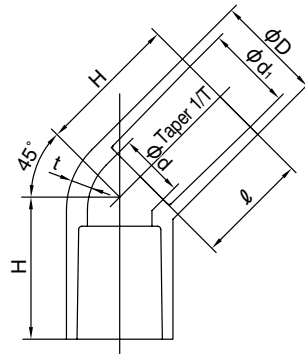

Dimensions Table

(Unit: mm)

Size	d ₁		Taper 1/T	ℓ		d	D		t		H	
	Basic Dimension	Tolerance		Basic Dimension	Tolerance		Basic Dimension	Tolerance	Basic Dimension	Tolerance	Basic Dimension	Tolerance
<input type="checkbox"/> 20	26.45	±0.25	1/34	35.0	⁺⁴ _{-0.5}	20	33.0	-0.8	3.5	-0.3	44	⁺⁵ ₋₁
<input type="checkbox"/> 25	32.55	±0.20	1/34	40.0	⁺⁴ _{-0.5}	25	40.0	-1.0	4.0	-0.4	51	⁺⁵ ₋₁

Notes: 1. conform to the AV standard.

45° Bend

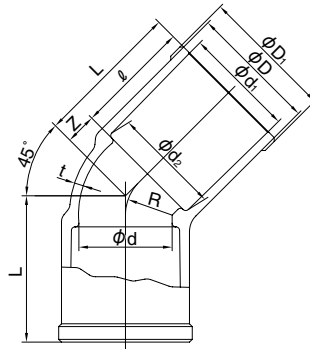

Dimensions Table

(Unit: mm)

Size	d ₁		d ₂		ℓ		D	D ₁	d (Min.)	t		Z	L	R
	Basic Dimension	Tolerance	Basic Dimension	Tolerance	Basic Dimension	Tolerance				Basic Dimension	Tolerance			
<input type="checkbox"/> 40	48.70	±0.30	47.21	±0.30	55	⁺⁴ _{-0.5}	57	60	40	4.5	^{+0.45} ₋₀	14	69	20.0
<input type="checkbox"/> 50	60.80	±0.30	59.10	±0.30	63	⁺⁴ _{-0.5}	70	73	51	5.0	^{+0.5} ₋₀	17	80	25.5
<input type="checkbox"/> 65	76.60	±0.30	75.33	±0.30	61	⁺⁴ _{-0.5}	87	90	67	6.6	^{+0.5} ₋₀	20	81	34.0
<input type="checkbox"/> 75	89.80	±0.30	88.13	±0.30	72	⁺⁴ _{-0.5}	101	104	78	6.0	^{+0.8} ₋₀	25	97	39.0
<input type="checkbox"/> 100	115.00	±0.35	112.89	±0.35	92	⁺⁴ _{-0.5}	129	132	100	7.3	^{+1.0} ₋₀	30	122	50.0
<input type="checkbox"/> 125	141.20	±0.40	138.71	±0.40	112	⁺⁴ _{-0.5}	156	160	125	7.7	^{+1.0} ₋₀	37	149	62.5
<input type="checkbox"/> 150	166.50	±0.50	163.39	±0.50	140	⁺⁴ _{-0.5}	185	189	148	10.0	^{+1.0} ₋₀	44	184	74.0

Notes: 1. conform to the AV standard.

Cap

Abbreviation: **C**

PRODUCT MODEL CODE

TS	T	N	S	CP	J	N	Size
----	---	---	---	----	---	---	------

Cap



TS
C-PVC / HT

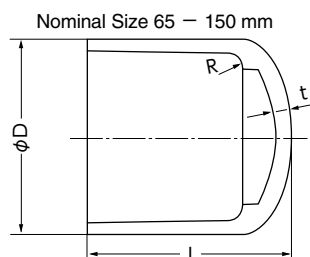

Dimensions Table

(Unit: mm)

Size	D	t	L
<input type="checkbox"/> 65	87 -1.5	8.6	96
<input type="checkbox"/> 75	102 -1.5	8.0	105
<input type="checkbox"/> 100	130 -1.8	10.0	138
<input type="checkbox"/> 150	186 -2.0	13.0	205

Notes: 1. L tolerance should be +5mm,0.
2. conform to the AV standard.
3. R tolerance should be 1 to 5mm.

Socket

Abbreviation: **S**

PRODUCT MODEL CODE

TS ▶ T N S SO J N Size

Socket (A-Style)



TS
C-PVC / HT

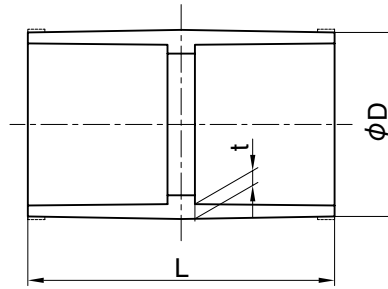

Dimensions Table

(Unit: mm)

Size	D (Min.)		L		t (Min.)
	Basic Dimension	Tolerance	Basic Dimension	Tolerance	
○ 13	26	—	49	±6.0	3.5
○ 16	29	—	59	±6.0	3.5
○ 20	34	—	71	±6.0	4.0
○ 25	41	—	82	±6.0	4.0
○ 30	46	—	89	±6.0	4.5
○ 40	56	—	99	±6.0	4.5
○ 50	69	—	109	±6.0	5.0
□ 65	87	-1.5	145	±6.0	4.6
□ 75	102	-1.5	155	±6.0	5.6
□ 100	130	-1.8	200	±6.0	6.9
□ 125	157	-1.8	231	±6.0	7.3
□ 150	186	-2.0	300	±6.0	9.2

- Notes: 1. ○ are JIS K6777 (Heat-Resistant Unplasticized Polyvinyl Chloride Pipe Fitting).
 2. □ conform to the AV standard.
 3. Connection part dimensions are A-Style.
 4. t dimension for size 65 to 150 is reference value (minimum).

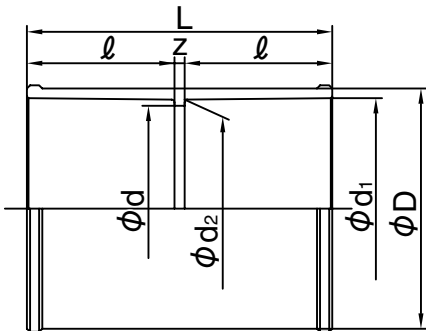

Dimensions Table

(Unit: mm)

Size	d ₁		d ₂		ℓ	D	d	Z	L
	Basic Dimension	Tolerance	Basic Dimension	Tolerance	Basic Dimension				
□200	217	±1.0	214.5	±1.0	145	238	202	15	305

- Notes: 1. □ conform to the AV standard.

Reducing Socket

Abbreviation: **S**

PRODUCT MODEL CODE

TS ▶ T N S SO J N Size

Reducing Socket (A-Style)



TS
C-PVC / HT

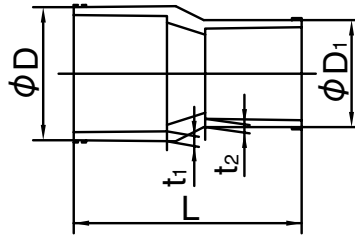

Dimensions Table

(Unit: mm)

Size	D (Min.)		D ₁ (Min.)		L		t ₁ (Min.)	t ₂ (Min.)
	Basic Dimension	Tolerance	Basic Dimension	Tolerance	Basic Dimension	Tolerance		
○ 16×13	29	—	26	—	53.0	±5	3.5	3.5
○ 20×13	34	—	26	—	61.5	±5	4.0	3.5
○ 20×16	34	—	29	—	66.0	±5	4.0	3.5
○ 25×13	41	—	26	—	73.0	±5	4.0	3.5
○ 25×16	41	—	29	—	76.0	±5	4.0	3.5
○ 25×20	41	—	34	—	80.5	±5	4.0	4.0
○ 30×13	46	—	26	—	75.0	±5	4.5	3.5
○ 30×20	46	—	34	—	85.0	±5	4.5	4.0
○ 30×25	46	—	41	—	90.0	±5	4.5	4.0
○ 40×20	56	—	34	—	98.0	±5	4.5	4.0
○ 40×25	56	—	41	—	100.0	±5	4.5	4.0
○ 40×30	56	—	46	—	97.0	±5	4.5	4.5
○ 50×25	69	—	41	—	110.0	±5	5.0	4.0
○ 50×30	69	—	46	—	110.0	±5	5.0	4.5
○ 50×40	69	—	56	—	110.0	±5	5.0	4.5
□ 65×50	87	-1.5	70	-1.5	149.0	±4	5.0	5.0
□ 75×50	102	-1.5	70	-1.5	165.0	±4	8.0	5.0
□ 75×65	102	-1.5	87	-1.5	163.0	±4	8.0	5.0
□ 100×75	130	-1.8	102	-1.5	190.0	±4	10.0	8.0

- Notes: 1. ○ are JIS K6777 (Heat-Resistant Unplasticized Polyvinyl Chloride Pipe Fitting).
 2. □ conform to the AV standard.
 3. Connection part dimensions are A-Style.

Reducing Socket (Combination type)



TS
C-PVC / HT

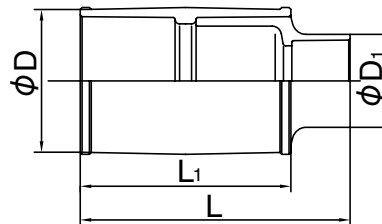

Dimensions Table

(Unit: mm)

Size	D	D ₁	D ₂	L	L ₁
□ 65× 30	87	46	70	194	149
□ 65× 40	87	57	70	205	149
□ 75× 40	102	57	70	221	165
□ 100× 40	130	57	102	246	190
□ 100× 50	130	70	102	252	190
□ 100× 65	130	87	102	250	190
□ 125× 75	157	102	—	296	231
□ 125×100	157	130	—	316	231
□ 150× 75	186	102	—	365	300
□ 150×100	186	130	—	385	300
□ 150×125	186	157	—	404	300

- Notes: 1. □ conform to the AV standard.
 2. Connection part dimensions are the combination type.

Tee

Abbreviation: **T**

PRODUCT MODEL CODE

TS ▶ T N S TE J N Size

Tee (A-Style)



TS
C-PVC / HT

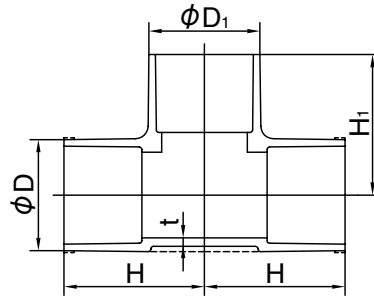

Dimensions Table

(Unit: mm)

Size	D (Min.)		t (Min.)	H		D1 (Min.)		H1	
	Basic Dimension	Tolerance		Basic Dimension	Tolerance	Basic Dimension	Tolerance	Basic Dimension	Tolerance
○ 13× 13	26	3.5	3.5	34	±4	26	—	34	±4
○ 16× 16	29	3.5	3.5	41	±4	29	—	41	±4
○ 20× 20	34	4.0	4.0	53	±4	34	—	53	±4
○ 25× 25	41	4.0	4.0	58	±4	41	—	58	±4
○ 30× 30	46	4.5	4.5	64	±4	46	—	64	±4
○ 40× 40	56	4.5	4.5	75	±4	56	—	75	±4
○ 50× 50	69	5.0	5.0	87	±4	69	—	87	±4
□ 65× 65	87 -1.5	6.6	6.6	110 ⁺⁵ ₋₁	87 -1.5	110 ⁺⁵ ₋₁	110 ⁺⁵ ₋₁	110 ⁺⁵ ₋₁	
□ 75× 75	102 -1.5	8.0	8.0	120 ⁺⁵ ₋₁	102 -1.5	120 ⁺⁵ ₋₁	120 ⁺⁵ ₋₁	120 ⁺⁵ ₋₁	
□ 100×100	130 -1.8	10.0	10.0	152 ⁺⁵ ₋₁	130 -1.8	152 ⁺⁵ ₋₁	152 ⁺⁵ ₋₁	152 ⁺⁵ ₋₁	
□ 125×125	157 -1.8	11.0	11.0	187 ⁺⁵ ₋₁	157 -1.8	187 ⁺⁵ ₋₁	187 ⁺⁵ ₋₁	187 ⁺⁵ ₋₁	
□ 150×150	186 -2.0	13.0	13.0	230 ⁺⁵ ₋₁	186 -2.0	230 ⁺⁵ ₋₁	230 ⁺⁵ ₋₁	230 ⁺⁵ ₋₁	

Notes: 1. ○ are JIS K6777 (Heat-Resistant Unplasticized Polyvinyl Chloride Pipe Fitting). 2. □ conform to the AV standard. 3. Connection part dimensions are A-Style.

Reducing Tee (A-Style)



TS
C-PVC / HT

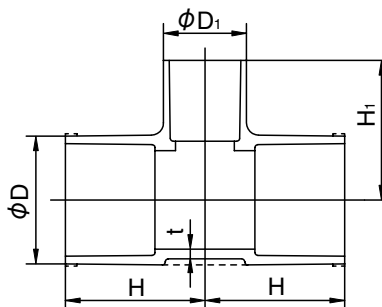

Dimensions Table

(Unit: mm)

Size	D (Min.)		t (Min.)	D1 (Min.)		H	H1	H and H1 Tolerance	Size	D (Min.)		t (Min.)	D1 (Min.)		H	H1	H and H1 Tolerance
	Basic Dimension	Tolerance		Basic Dimension	Tolerance					Basic Dimension	Tolerance		Basic Dimension	Tolerance			
○ 16× 13	29	3.5	3.5	26	39	36	±4	○ 50× 20	69	—	5.0	34	—	72	70	±4	
○ 20× 13	34	4.0	4.0	26	45	38	±4	○ 50× 25	69	—	5.0	41	—	75	75	±4	
○ 20× 16	34	4.0	4.0	29	47	43	±4	○ 50× 30	69	—	5.0	46	—	79	75	±4	
○ 25× 13	41	4.0	4.0	26	49	41	±4	○ 50× 40	69	—	5.0	56	—	82	80	±4	
○ 25× 16	41	4.0	4.0	29	52	46	±4	□ 65× 40	87	-1.5	6.6	57	-1.2	95	95	⁺⁵ ₋₁	
○ 25× 20	41	4.0	4.0	34	54	52	±4	□ 65× 50	87	-1.5	6.6	70	-1.5	102	104	⁺⁵ ₋₁	
○ 30× 13	46	4.5	4.5	26	54	44	±4	□ 75× 25	102	-1.5	8.0	40	-1.0	93	88	⁺⁵ ₋₁	
○ 30× 16	46	4.5	4.5	29	56	49	±4	□ 75× 40	102	-1.5	8.0	57	-1.2	100	102	⁺⁵ ₋₁	
○ 30× 20	46	4.5	4.5	34	58	55	±4	□ 75× 50	102	-1.5	8.0	70	-1.5	105	110	⁺⁵ ₋₁	
○ 30× 25	46	4.5	4.5	41	60	60	±4	□ 100× 50	130	-1.8	10.0	70	-1.5	125	122	⁺⁵ ₋₁	
○ 40× 13	56	4.5	4.5	26	62	49	±4	□ 100× 75	130	-1.8	10.0	102	-1.5	140	132	⁺⁵ ₋₁	
○ 40× 16	56	4.5	4.5	29	63	54	±4	□ 125× 75	157	-1.8	12.0	102	-1.5	161	147	⁺⁵ ₋₁	
○ 40× 20	56	4.5	4.5	34	65	60	±4	□ 125×100	157	-1.8	12.0	130	-1.8	175	167	⁺⁵ ₋₁	
○ 40× 25	56	4.5	4.5	41	68	65	±4	□ 150× 75	186	-2.0	13.0	102	-1.5	195	158	⁺⁵ ₋₁	
○ 40× 30	56	4.5	4.5	46	72	69	±4	□ 150×100	186	-2.0	13.0	130	-1.8	208	182	⁺⁵ ₋₁	
○ 50× 13	69	5.0	5.0	26	69	55	±4	□ 150×125	186	-2.0	13.0	157	-1.8	218	202	⁺⁵ ₋₁	
○ 50× 16	69	5.0	5.0	29	70	60	±4										

Notes: 1. ○ are JIS K6777 (Heat-Resistant Unplasticized Polyvinyl Chloride Pipe Fitting). 2. □ conform to the AV standard. 3. Connection part dimensions are A-Style.

Tee

Abbreviation: **T**

PRODUCT
MODEL CODE

TS ▶ T N S TE J N Size

Reducing Tee (Combination Type)



TS
C-PVC / HT

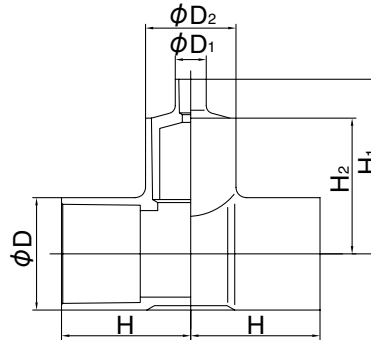

Dimensions Table

(Unit: mm)

Size	D	D ₁	D ₂	H	H ₁	H ₂
□ 65×13	87	24	70	100	135	105
□ 65×16	87	29	70	100	137	105
□ 65×20	87	33	70	100	142	105
□ 65×25	87	40	70	100	147	105
□ 65×30	87	46	70	100	150	105
□ 75×20	102	33	70	105	147	110
□ 75×30	102	46	70	105	155	110
□ 100×20	134	33	70	125	159	122
□ 100×25	134	40	70	125	164	122
□ 100×30	134	46	70	125	167	122
□ 100×40	134	57	70	125	178	122

Notes: 1. □ conform to the AV standard. 2. Connection part dimensions are the combination type.

Faucet Socket (A-Style) (Metal Insert Included)

Abbreviation: **KFS**

PRODUCT
MODEL CODE

TS ▶ T N S KS J N Size



TS
C-PVC / HT

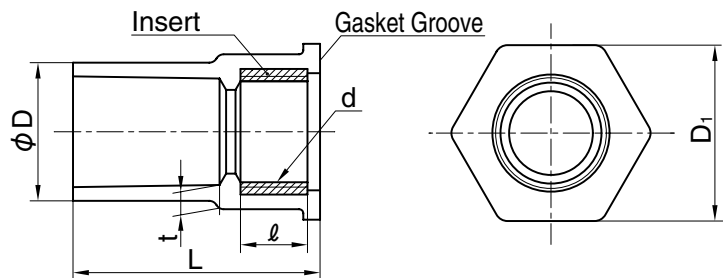

Dimensions Table

(Unit: mm)

Size	D (Min.)	Threaded End		ℓ		D ₁	L		t (Min.)
		Root Diameter D ₁	Number of Threads (per 25.4 mm)	Basic Dimension	Tolerance		Basic Dimension	Tolerance	
○13	26	20.955	14	13.5	±1	35	47	±4	3.5
○16×13	29	20.955	14	13.5	±1	35	52	±4	3.5
○20	34	26.441	14	15.5	±1	44	61	±4	4.0
○25	41	33.249	11	18	±1	54	69	±4	4.0
□20×13	33	20.955	14	14	±1	35	57	±4	4.0

Notes: 1. ○ are JIS K6777 (Heat-Resistant Unplasticized Polyvinyl Chloride Pipe Fitting).

2. □ conform to the AV standard.

3. Connection part dimensions are A-Style.

4. Insert material of threaded end is CAC406 of JIS H5120 and CAC406406C of JIS H5121 or free-cutting brass of JIS H3250.

5. Threaded end is parallel female thread of JIS B0203.

<Use Precautions>

* Use both seal tape and gasket for connection of threaded ends. Do not use liquid seal or liquid gasket.

Faucet Elbow (A-Style) (Metal Insert Included)

Abbreviation: **KFL**

PRODUCT
MODEL CODE

TS ▶ T N S KL J N Size



TS
C-PVC / HT

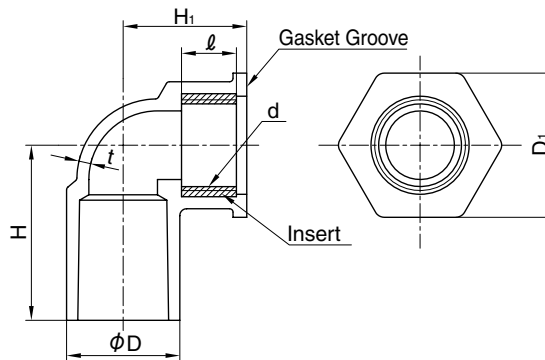

Dimensions Table

(Unit: mm)

Size	D (Min.)	t (Min.)	H	Threaded End		l		D1	H1	
				Root Diameter D1	Number of Threads (per 25.4 mm)	Basic Dimension	Tolerance		Basic Dimension	Tolerance
○13	26	3.5	35	20.955	14	13.5	±1	35	29	±4
○16×13	29	4.8	42	20.955	14	13.5	±1	35	33	±4
○20	34	4.0	51	26.441	14	15.5	±1	44	36	±4
○25	41	4.0	60	33.249	11	18	±1	54	40	±4
□20×13	36	4.8	47	20.955	14	14	±1	35	35	±4

- Notes: 1. ○ are JIS K6777 (Heat-Resistant Unplasticized Polyvinyl Chloride Pipe Fitting).
 2. □ conform to the AV standard.
 3. Connection part dimensions are A-Style.
 4. Insert material of threaded end is CAC406 of JIS H5120 and CAC406406C of JIS H5121 or free-cutting brass of JIS H3250.
 5. Threaded end is parallel female thread of JIS B0203.

<Use Precautions>

* Use both seal tape and gasket for connection of threaded ends. Do not use liquid seal or liquid gasket.

Valve Socket with Metal Male Thread (A-Style)

Abbreviation: **KVS**

PRODUCT
MODEL CODE

TS ▶ T N S KV J N Size



TS
C-PVC / HT

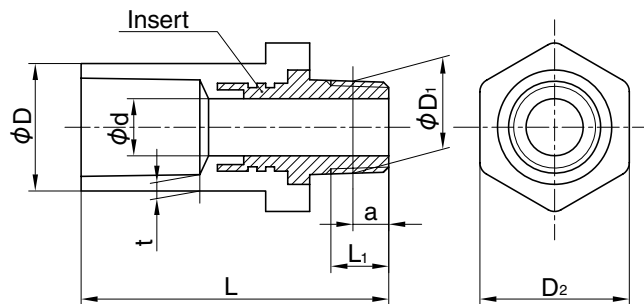

Dimensions Table

(Unit: mm)

Size	D (Min.)	d	Threaded End				L		D2 (Min.)	t (Min.)	
			Standard Outer Shape D1	Number of Threads (per 25.4 mm)	Standard Position a	a Tolerance	Effective threaded Length L1 (Min.)	Basic Dimension			Tolerance
○13× 1/2	26	13	20.955	14	8.16	±1.81	13.16	64	±4	34	3.5
○16× 1/2	29	13	20.955	14	8.16	±1.81	13.16	70	±4	34	3.5
○20× 3/4	34	18	26.441	14	9.53	±1.81	14.53	85	±4	40	4.0
○25×1	41	23	33.249	11	10.39	±2.31	16.79	99	±4	45	4.0
○30×11/4	46	31	41.910	11	12.70	±2.31	19.10	109	±4	62	4.5
○40×11/2	56	37	47.803	11	12.70	±2.31	19.10	114	±4	68	4.5
○50×2	69	48	59.614	11	15.88	±2.31	23.38	132	±4	84	5.0

- Notes: 1. ○ are JIS K6777 (Heat-Resistant Unplasticized Polyvinyl Chloride Pipe Fitting).
 2. Connection part dimensions are A-Style.
 3. Insert material of threaded end is CAC406 of JIS H5120 and CAC406406C of JIS H5121 or free-cutting brass of JIS H3250.
 4. Threaded end is tapered male thread of JIS B0203.

<Use Precautions>

* Use both seal tape and gasket for connection of threaded ends. Do not use liquid seal or liquid gasket.

PRODUCT MODEL CODE LIST

Model	Material	Rubber	Connection	Standard	Size
JEP	S	*	T	J	***
⋮	⋮	⋮	⋮	⋮	⋮
JEP Expansion Joint	S Super	E EPDM V FKM F Viflon®/FKM-F C Viflon®C/FKM-C	T Socket	J JIS	020 20mm 100 100mm

Expansion Joint



Features

- Expansion/contraction absorption margin is large and the thermal stress of piping is absorbed.
- Easy removal from piping by just loosening the union nut.
- No need for a large piping space with the compact design.
- No need for installation of piping expansion U bend.
- No slipping of pipe. (Because stop ring ⑤ is provided)

Dimensions Table

(Unit: mm)

Size		d	d ₁	ℓ ₁	1/T	D ₂	D ₁	D ₃	L		ℓ ₂
mm	inch								Max.	Min.	Expansion/Contraction Margin
20	3/4	20	26.13	24	1/34	35	60	35	243	163	80
25	1	25	32.16	27	1/34	43	70	39	250	170	80
30	1 1/4	31	38.19	30	1/34	50	82	47	258	178	80
40	1 1/2	40	48.21	37	1/37	59	100	59	272	192	80
50	2	51	60.25	42	1/37	72	106	72	285	205	80
65	2 1/2	65	76.60	61	1/48	88	133	88	314	234	80
75	3	78	89.60	64	1/49	105	152	105	330	250	80
100	4	100	114.70	84	1/56	132	210	132	422	322	100

Parts Table

No.	Description	Pcs.	Material
①	Body	1	C-PVC
②	End Connector (A)	1	C-PVC
③	End Connector (B)	1	C-PVC
④a	Union Nut (A)	-	C-PVC
④b	Union Nut (B) ¹⁾	1	C-PVC
⑤	Stop Ring	1	C-PVC
⑥	O-Ring (A)	1	EPDM, FKM, Viflon®F (FKM-F), Viflon®C (FKM-C)
⑦	O-Ring (B)	2	EPDM, FKM, Viflon®F (FKM-F), Viflon®C (FKM-C)

1) Use for 65-100mm.

<Use Precautions>

- Make sure to provide the first support (loose support) at 0.5 m or less of an expansion joint on both sides.
- Sufficiently consider the expansion and contraction amounts of piping. (When piping expands: Use the expansion joint being extended to a certain degree.) (When piping contracts: Use the expansion joint being shrunk to a certain degree.)

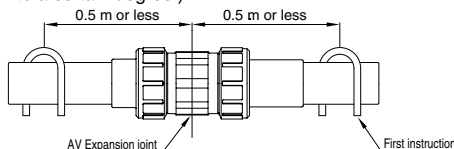

PRODUCT MODEL CODE	EPDM	▶ JEP S E T J Size
	FKM	▶ JEP S V T J Size
	Viflon®F / FKM-F	▶ JEP S F T J Size
	Viflon®C / FKM-C	▶ JEP S C T J Size

Main Specification

Material	Working Temperature	Maximum Working Pressure (Normal Temperature) MPa(kgf/cm ²)	Connection Socket End
Heat-Resistant Polyvinyl Chloride (C-PVC)	5 – 90°C	1.0{10.2}	○

Dimensions Diagram

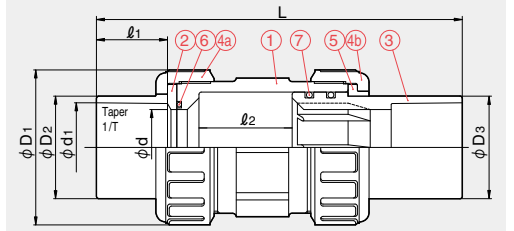

When installing

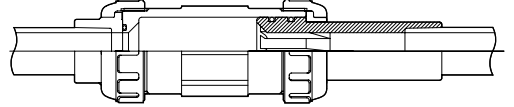

When piping is expanded by heat

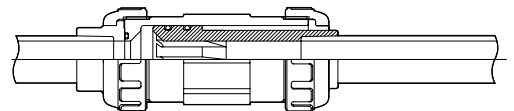

Pipe Heat Expansion Table

(Unit: mm)

Temperature Difference	Piping Length L								
	5m	10m	20m	30m	40m	50m	60m	70m	80m
10°C	4	7	14	21	28	35	42	49	56
20°C	7	14	28	42	56	70	84	98	112
30°C	11	21	42	63	84	105	126	147	168
40°C	14	28	56	84	112	140	168	196	224
50°C	18	35	70	105	140	175	210	245	280
60°C	21	42	84	126	168	210	252	294	336
70°C	25	49	98	147	196	245	294	343	392
80°C	28	56	112	168	224	280	336	392	448

<Example>How often (every XX m) shall expansion joints be inserted when the size is 75 mm and temperature difference is 20°C?

Calculation Formula $L = \frac{\Delta \ell}{\alpha \Delta t} \dots \dots \dots (1)$

- L : Length of piping that the expansion joint absorbs (mm)
- Δℓ : Piping expansion/contraction length
Expansion/contraction margin for 75 mm from the dimensions table ℓ₂=80 mm
Give margins on both ends 5 mm×2=10 mm Δℓ :=(80-10) mm
- α : Heat expansion coefficient of hard polyvinyl chloride pipe 7×10⁻⁵ (/°C)
- Δt : Temperature difference 20 (°C)

When the value above is assigned to (1) $L = \frac{80-10}{7 \times 10^{-5} \times 20} = 50000\text{mm}$

∴ One piece per 50m.

PRODUCT MODEL CODE LIST

Model	Material	Rubber	Connection	Standard	Size
JPF	C	*	T	J	***
⋮	⋮	⋮	⋮	⋮	⋮
JPF Prefab Joint	C C-PVC	E EPDM V FKM F Viflon®F/FKM-F C Viflon®C/FKM-C	T Socket	J JIS	013 13mm I 100 100mm

Prefab Joint

PRODUCT MODEL CODE	EPDM	▶	JPF	C	E	T	J	Size
	FKM	▶	JPF	C	V	T	J	Size
	Viflon®F/FKM-F	▶	JPF	C	F	T	J	Size
	Viflon®C/FKM-C	▶	JPF	C	C	T	J	Size



Features

- Installation is extremely simple and it can be done quickly and certainly. (Especially necessary for sleeve bonding/screw-in piping)
- Installable on piping where suitable and easy cleaning inside pipes.
- After installing piping, the valve parts can be removed by just loosening the union nut. It is suitable for pipelines requiring regular removals such as temporary piping and slurry piping.

Main Specification

Material	Heat-Resistant Polyvinyl Chloride (C-PVC)
Working Temperature	0 – 90°C
Maximum Working Pressure	1.0MPa{10.2kg/cm ² }

Prefab Joint Standard Table

Body Material	Connection Method	13	16	20	25	30	40	50	65	75	100
C-PVC	Socket End	○	○	○	○	○	○	○	○	○	○

Socket End (13 – 50 mm)

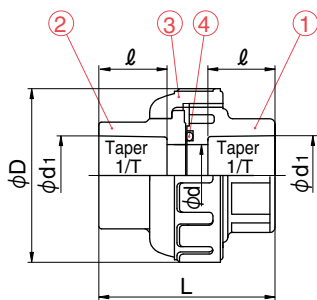

Socket End (65 – 100 mm)

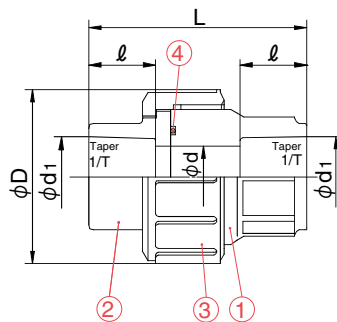

Parts Table

No.	Description	pcs.	Material
①	Body	1	C-PVC
②	End Connector	1	C-PVC
③	Union Nut	1	C-PVC
④	O-Ring	1	EPDM FKM Viflon®F/FKM-F Viflon®C/FKM-C

Dimensions Table

(Unit: mm)

Size	d	Socket end				D
		C-PVC				
		d ₁	ℓ	1/T	L	
13	13	18.13	18	1/30	46	48
16	15	22.11	20	1/34	46	48
20	20	26.13	24	1/34	61	60
25	25	32.16	27	1/34	70	70
30	31	38.19	30	1/34	77	82
40	40	48.21	37	1/37	95	100
50	51	60.25	42	1/37	107	106
65	65	76.60	61	1/48	167	133
75	77	89.60	64	1/49	189.5	152
100	100	114.70	84	1/56	245	210

PRODUCT MODEL CODE LIST

Type	Field	Model	Material	Standard	Size
F	N	T	C	*	***
⋮	⋮	⋮	⋮	⋮	⋮
F Flange	N None Color	T TS Flange	C C-PVC	1 JIS 10K 5 JIS 5K	013 13mm I 200 200mm

TS Flange

PRODUCT MODEL CODE

JIS 10K	▶	F	N	T	C	1	Size
JIS 5K	▶	F	N	T	C	5	Size

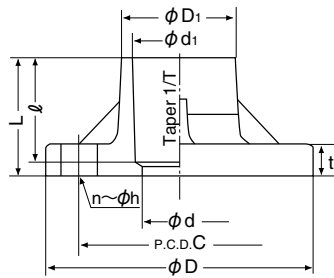

C-PVC JIS 10K 13 – 150 mm, JIS 5K 13 – 65 mm

Dimensions Table

(Unit: mm)

Size	d	d ₁	Taper 1/T	l	D ₁		C		D		pcs.		h		t		L	
					10K	5K	10K	5K	10K	5K	10K	5K	10K	5K	10K	5K	10K	5K
13	15	18.40	1/30	26	28	24	65	55	90	75	4	4	15	12	14	9	30	30
15	18	22.40	1/34	30	33	31	70	60	95	80	4	4	15	12	14	9	35	35
20	22	26.45	1/34	35	36	33	75	65	100	85	4	4	15	12	14	10	40	40
25	25	32.55	1/34	40	43	43	90	75	125	95	4	4	19	12	16	10	50	45
32	30	38.60	1/34	44	51	51	100	90	135	115	4	4	19	15	16	12	50.5	50
40	41	48.70	1/37	55	65	65	105	95	140	120	4	4	19	15	16	12	65	61
50	52	60.80	1/37	63	76	76	120	105	155	130	4	4	19	15	20	14	74	72
65	67	76.80	1/41	69	92	86	140	130	175	155	4	4	19	15	22	14	82	76
80	78	89.80	1/43	72	108	-	150	-	185	-	8	-	19	-	22	-	86	-
100	100	115.00	1/44	92	138	-	175	-	210	-	8	-	19	-	22	-	105	-
125	125	141.20	1/45	112	165	-	210	-	250	-	8	-	23	-	22	-	114	-
150	146	166.00	1/63	132	185	-	240	-	280	-	8	-	23	-	26	-	142	-
* 200	196	217.00	1/50	145	238	-	290	-	330	-	12	-	23	-	28	-	156	-

Notes: 1. Dimensions for C, D, n and h are accordance with the JIS 10K • 5K standards. 2. * Size 200 is build-to-order products.

PRODUCT MODEL CODE LIST

Type	Material			
S	S	*	*	0
⋮	⋮	⋮	⋮	⋮
S Welding Rod	S Super	2 2 mm 3 3 mm	1 Single 2 Double	0

Welding Rod

PRODUCT MODEL CODE

2mm×single	▶	S	S	2	1	0
3mm×single	▶	S	S	3	1	0
3mm×double	▶	S	S	3	2	0



- 2mm x single
- 3mm x single
- 3mm x double

* Color of welding rod is brown, same as C-PVC Pipe.

Technical Data

Property (Basic Property)

	Characteristics	Unit	JIS K6776	Asahi AV C-PVC Pipe
			Heat-Resistant Unplasticized Polyvinyl Chloride Pipe Standard (Applicable area 13 to 50 mm)	(Heat-Resistant Unplasticized Polyvinyl Chloride Pipe)
Physical Property	Specific Gravity	-	Not specified	1.48
	Absorption Amount	mg/cm ²	Not specified	0.03 - 0.05
	Linear Expansion Coefficient	°C ⁻¹	Not specified	6 to 8×10 ⁻⁵
	Specific Heat	cal/g/°C	Not specified	0.2 - 0.3
	Heat Conductivity	kcal/mh °C	Not specified	0.10 - 0.12
	Combustibility	-	Not specified	Self-Extinguishing Ability
	Vicat Softening Temperature	°C	95 or higher	100 - 110
Mechanical Property	Tensile Yield Stress	MPa	50 or more/23°C	50 - 65
	Extension Ratio	%	Not specified	40 or more
	Bending Strength	MPa	Not specified	78
	Compression Strength	MPa	Not specified	78 - 88
	Shear Strength	MPa	Not specified	52 - 55
	Vertical Modulus of Elasticity	MPa	Not specified	3×10 ³
	Poisson's Ratio	-	Not specified	0.38
	Charpy Impact Strength V-Notch	kJ/m ²	Not specified	8 - 10
	Flat Strength	-	Compress a circle test piece of 50 mm to 1/2 of pipe outer diameter and confirm no breaking and cracking.	Pass

Relationship between Maximum Working Pressure and Temperature

JIS K6776 Heat-Resistant Unplasticized Polyvinyl Chloride Pipe Standard (Applicable area 13 to 50 mm) Unit: MPa {kgf/cm²}

Size mm \ Temperature	5 - 40°C	41 - 60°C	61 - 70°C	71 - 90°C
13 - 50	1.0 {10.2}	0.6 {6.1}	0.4 {4.1}	0.2 {2.0}

C-PVC Pipe

Unit: MPa {kgf/cm²}

Size mm \ Temperature	Up to 40°C	Up to 50°C	Up to 60°C	Up to 65°C	Up to 70°C	Up to 75°C	Up to 80°C	Up to 85°C	Up to 90°C
13 - 25	1.0 {10.2}	0.9 {9.2}	0.8 {8.2}	0.7 {7.1}	0.6 {6.1}	0.5 {5.1}	0.45 {4.6}	0.35 {3.6}	0.3 {3.1}
30 - 50	1.0 {10.2}	0.8 {8.2}	0.6 {6.1}	0.6 {6.1}	0.4 {4.1}	0.35 {3.6}	0.3 {3.1}	0.25 {2.6}	0.2 {2.0}
65 - 150	1.0 {10.2}	0.8 {8.2}	0.6 {6.1}	0.5 {5.1}	0.4 {4.1}	0.3 {3.1}	0.2 {2.0}	0.2 {2.0}	0.15 {1.5}
200	0.7 {7.1}	0.55 {5.6}	0.4 {4.1}	0.3 {3.1}	0.2 {2.0}	0.15 {1.5}	0.1 {1.0}	0.05 {0.5}	0.05 {0.5}

Notes: Maximum Working Pressure is the pressure including the water hammer pressure. Do not use them exceeding the maximum working pressure.

Short-Term Strength Test

Temperature Dependence of Tensile Strength

Relationship of Tensile Strength and Temperature between C-PVC and Other Plastics

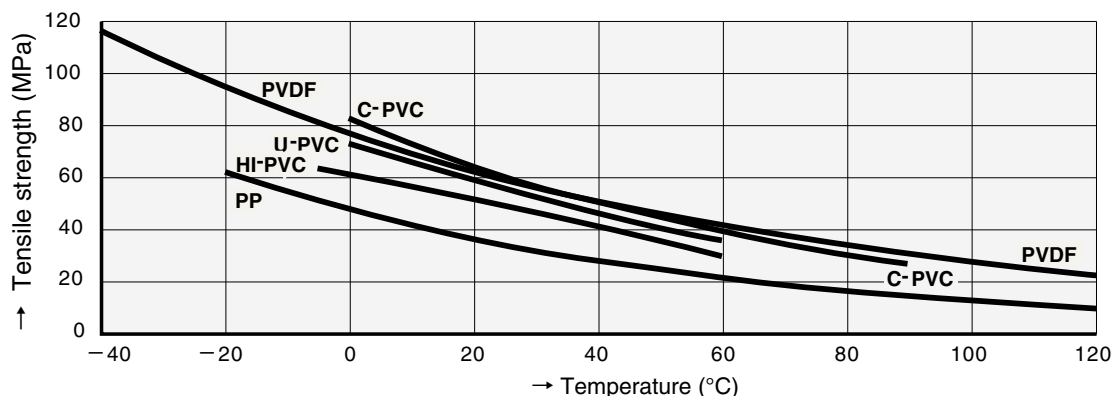

Notes: Tension speed..... 10 mm/min

C-PVC Pipe & Fittings

Elbow [L]

Size (mm)	Package: pcs.
13	100/200
16	60/120
20	35/70
25	20/40
30	40
40	25
50	15
65	14
75	10
100	5
125	5
150	3
200	2

45° Elbow [45L]

Size (mm)	Package: pcs.
20	40/80
25	25/50

45° Bend [45L]

Size (mm)	Package: pcs.
40	36
50	18
65	10
75	18
100	9
125	6
150	4

Tee [T]

Size (mm)	Package: pcs.
13	60/120
16	40/80
20	20/40
25	12/24
30	25
40	15
50	9
65	10
75	6
100	4
125	3
150	2
16x 13	50/100
20x 13	30/60
20x 16	25/50
25x 13	20/40
25x 16	15/30
25x 20	15/30
30x 13	35
30x 16	35
30x 20	35
30x 25	30
40x 13	25
40x 16	24

40x 20	22
40x 25	20
40x 30	20
50x 13	18
50x 16	18
50x 20	15
50x 25	15
50x 30	12
50x 40	12
65x 13	13
65x 16	13
65x 20	12
65x 25	12
65x 30	12
65x 40	17
65x 50	12
75x 20	9
75x 25	14
75x 30	8
75x 40	10
75x 50	10
100x 20	6
100x 25	5
100x 30	5
100x 40	5
100x 50	6
100x 75	5
125x 75	4
125x100	3
150x 75	3
150x100	2
150x125	2

Socket [S]

Size (mm)	Package: pcs.
13	120/240
16	90/180
20	50/100
25	30/60
30	60
40	35
50	20
65	30
75	16
100	8
125	4
150	4
200	4
16x 13	100/200
20x 13	70/140
20x 16	60/120
25x 13	40/80
25x 16	40/80
25x 20	35/70
30x 13	90
30x 20	70
30x 25	60
40x 20	45
40x 25	40

40x 30	40
50x 25	30
50x 30	30
50x 40	35
65x 30	25
65x 40	14
65x 50	28
75x 40	15
75x 50	20
75x 65	16
100x 40	8
100x 50	8
100x 65	8
100x 75	8
125x 75	3
125x100	3
150x 75	3
150x100	3
150x125	3

Metal-Containing Faucet Elbow [KFL]

Size (mm)	Package: pcs.
13	80
16	60
20	35
25	20
20x 13	50

Metal-Containing Faucet Socket [KFS]

Size (mm)	Package: pcs.
13	90
16	90
20	45
25	25
20x 13	45

Metal-Containing Valve Socket [KVS]

Size (mm)	Package: pcs.
13	70
16	60
20	40
25	25
30	12
40	9
50	10

Super Welding Rod

Size	Package
2 φ × S	(1kg×5) 5kg
3 φ × S	(1kg×5) 5kg
3 φ × W	(1kg×5) 5kg

Super Adhesive No.88

	Package: pcs.
250g	12/24
500g	12/24

C-PVC Pipe

Size (mm)	Package: pcs.
13	30
16	25
20	20
25	15
30	12
40	8
50	6
65	4
75	3
100	2
125	1
150	1
200	1

Installation of C-PVC Pipe/TS Connection



1 Pipe Cutting

Use wide thick paper or tape for the pipe cutting area, put a cutting gauge line with a permanent marker on the entire circumference, and cut perpendicular to the pipe shaft.



2 Chamfer

Lightly chamfer the entire inner/outer perimeters using a tool such as file or chamfer. When a pipe is cut, especially, finish the pipe end surface without burrs and warping.

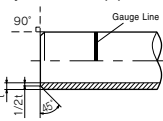

Notes: Not properly performing chamfering could cause installation failure so please make sure to chamfer.



3 Entry of Gauge Line

For the pipe insertion gauge line of the sizes 13 to 40 mm, measure the fitting socket length ℓ from the pipe end and mark on the pipe body with a marker. For the pipe insertion gauge line for the sizes 50 to 150 mm, it shall be at a position of the zero point plus the bonding margin length in Table 2. Mark the gauge line on the pipe body with a permanent marker.

Table 1. TS Fitting Socket Normal Length Unit: mm

Size	13	16	20	25	30	40	50	65	75	100	125	150
Fitting Socket Length	22	27	33	38	42	47	52	61	64	84	104	132

[Reference] Table 2. Bonding Margin Length Unit: mm

Size	13	16	20	25	30	40	50	65	75	100	125	150
Bonding Margin Length	7	9	11	13	14	16	17	20	25	30	35	45

* Refer to [Explanation] 2.



4 Rinsing

Wipe and clean the inner face of fitting socket and the outer face of pipe insertion port with a cloth. In particular, when oil or water is on the connection part, clean by using a small amount of acetone and alcohol.

Notes: Not properly performing rinsing could cause installation failure so please make sure to rinse.



5 Adhesive Application

Use a special adhesive (No.88) compatible to the type of pipe and apply it evenly in the order of on the inner face of fitting and the outer face of pipe. In particular, apply thinly and evenly to the inner face of fitting. The reference ratio of adhesive application is 7 to 3 for pipe and fitting.

Table 3. Usage of Adhesive per Connection Part (Reference)

Size (mm)	13	16 (15)	20	25	30 (32)	40	50	65	75	100	125	150
Usage (g)	0.9	1.2	1.7	2.0	3.1	5.0	7.1	9.9	12	20	30	44

* Refer to [Explanation] 4.



6 Insertion

After applying adhesive, insert pipe into fitting straight without turning the pipe immediately at once and press it in that condition. Refer to Table 4 for this normal press time.

Table 4. Normal Press Time of TS Connection

Size (mm)	50 or less	65 or more
Normal Press Time (Sec.)	30 or more	60 or more

* Use an inserter for large diameters.

Notes: Due to the relationship of pipe and fitting dimension tolerance, it may not be inserted all the way to the end. In this case, do not insert it forcibly by hammering and such. Inserting forcibly may place a large burden on the fitting and cause damage.



7 Adhesive Treatment

After connection, wipe the protruded adhesive immediately and do not apply forcible stress on the connection part.



8 Removal of Solvent Content

Adhesive contains organic solvent, and the solvent steam needs to be removed after connection. During curing after piping, open both ends of pipe without enclosing and remove the solvent steam. During curing, the steam can be removed more effectively by ventilating inside piping using a ventilator (low-pressure specification) or washing inside piping by filling the water after the adhesive is hardened.

* Refer to [Explanation] 4.

[Explanation]

1 TS connection utilizes the swelling and elasticity of PVC by making the fitting socket tapered and using adhesive. Applying adhesive to the pipe and fitting would create a swelling layer of approximately 0.1 mm thickness on its surface as shown (Figure 1), and this layer makes the insertion of the pipe fluidly. After insertion, respective swelling layers of the pipe and fitting would interact each other, and the bonding surface would be unified.

Figure 1. Installation of TS Connection

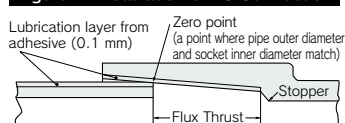
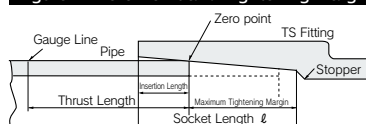

Figure 2. Zero Point and Tightening Margin



2 Based on a result of testing the relationship between the bonding margin length and pressure-resistant strength, it has been confirmed that practically acceptable water pressure strength can be secured by inserting approximately 1/3 of the fitting socket [ℓ] in addition to the insertion length without applying adhesive (zero point).

In regards to insertion margin in TS connection, it is ideal to insert TS fitting to the length of TS fitting gasket (stopper), but considering the tolerance of pipe and fitting dimensions, the length from zero point plus the bonding margin length shown in Table 2 to the stopper in Table 1 is sufficient enough, and inserting to the stopper of the fitting is not necessarily required.

However, if it cannot be inserted due to the adhesive being dried, etc., cut the connection part and reconnect again by using a new socket.

3 Inserting the pipe into the fitting before applying adhesive is to check the zero point. In this case, a combination of pipe and fitting that provide the insertion length of 1/3 to 2/3 ℓ from the pipe end surface (refer to Figure 2) is standard.

4 Be cautious of excessive adhesive (it may cause solvent cracking and damage). Caution is needed in low-temperature installation because solvent steam does not evaporate easily and tends to remain (it may cause solvent cracking and damage). During curing after piping, open both ends of pipe without enclosing and remove the solvent steam. During curing, the steam can be removed more effectively by ventilating inside piping using a ventilator (low-pressure specification) or washing inside piping by filling the water fully after the adhesive is hardened.

C-PVC Pipe Precautions

Design

Caution Working Pressure vs. Temperature

Working pressure differs by temperature and size. Use within an allowable range of relationship between maximum working pressure and temperature.

Caution Use for Hot Water Equipment

Avoid using them for instant heater. If the instant heater breaks down or has a malfunction, water or steam of abnormal temperature may flow and damage piping.

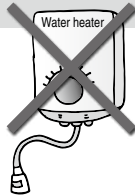

Caution Expansion/Contraction Treatment

Since AV C-PVC pipes have a higher heat expansion/contraction amount compared to steel pipes, an expansion/contraction treatment is important. Not performing an expansion/contraction treatment could cause damage. Provide a treatment to absorb expansion/contraction using AV expansion joints or elbows, etc.

Fitting Type	Size	Expansion/Contraction Absorbable Amount	Implementation example (absorbable expansion/contraction length)
AV Expansion Joint	20 mm to 100 mm	(Size 20 to 75 mm) 80 mm (Size 100 mm) 100 mm	<p>Use to absorb expansion/contraction at a straight part.</p> <ul style="list-style-type: none"> When length of the straight part is over 4 m <p>* In the case of temperature difference of 70°C or less.</p>
Elbow	13 mm to 200 mm	—	<p>Use to absorb expansion/contraction at a bending part.</p> <ul style="list-style-type: none"> When length of the straight part is 2 m or less When length of the straight part is 2 m up to 4 m

Caution Piping Under Concrete

Avoid using AV C-PVC pipes for burring under concrete or mortar.

Caution Multi-Branching Piping

Avoid using AV C-PVC pipes for multi-branching piping in bath, etc. and consider using lining steel pipes, etc.

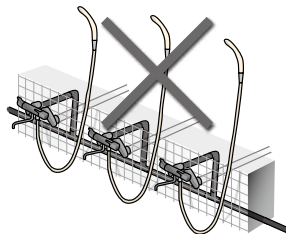

Caution Piping Support/Fixation

U-bands (with rubber seat) are recommended for fixing piping.

In the case of using U-bolts inevitably, provide a cushion such as rubber to prevent the pipes from touching the hardware directly. Cushion saddles and U-bolt rails are available as a cushion material. Please consider using them. Be cautious not to tighten nuts excessively. As a reference of nut tightening, ① tighten by hand and then rotate 1/2 using a spanner, etc., or ② tighten by setting torque wrench at 1N·m (10kgf·cm).

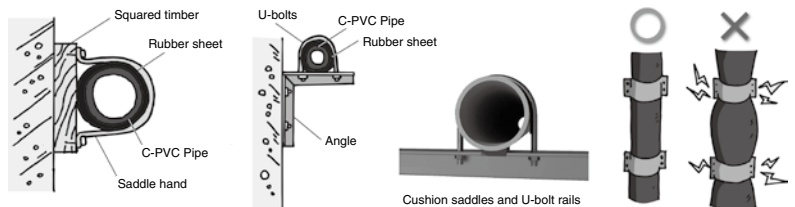

Caution Use for Industrial Kitchen Drainage Piping

Do not use them for piping draining from the steam convection oven, one of kitchen equipment. Detergents used in steam convection oven may contain ingredients that would give a negative influence (cracking, water leakage, etc.) to pipes and fittings.

Caution Piping to Architectural Structure

When using as piping for high-rise architectural structure such as buildings, consider not only the pump pressure but also the influence of the water head pressure (height) and use within a range of allowable relationship between maximum working temperature and pressure. If securing space for sufficient expansion/contraction measure is difficult, do not use AV C-PVC pipes and consider using other types of pipes (copper pipes, lining steel pipes, metal reinforced double laminated pipes, cross-linked polyethylene pipes, etc.)



* Vertical piping, buried piping, etc. are examples of places where implementing an expansion/contraction measure is difficult.

Caution Expansion/Contraction Absorption at Branch Area

For branching out from the main pipe side, the stress generated by expansion/contraction of the main pipe shall not be focused on the fitting of a branch point. For the purpose of branching method, basic items requiring an extra attention are as follows.

- Never execute direct branching and avoid having expansion/contraction of the main pipe give an impact to the branch pipe side by placing an elbow.
- Locate a branch point of the main pipe near a fix point as much as possible.

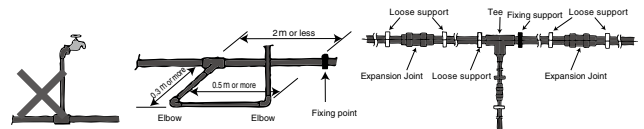

* Also refer to [Piping Support/Fixation].

Caution Use of Rubber Ring Joint

Fittings that use a rubber ring to tighten pipes cannot be used.



Warning Use for Chemical Solution Piping

In the case of using for chemical solution piping, please consult our nearest office whether or not it is usable in advance.



Precautions

⚠ Caution

If handled inappropriately, "it may cause death or serious injuries."

⚠ Warning

If handled inappropriately, "it may cause injuries or physical damage."

Installation

⚠ Caution Handling

Do not drop or throw during transportation and piping.

⚠ Warning Use of Adhesive

AV Cement is applicable to the "second class organic solvents, etc." in the Ordinance on Prevention of Organic Solvent Poisoning.

If indoor usage per hour exceeds the following allowable usage, "Ordinance on Prevention of Organic Solvent Poisoning" will be applied and qualification of "operation chief of organic solvents" will be required.

For details, please check with the local Labour Standard Inspection Office.

Allowable adhesive usage W (g/time) = 0.4 (g/m³ · time) × workplace cubic capacity (m³) Cubic capacity of room excludes a space at 4 m or higher from the floor surface. However, if the cubic capacity exceeds 150 m³, it shall be 150 m³. To prevent poisoning from organic solvents or fires, be cautious of ventilation and avoid flammables.

⚠ Warning Contact with Organic Compounds

Do not spray or apply an organic compound to cause a negative impact to the material of pipes and fittings such as acetone, thinner, creosote, pesticide and termite extermination agent. Even if the compounds above do not touch the pipes and fittings directly, they might damage the pipes and fittings buried shallow through penetration into the soil when if spilled on the ground.



* Exclude acetone and alcohol to be used for cleaning of pipes and fittings before connection.

⚠ Caution Use of Sealing Agent (Threaded End Connection Part)

Make sure to use seal tape for thread connection part. Using liquid seal or liquid gasket could cause stress cracking due to the organic solvent contained and lead to damage of fittings or water leakage.

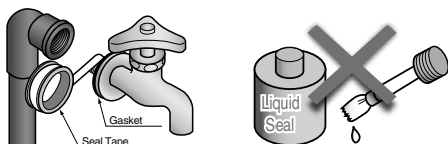

⚠ Warning Completion Inspection

Make sure to perform a completion inspection under water pressure after curing for a sufficient amount of time following the bonding work.

Do not perform an airtightness test by using air (compressed air or positive-pressure gas) as it is extremely dangerous.



⚠ Warning Selection of Adhesive

Make sure to use AV Adhesive No.88 (For Heat-Resistant Unplasticized Polyvinyl Chloride Pipe).

Try to apply adhesive thinly and evenly. Applying too much could cause solvent cracking, etc. and lead to water leakage.



⚠ Warning Storage of Adhesive

AV cement is applicable to "Class 1 Petroleums, Class 4 Hazardous Materials" of Article 2 of the Fire Services Act. Follow the laws and regulations and municipal ordinances for storage. Avoid flammables after use and store in a cool and dark place.

⚠ Caution Connection

Insert straight immediately after applying adhesive and hold it sufficiently to prevent "returning." When inserting, do not insert it forcibly by hammering and such.

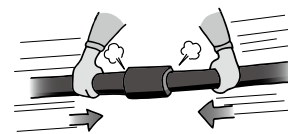

⚠ Warning Wear mask and gloves

Avoid contacting to the skin during handling, and wear organic gas mask or air-supplied respirator, protection gloves, protection glasses and others, as necessary. If contacted to the skin, rinse with soap and water immediately.



⚠ Warning Use of Sealing Agent (Wall/Floor Penetration Part)

A sealing agent is sometimes used to fill a gap when penetrating piping through wall and floor. Please check with the manufacturer of sealing agent in advance as some sealing agents contain plasticizer (phthalate ester, DOP, etc.) or organic solvent that could cause a negative influence and damage or cause water leakage from unplasticized polyvinyl chloride pipes and fittings.

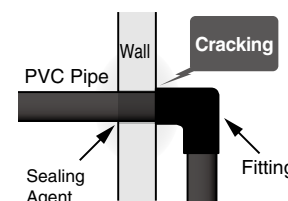

Piping Design Precautions

- Select an appropriate material in consideration of use conditions (fluid type, temperature, pressure, etc.) For details, please consult our nearest office in advance.
- Maximum working pressure is the pressure including the water hammer pressure. Do not use them exceeding the maximum working pressure.
- As maximum working pressure differs by size and temperature, design and use within the allowable range.
- Since they are made from plastic, heat expansion/contraction against temperature change is large compared to metals and heat stress is also generated. Therefore, perform piping support or expansion/construction treatment applicable to the use conditions and installation place.
- In the case of using under the positive-pressure gas, a dangerous condition is expected due to the particular reaction force of compressive fluid even when the value is the same as the water pressure. Therefore, implement a safety measure such as covering pipes with a protection material, etc. to protect the surrounding area before use.
- Do not joint with solvent adhesive or welding connection on differential plastic materials (It may cause damage)

Transportation Precautions

- Do not drag them as it could scratch pipes. Do not drag them as both ends of pipes are easily damaged.

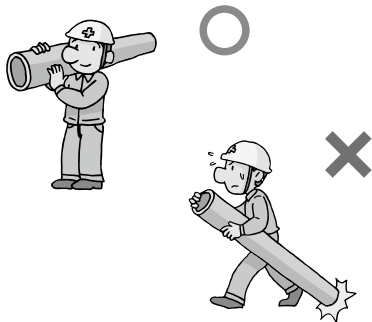

- Two people should handle a pipe with the size of 150 mm or more.

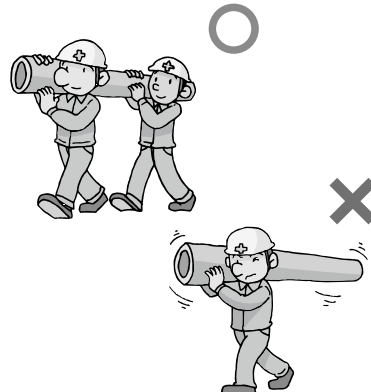

- Do not throw pipes from the truck platform.

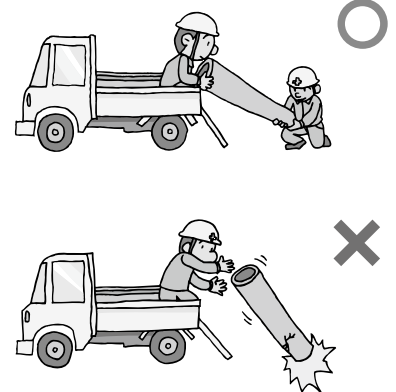

Storage Precautions

- When storing pipes and fittings outside, avoid direct sunlight and implement a measure such as placing a sheet in a way of avoiding heat accumulation.

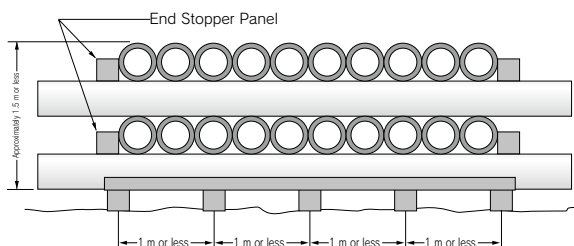

- Do not leave fittings in an enclosed condition (inside a vehicle in Summer, in an enclosed plastic bag, etc.) under a high temperature atmosphere.

Enclosed vehicle
(may deform due to heat)

Packed products in
an sealed condition

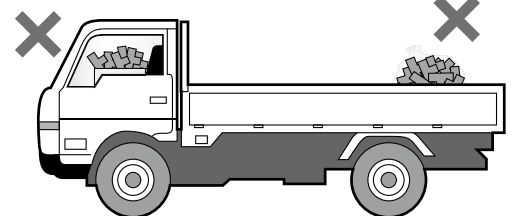

Installation

- Follow our installation procedure to fully exert the work safety and piping performance for installation.
- Make sure to use the specified AV cement for bonding AV PVC pipes.
- Be cautious of excessive adhesive (it may cause solvent cracking and damage). Caution is needed in low-temperature installation because solvent steam does not evaporate easily and tends to remain (it may cause solvent cracking and damage). During curing after piping, open both ends of pipe without enclosing and remove the solvent steam. During curing, it can be removed more effectively by ventilating inside piping using a ventilator (low-pressure specification) or washing inside piping by filling the water fully after the adhesive is hardened.
- Make sure to perform a completion inspection under water pressure. Do not perform an airtightness test by using air (compressed air or positive-pressure gas) as it is extremely dangerous.

Solvent Cracking (SC) Measure

SC (Solvent Cracking) is a type of stress cracking and specifically distinguished from the cracking phenomenon that occurs when solvent gives an impact inside PVC pipe. SC is caused by the existence of solvent (adhesive, preservative, etc.) It tends to occur more easily due to stress (heat stress, stress of TS connection part, bending, other external stress) and installation during low-temperature like in Winter (solvent tends to remain). When piping, implement a SC measure as explained as follows.

Item	Measure
Adhesive Usage	Apply adhesive compatible to the type of pipe thinly and evenly. Do not apply adhesive extending out from the insertion length on the pipe outer face. In particular, apply thinly and evenly to the inner face of fitting. The reference ratio of adhesive application is 7 to 3 for pipe and fitting.
Wiping of Adhesive	After bonding, make sure to wipe off the protruded adhesive with a cloth after inserting. During application, remove the adhesive spilled on the groove floor.
Opening of pipe on both ends	Fully open valve, air valve, blind flange, etc. for better ventilation and remove the solvent stream (do not enclose).
Utilization of Prefab Method	Prefabricate 2 to 4 pipes in advance, remove the solvent steam by natural ventilation and then connect the pipes.
Ventilation inside Piping	During curing after piping, open both ends of pipe without enclosing and remove the solvent steam (do not enclose). During curing, the steam can be removed more effectively by ventilating inside piping using a ventilator (low-pressure specification).
Washing inside Piping	During curing after piping, open both ends of pipe without enclosing and remove the solvent steam. It is more effective if you fill water all the way and wash after the adhesive is hardened (do not apply the water pressure at this time). Immediately perform this after leaving 30 minutes for the size of 50 mm or less and approximately 1 hour for the size of 65 mm or more.
Expansion Measure	Implement an expansion/contraction treatment to prevent the heat stress from rising due to temperature differences.
Support	When fixing piping, try to avoid using U-bolts as much as possible and use fixation bands with a wider width. In the case of using U-bolts, provide a cushion such as rubber to prevent piping from touching U-bolts. Be fully cautious not to tighten the fixation bands and U-bolts too much.

Adhesive Usage

Do not apply adhesive extending out from the gauge line.

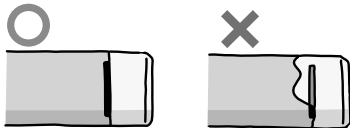

Apply thinly and evenly to the inner face of TS fitting gasket.

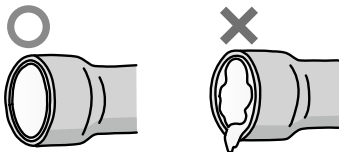

Wiping of Adhesive

Wipe off the protruded adhesive with a cloth after inserting.

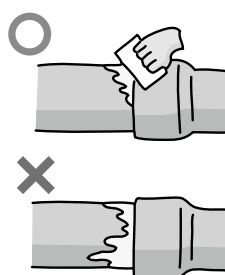

Support

Be cautious not to tighten saddle bands, U-bolts and U-bands too much.

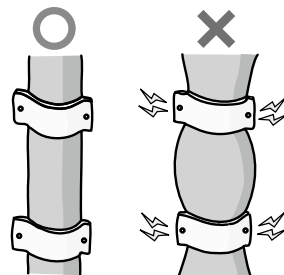

Expansion Measure

Provide expansion/contraction treatment to lower the heat stress.

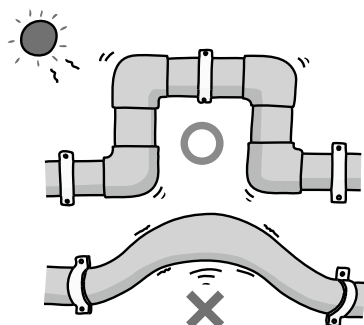

Removal of Solvent and Opening of Pipe on Both Ends

Ventilation

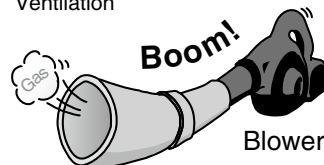

Washing with water



Opening of pipe on both ends

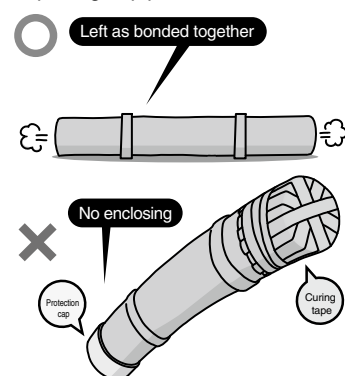

High Purity Pipe & Fittings

High Purity Resistance Polyvinyl Chloride Pipe (HP-PVC)	P.086
High Purity Resistance Polyvinyl Chloride Fittings (HP-PVC)	P.087
Flange	P.098
Prefab Joint	P.099
Multi-Joint	P.100
Joint Equipment	P.104
Technical Document	P.105



PRODUCT MODEL CODE LIST

High Purity

Type	Field	Material	Standard/Wall Thickness	Standard	Type	Size	Length
P	N	2	PP	J	N	***	04
P Pipe	N Standard	2 High Purity	PP Straight Pipe VP	J JIS	N Standard	013 13mm 300 300mm	04 4m

Straight Pipe (VP)

PRODUCT MODEL CODE

P N 2 PP J N Size 04

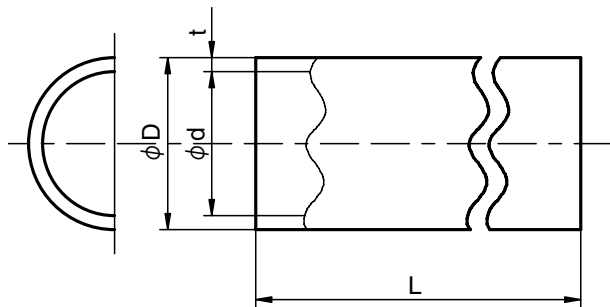
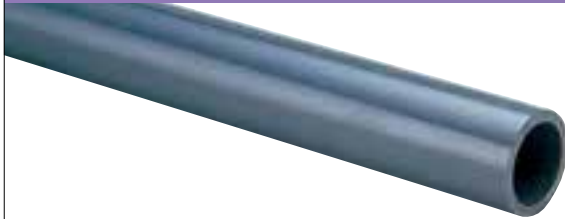

High Purity PVC Pipe Allowable Pressure by Temperature MPa (kgf/cm²)

Temperature	20°C	30°C	40°C	50°C
Size	1.0 {10.2}	0.9 {9.2}	0.7 {7.1}	0.3 {3.1}
13 – 300 mm				

Notes: This data is based on high purity water.

Dimensions Table

(Unit: mm)

Size	D			t		d	L
	Outer Diameter			Wall Thickness			
	Basic Dimension	Max/Min. Tolerance	Average Tolerance	Min.	Tolerance	Approximate Inner Diameter (Reference)	Length
13	18	±0.2	±0.2	2.2	+0.6	13	4000±10
16	22	±0.2	±0.2	2.7	+0.6	16	4000±10
20	26	±0.2	±0.2	2.7	+0.6	20	4000±10
25	32	±0.2	±0.2	3.1	+0.8	25	4000±10
30	38	±0.3	±0.2	3.1	+0.8	31	4000±10
40	48	±0.3	±0.2	3.5	+0.8	40	4000±10
50	60	±0.4	±0.2	4.1	+0.8	51	4000±10
65	76	±0.5	±0.3	4.1	+0.8	67	4000±10
75	89	±0.5	±0.3	5.5	+0.8	77	4000±10
100	114	±0.6	±0.4	6.6	+1.0	100	4000±10
125	140	±0.8	±0.5	7.0	+1.0	125	4000±10
150	165	±1.0	±0.5	8.9	+1.4	146	4000±10
200	216	±1.3	±0.7	10.3	+1.4	194	4000±10
250	267	±1.6	±0.9	12.7	+1.8	240	4000±10
300	318	±1.9	±1.0	15.1	+2.2	286	4000±10

Notes: 1. Length tolerance shall be ±10 mm.

2. Maximum/minimum outer dimensional tolerance is the allowed difference of measured outer diameter at any location.

3. Average outer dimensional tolerance is the allowed difference of arithmetic mean value of measured outer diameters in 2 directions perpendicular to each other at any location.

PRODUCT MODEL CODE LIST

High Purity

Type	Field	Material	Model	Standard	Type	Size
T	N	2	**	J	N	***
⋮	⋮	⋮	⋮	⋮	⋮	⋮
T TS Fitting	N Standard	2 High Purity	9L Elbow 4L 45° Elbow SO Socket TE Tee VS Valve Socket (Metal not contained) CP Cap FL Faucet Elbow (Metal not contained) FS Faucet Socket (Metal not contained)	J JIS	N Standard	013 13mm 150 150mm 016013 16×13mm 150125 150×125mm

High Purity Bend

Type	Field	Material	Model	Standard	Others	Size
B	N	2	45	V	N	***
⋮	⋮	⋮	⋮	⋮	⋮	⋮
B Bend	N None Color	2 High Purity	45 45° Bend	V AV	N Normal Color	040 40mm 150 150mm

High Purity Large-Size Bend

Type	Field	Material	Model	Standard	Others	Size
B	*	2	**	V	N	***
⋮	⋮	⋮	⋮	⋮	⋮	⋮
B Bend	N None Color F FRP (SU) G FRP (GU)	2 High Purity	45 45° Bend 90 90° Bend	V AV	N Normal Color	200 200mm 300 300mm

High Purity Large-Size Fitting

Type	Field	Material	Model	Standard	Others	Size
T	*	2	**	V	N	***
⋮	⋮	⋮	⋮	⋮	⋮	⋮
T TS Fitting	N None Color F FRP (SU) G FRP (GU)	2 High Purity	9L 90° Elbow SO Socket TE Tee	V AV	N Normal Color	200 200mm 300 300mm 200075 200×75mm 300250 300×250mm

AVTS Fitting Socket Common Dimensions

Size 13 – 150 mm

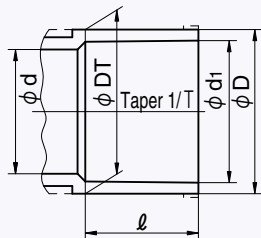

High Purity PVC Fitting Allowable Pressure by Temperature MPa (kgf/cm²)

Temperature	20°C	30°C	40°C	50°C
Size (mm)				
13 – 150 mm	1.0	0.9	0.7	0.3

Notes: 1. This data is based on high purity water.

Dimensions Table

(Unit: mm)

Size	d ₁	d ₁ Tolerance	ℓ	1/T	D	DT	D and DT Tolerance	d (Min.)	Applicable Pipe Outer Diameter
13	18.40	±0.20	26	1/30	24	24.0	-0.6	13	18
16	22.40	±0.20	30	1/34	29	29.0	-0.7	16	22
20	26.45	±0.20	35	1/34	33	33.0	-0.8	20	26
25	32.55	±0.25	40	1/34	40	40.0	-1.0	25	32
30	38.60	±0.25	44	1/34	46	46.0	-1.0	31	38
40	48.70	±0.30	55	1/37	57	57.0	-1.2	40	48
50	60.80	±0.30	63	1/37	70	70.0	-1.5	51	60
* 65	76.60	±0.30	61	1/48	87	88.5	-1.5	67	76
75	89.60	±0.30	64	1/49	102	104.5	-1.5	77	89
100	114.70	±0.30	84	1/56	130	133.5	-1.8	100	114
* 125	140.85	±0.35	104	1/58	157	161.0	-1.8	125	140
150	166.00	±0.40	132	1/63	186	190.0	-2.0	146	165

Notes: 1. ℓ tolerance shall be $^{+4}_{-0.5}$ mm.

2. * The marked ones conform to the AV standard and the JPPFA standard.

High Purity PVC Pipe & Fittings Standard Table

Product Name Size (mm)	Pipe	L	S	T	45L	TS Flange	Q Flange	90° Bend	FL	VS	FS	C	Prefab Joint
13	○	○	○	○	—	○	—	—	○	○	○	○	○
16	○	○	○	○	—	○	○	—	○	○	○	○	○
20	○	○	○	○	○	○	○	—	○	○	○	○	○
25	○	○	○	○	○	○	○	—	○	○	○	○	○
30	○	○	○	○	—	○	○	—	—	○	—	—	○
40	○	○	○	○	○	○	○	—	—	○	—	○	○
50	○	○	○	○	○	○	○	—	—	○	—	○	○
65	○	○	○	○	○	○	○	—	—	○	—	○	○
75	○	○	○	○	○	○	○	—	—	○	—	○	○
100	○	○	○	○	○	○	○	—	—	○	—	○	○
125	○	○	○	○	○	○	○	—	—	—	—	—	—
150	○	○	○	○	○	○	○	—	—	—	—	—	—
200	○	○	○	○	○	○	—	○	—	—	—	—	—
250	○	○	○	○	○	○	—	○	—	—	—	—	—
300	○	○	○	○	○	○	—	○	—	—	—	—	—

High Purity PVC Reducer Fitting Standard Table

Product Name Size (mm)	T	S	Product Name Size (mm)	T	S	Product Name Size (mm)	T	S
16x13	○	—	40x30	○	○	100x 75	○	○
20x13	○	○	50x13	○	—	125x 75	○	—
20x16	○	○	50x16	○	—	125x100	○	—
25x13	○	○	50x20	○	○	150x 75	○	—
25x16	○	○	50x25	○	○	150x100	○	—
25x20	○	○	50x30	○	—	150x125	○	○
30x13	○*	○*	50x40	○	○	200x 75	○	—
30x16	○	—	65x40	○	—	200x100	○	—
30x20	○	○*	65x50	○	○	200x150	○	○
30x25	○	○	75x25	○	—	250x 75	○	—
40x13	○	—	75x40	○	—	250x100	○	—
40x16	○*	—	75x50	○	○	250x200	○	○
40x20	○	○	75x65	—	○	300x250	—	○
40x25	○	○	100x50	○	—			

* Cannot perform welding connection.

High Purity PVC Fitting Allowable Pressure by Temperature

Temperature Size (mm)	20°C	30°C	40°C	50°C
13 – 150	1.0 {10.2}	0.9 {9.2}	0.7 {7.1}	0.3 {3.1}
200	0.75 {7.7}	0.6 {6.1}	0.5 {5.1}	0.25 {2.6}
250	0.6 {6.1}	0.5 {5.1}	0.4 {4.1}	0.2 {2.0}
300	0.4 {4.1}	0.4 {4.1}	0.3 {3.1}	0.1 {1.1}

Elbow

Abbreviation: **L**

PRODUCT
MODEL CODE

TS ▶ T N 2 9L J N Size



TS **High Purity PVC**

Size 13 – 50mm

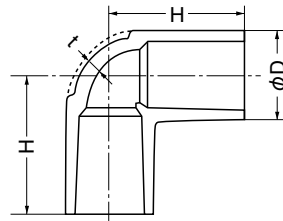

Size 65 – 150mm

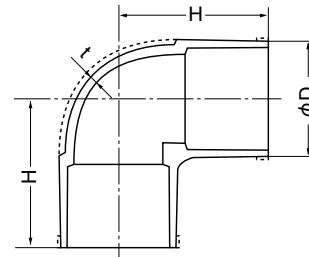

Maximum Working Pressure (20°C)

TS 1.0MPa

Dimensions Table

(Unit: mm)

Size	TS	D	t	H
13	○	24.0	3.0	36
16	○	29.0	3.5	43
20	○	33.0	3.5	50
25	○	40.0	4.0	58
30	○	46.0	4.0	65
40	○	57.0	4.5	82

Size	TS	D	t	H
50	○	70.0	5.0	96
65	●	87.0	6.6	110
75	●	102.0	8.0	120
100	●	130.0	10.0	153
125	●	157.0	11.0	188
150	●	186.0	13.0	230

Notes: 1. H tolerance shall be ± 0.5 mm. 2. ● conform to the JPPFA standard. 3. ○ are accordance with JIS K6743.

45° Elbow

Abbreviation: **45L**

PRODUCT
MODEL CODE

TS ▶ P N 2 4L J N Size



TS **High Purity PVC**

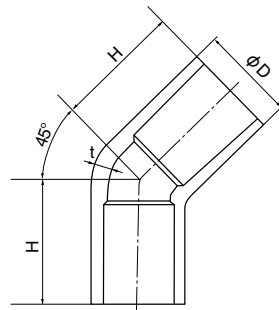

Maximum Working Pressure (20°C)

TS 1.0MPa

Dimensions Table

(Unit: mm)

Size	TS	D	t	H
20	○	33.0	3.5	44
25	○	40.0	4.0	51

Notes: 1. H tolerance shall be ± 0.5 mm.
2. ○ are accordance with JIS K6743.

45° Bend

PRODUCT
MODEL CODE

TS ▶ B N 2 45 V N Size



TS **High Purity PVC**

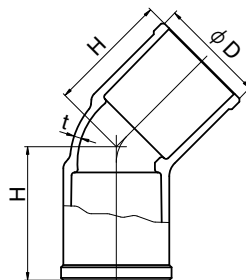

Maximum Working Pressure (20°C)

TS 1.0MPa

Dimensions Table

(Unit: mm)

Size	TS	D	t	H
40	○	57	4.5	69
50	○	70	5	80
65	○	87	6.6	81
75	□	101	6	97
100	□	129	7.3	122
125	□	156	7.7	149
150	□	185	10	184

Notes: 1. □ conform to the AV standard.
2. ○ are accordance with JIS K6743.

Socket

Abbreviation: **S**

PRODUCT MODEL CODE

TS ▶ T N 2 SO J N Size



TS **High Purity PVC**

Size 13 – 50mm

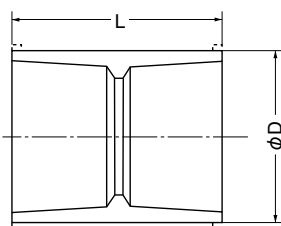

Size 65 – 150mm

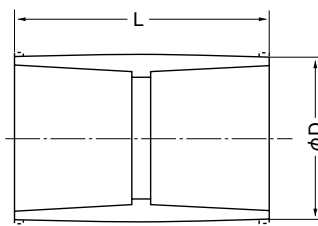

Maximum Working Pressure (20°C)

TS 1.0MPa

Dimensions Table

(Unit: mm)

Size	TS	D	L	Size	TS	D	L
13	○	24.0	57	50	○	70.0	133
16	○	29.0	67	65	●	87.0	145
20	○	33.0	77	75	○	102.0	155
25	○	40.0	87	100	○	130.0	200
30	○	46.0	95	125	●	157.0	240
40	○	57.0	117	150	○	186.0	300

Notes :1. L tolerance shall be ±4.0 mm. 2. ● conform to the JPPFA standard. 3. ○ are accordance with JIS K6743.

Reducing Socket

Abbreviation: **RS**

PRODUCT MODEL CODE

TS ▶ T N 2 SO J N Size



TS **High Purity PVC**

Details of A

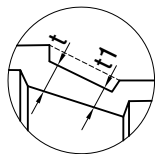

Size 13 – 50mm

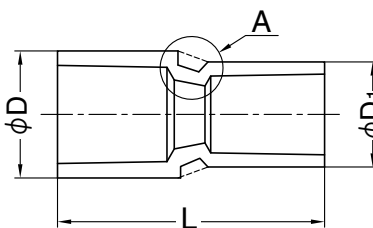

Size 65 – 150mm

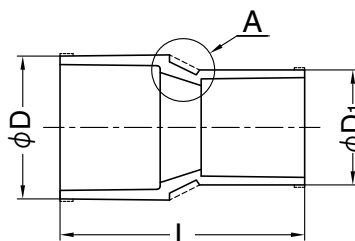

Maximum Working Pressure (20°C)

TS 1.0MPa

Dimensions Table

(Unit: mm)

Size	TS	D	t	D ₁	t ₁	L	Size	TS	D	t	D ₁	t ₁	L
20×13	○	33.0	3.5	24.0	3.0	68	50×20	●	70.0	5.0	33.0	3.5	116
20×16	○	33.0	3.5	29.0	3.5	71	50×25	●	70.0	5.0	40.0	4.0	140
25×13	○	40.0	4.0	24.0	3.0	86	50×40	○	70.0	5.0	57.0	4.5	136
25×16	○	40.0	4.0	29.0	3.5	85	65×50	●	87.0	6.6	70.0	5.0	149
25×20	○	40.0	4.0	33.0	3.5	84	75×50	○	102.0	8.0	70.0	5.0	165
※ 30×13	□	48.2	—	28.2	—	73.2	75×65	●	102.0	8.0	87.0	6.6	159
※ 30×20	□	48.2	—	36.2	—	83	100×75	○	130.0	10.0	102.0	8.0	190
30×25	○	46.0	4.0	40.0	4.0	93	125×100	●	157.0	11.0	130.0	10.0	229
40×20	●	57.0	4.5	33.0	3.5	113	150×125	○	186.0	13.0	157.0	11.0	272
40×25	○	57.0	4.5	40.0	4.0	114							
40×30	○	57.0	4.5	46.0	4.0	114							

Notes :1. L tolerance shall be ±4.0 mm. 2. ● conform to the JPPFA standard. 3. □ conform to the AV standard.

4. ○ are accordance with JIS K6743. 5. ※ conform that's not available to welding connection.

Tee

Abbreviation: **T**

PRODUCT
MODEL CODE

TS ▶ T N 2 TE J N Size



TS **High Purity PVC**

Size 13 – 50mm

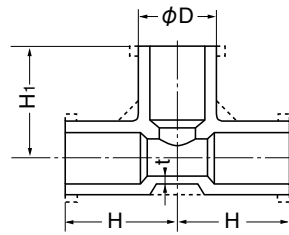

Size 65 – 150mm

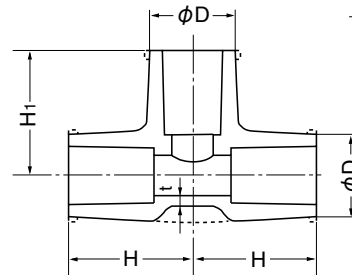

Maximum Working Pressure (20°C)

TS 1.0MPa

Dimensions Table

Size	TS	D	t	H	H1
13	○	24.0	3.0	36	36
16	○	29.0	3.5	43	43
20	○	33.0	3.5	50	50
25	○	40.0	4.0	58	58
30	○	46.0	4.0	65	65
40	○	57.0	4.5	82	82

Size	TS	D	t	H	H1
50	○	70.0	5.0	96	96
65	●	87.0	6.6	110	110
75	○	102.0	8.0	120	120
100	○	130.0	10.0	152	152
125	●	157.0	11.0	187	187
150	○	186.0	13.0	230	230

(Unit: mm)

Notes : 1. H tolerance shall be ± 0.5 mm. 2. ● conform to the JPPFA standard. 3. ○ are accordance with JIS K6743.

Reducing Tee

Abbreviation: **T**

PRODUCT
MODEL CODE

TS ▶ T N 2 TE J N Size



TS **High Purity PVC**

Size 13 – 50mm

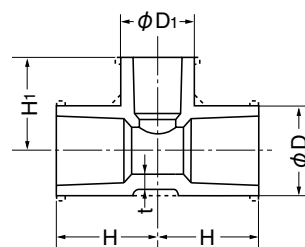

Size 65 – 150mm

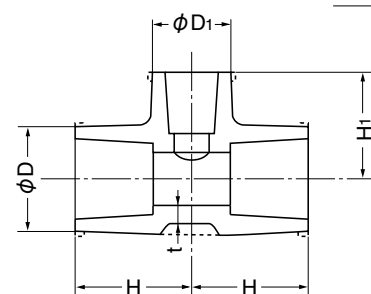

Maximum Working Pressure (20°C)

TS 1.0MPa

Dimensions Table

Size	TS	D	t	H	D ₁	H ₁
16×13	○	29.0	3.5	41	24.0	38.0
20×13	○	33.0	3.5	46	24.0	40.0
20×16	○	33.0	3.5	48	29.0	45.0
25×13	○	40.0	4.0	51	24.0	43.0
25×16	○	40.0	4.0	53	29.0	48.0
25×20	○	40.0	4.0	55	33.0	53.0
※ 30×13	□	48.2	6.5	54.7	28.2	44.0
30×16	○	46.0	4.0	57	29.0	51.0
30×20	○	46.0	4.0	59	33.0	56.0
30×25	○	46.0	4.0	62	40.0	61.0

Size	TS	D	t	H	D ₁	H ₁
40×13	○	57.0	4.5	66	24.0	52
※ 40×16	□	58.4	5.2	62.4	30.9	52.5
40×20	○	57.0	4.5	70	33.0	62
40×25	○	57.0	4.5	73	40.0	67
40×30	○	57.0	4.5	76	46.0	71
50×13	○	70.0	5.0	74	24.0	58
50×16	○	70.0	5.0	76	29.0	63
50×20	○	70.0	5.0	78	33.0	68
50×25	○	70.0	5.0	81	40.0	73
50×30	○	70.0	5.0	84	46.0	77
50×40	○	70.0	5.0	90	57.0	88

(Unit: mm)

Dimensions Table

Size	TS	D	t	H	D ₁	H ₁
65×40	●	87.0	6.6	100	57.0	95
65×50	●	87.0	6.6	101	70.0	104
75×25	○	102.0	8.0	93	40.0	88
75×40	○	102.0	8.0	100	57.0	102
75×50	○	102.0	8.0	105	70.0	110

Size	TS	D	t	H	D ₁	H ₁
100×50	○	130.0	10.0	125	70.0	122
100×75	○	130.0	10.0	140	102.0	132
125×75	●	157.0	11.0	160	102.0	147
125×100	●	157.0	11.0	173	130.0	167
150×75	○	186.0	13.0	195	102.0	158
150×100	○	186.0	13.0	208	130.0	182
150×125	●	186.0	13.0	217	157.0	201

(Unit: mm)

Notes : 1. H and H1 tolerance shall be ± 0.5 mm. 2. ● conform to the JPPFA standard. 3. □ conform to the AV standard.

4. ○ are accordance with JIS K6743. 5. ※ conform that's not available to welding connection.

Faucet Elbow

Abbreviation: **FL**

PRODUCT MODEL CODE

TS ▶ T N 2 FL J N Size



TS **High Purity PVC**

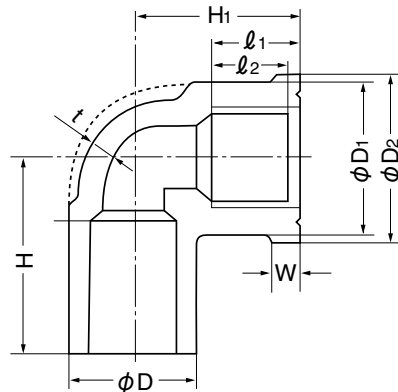

Maximum Working Pressure (20°C)

TS 1.0MPa

<Use Precautions>

- * Use both seal tape and gasket for connection of threaded ends.
- * Do not use them for connecting steel pipe and PVC pipe.
- * Fix the area around an elbow using a retainer.

Dimensions Table

(Unit: mm)

Size	TS	D	t	D ₁	D ₂	l ₁	l ₂	W	H	H ₁	Female Thread Size
13	□	24.0	3.0	30	34	17	14	4	38	29	Rp1/2
16	□	29.0	3.5	30	34	17	14	4	43	32	Rp1/2
20	□	33.0	3.5	37	42	19	16	4	51	36	Rp3/4
25	□	40.0	4.0	46	52	21	18	5	59	40	Rp1

Notes: 1. Threaded end shall be parallel female thread of JIS B 0203 (taper threaded end for pipes). 2. H tolerance shall be $^{+5}_{-1}$ mm. 3. H1 tolerance shall be $^{+5}_{-2}$ mm. 4. □ conform to the AV standard. 5. l₂ tolerance shall be ±1 mm.

Faucet Socket

Abbreviation: **FS**

PRODUCT MODEL CODE

TS ▶ T N 2 FS J N Size



TS **High Purity PVC**

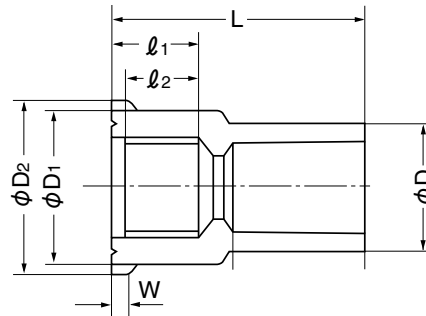

Maximum Working Pressure (20°C)

TS 1.0MPa

<Use Precautions>

- * Use both seal tape and gasket for connection of threaded ends.
- * Do not use them for connecting steel pipe and PVC pipe.

Dimensions Table

(Unit: mm)

Size	TS	D	D ₁	D ₂	l ₁	l ₂	W	L	Female Thread Size
13	□	24.0	30	34	17	14	4	47	Rp1/2
16	□	29.0	30	34	17	14	4	52	Rp1/2
20	□	33.0	37	42	19	16	4	59	Rp3/4
25	□	40.0	46	52	21	18	5	68	Rp1

- Notes: 1. Threaded end shall be parallel female thread of JIS B 0203 (taper threaded end for pipes).
 2. L tolerance shall be $^{+5}_{-1}$ mm.
 3. l₂ tolerance shall be ± 1 mm.
 4. □ conform to the AV standard.

Valve Socket

Abbreviation: **VS**

PRODUCT MODEL CODE

TS ▶ T N 2 VS J N Size



TS **High Purity PVC**

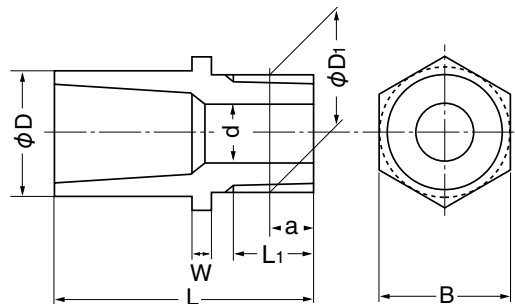

Maximum Working Pressure (20°C)

TS 1.0MPa

<Use Precautions>

- * Avoid screwing in and removing repeatedly.
- * Do not connect threaded parts using seal tape.
- * Do not use them for connecting with steel pipe.
- * Do not use them for buried pipe.
- * Do not use them for the area where an external force such as bending and vibration is applied.

Dimensions Table

(Unit: mm)

Size	TS	D	d	Thread Nominal	Basic Diameter Outer Diameter D ₁	Thread Number of Threads/Inch	Basic Diameter Position a	L ₁ (Min.)	W	L	B
13	○	24.0	13	R1/2	20.955	14	8.16	13.16	6	50	24
16	○	29.0	13	R1/2	20.955	14	8.16	13.16	6	54	29
20	○	33.0	18	R3/4	26.441	14	9.53	14.53	8	64	33
25	○	40.0	23	R1	33.249	11	10.39	16.79	8	71	40
30	○	46.0	31	R1 1/4	41.910	11	12.70	19.10	10	80	46
40	○	57.0	37	R1 1/2	47.803	11	12.70	19.10	10	92	57
50	○	70.0	48	R2	59.614	11	15.88	23.38	12	106	70
65	□	87.0	62	R2 1/2	75.184	11	17.46	30	15	118	87
75	□	102.0	72	R3	87.884	11	20.64	34	16	127	102
100	□	130.0	96	R4	113.030	11	25.40	40	18	157	130

- Notes: 1. Threaded end shall conform to taper male threaded end of JIS B0203 (taper threaded end for pipes).
 2. L tolerance shall be $^{+5}_{-2}$ mm.
 3. ○ are accordance with JIS K6743.
 4. □ conform to the AV standard.
 5. B tolerance shall conform to D tolerance.

Cap

Abbreviation: **C**

PRODUCT MODEL CODE

TS ▶ T N 2 CP J N Size



TS **High Purity PVC**

Size 13 – 50 mm

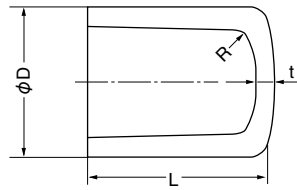

Size 65 – 150 mm

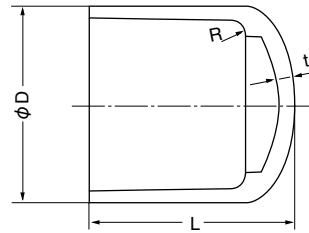

Maximum Working Pressure (20°C)

TS 1.0MPa

Dimensions Table

(Unit: mm)

Size	TS	D	t	L
13	○	24.0	3.0	29.0
16	○	29.0	3.5	33.5
20	○	33.0	3.5	38.5
25	○	40.0	4.0	44.0
40	○	57.0	4.5	59.5

Size	TS	D	t	L
50	○	70.0	5.0	68.0
65	●	87.0	6.6	96.0
75	○	102.0	8.0	105.0
100	●	130.0	10.0	138.0

Notes: 1. L tolerance shall be $^{+5}$ mm. 2. ● conform to the AV standard and the JPPFA standard.
3. R tolerance shall be 1 to 5 mm. 4. ○ are accordance with JIS K6743.

AV45° Bend

PRODUCT MODEL CODE

TS ▶ B N 2 45 V N Size
FRP (SU) ▶ B F 2 45 V N Size
FRP (GU) ▶ B G 2 45 V N Size



TS **High Purity PVC**



FRP Reinforcement Product (SU, GU)

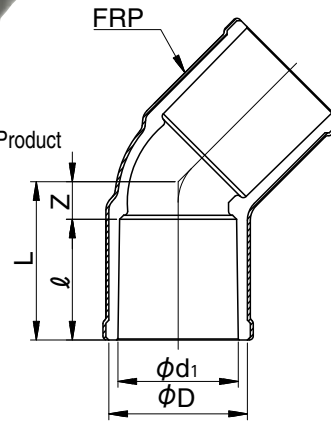
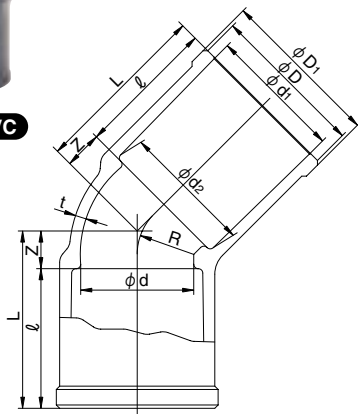

Maximum Working Pressure (20°C)

200mm TS 0.75MPa
250mm TS 0.6MPa
300mm TS 0.4MPa
FRP Reinforcement Product 1.0MPa

Dimensions Table

(Unit: mm)

Size	TS	FRP	d ₁	d ₂	ℓ	D (Min.)	D ₁ (Reference)	d	t (Min.)	Z	L	R
200	□	□	217.00	214.10	145	240	244	196	15	48	193	98
250	□	□	268.20	265.00	155	293	298	247	16	58	213	123.5
300	□	□	318.70	315.88	155	337	341	298	10	70	225	149

Notes: 1. □ conform to the AV standard.

Elbow (L)

PRODUCT MODEL CODE	TS	T	N	2	9L	V	N	Size
	FRP (SU)	T	F	2	9L	V	N	Size
	FRP (GU)	T	G	2	9L	V	N	Size



TS High Purity PVC

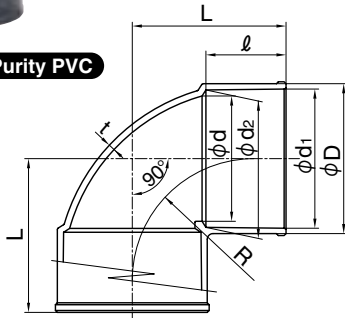

FRP Reinforcement Product (SU, GU)

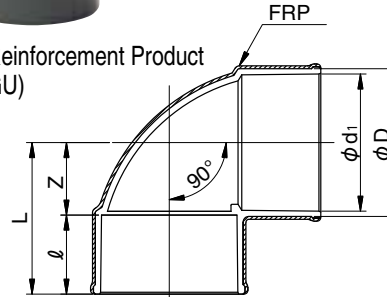

Maximum Working Pressure (20°C)	
200mm TS	0.75MPa
250mm TS	0.6MPa
300mm TS	0.4MPa
FRP Reinforcement Product	1.0MPa

Dimensions Table

(Unit: mm)

Size	TS	FRP	d ₁	d ₂	l	D	d	t	L	R
200	<input type="checkbox"/>	<input type="checkbox"/>	217.0	214.1	145	240	201	15	265	190
250	<input type="checkbox"/>	<input type="checkbox"/>	268.2	265.0	155	295	247	16	311	235
300	<input type="checkbox"/>	<input type="checkbox"/>	319.6	315.5	175	347	298	18	350	170

Notes: 1. conform to the AV standard.

Socket

PRODUCT MODEL CODE	TS	T	N	2	SO	V	N	Size
	FRP (SU)	T	F	2	SO	V	N	Size
	FRP (GU)	T	G	2	SO	V	N	Size



TS High Purity PVC

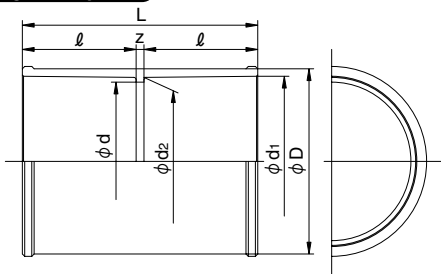

FRP Reinforcement Product (SU, GU)

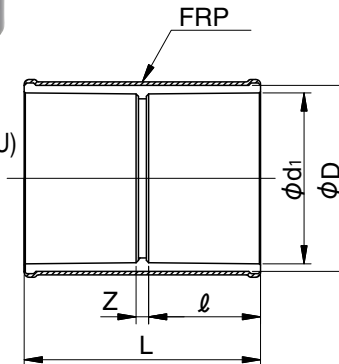

Maximum Working Pressure (20°C)	
200mm TS	0.75MPa
250mm TS	0.6MPa
300mm TS	0.4MPa
FRP Reinforcement Product	1.0MPa

Dimensions Table

(Unit: mm)

Size	TS	FRP	d ₁	d ₂	l	D	d	Z	L
200	<input type="checkbox"/>	<input type="checkbox"/>	217.0	214.1	145	238	202	15	305
250	<input type="checkbox"/>	<input type="checkbox"/>	268.2	265.0	155	295	247	42	352
300	<input type="checkbox"/>	<input type="checkbox"/>	319.6	315.5	175	336	298	10	360

Notes: 1. conform to the AV standard.

Reducing Socket

PRODUCT MODEL CODE	TS	T	N	2	SO	V	N	Size
	FRP (SU)	T	F	2	SO	V	N	Size
	FRP (GU)	T	G	2	SO	V	N	Size



TS High Purity PVC

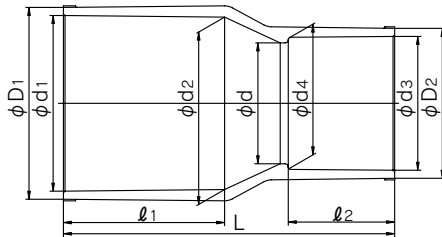

FRP Reinforcement Product (SU, GU)

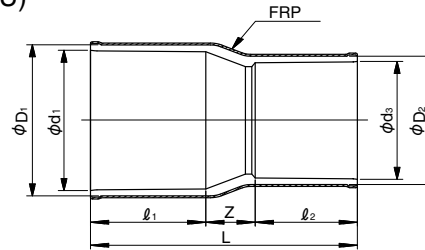

Maximum Working Pressure (20°C)	
200mm TS	0.75MPa
250mm TS	0.6MPa
300mm TS	0.4MPa
FRP Reinforcement Product	1.0MPa

Dimensions Table

(Unit: mm)

Size	TS	FRP	d_1	d_2	l_1	d_3	d_4	l_2	D_1	D_2	d	L
200×150	<input type="checkbox"/>	<input type="checkbox"/>	217.0	214.1	145	166.0	163.9	132	240	188	146	356
250×200	<input type="checkbox"/>	<input type="checkbox"/>	268.2	265.0	155	217.0	214.1	145	292	240	194	380
300×250	<input type="checkbox"/>	<input type="checkbox"/>	319.6	315.5	175	268.2	265.0	155	347	295	247	405

Notes: 1. conform to the AV standard.

Tee

PRODUCT MODEL CODE	TS	T	N	2	TE	V	N	Size
	FRP (SU)	T	F	2	TE	V	N	Size
	FRP (GU)	T	G	2	TE	V	N	Size



TS High Purity PVC

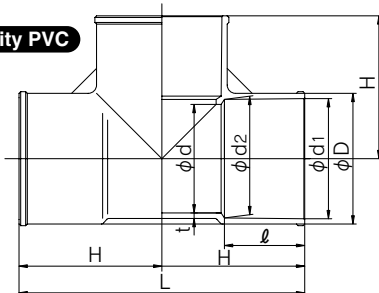

FRP Reinforcement Product (SU, GU)

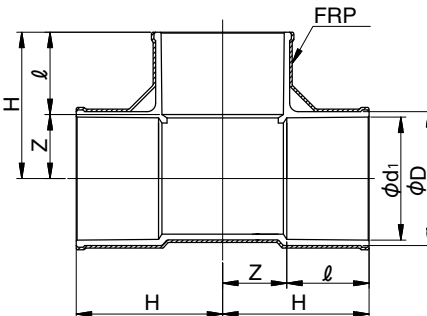

Maximum Working Pressure (20°C)	
200mm TS	0.75MPa
250mm TS	0.6MPa
300mm TS	0.4MPa
FRP Reinforcement Product	1.0MPa

Dimensions Table

(Unit: mm)

Size	TS	FRP	d_1	d_2	l	D	d	t	L	H
200	<input type="checkbox"/>	<input type="checkbox"/>	217.0	214.1	145	240	196	15	532	266
250	<input type="checkbox"/>	<input type="checkbox"/>	268.2	265.0	155	295	247	16	662	331
300	<input type="checkbox"/>	<input type="checkbox"/>	319.6	315.5	175	337	298	10	680	340

Notes: 1. conform to the AV standard.

Reducing Tee

PRODUCT MODEL CODE	TS	T	N	2	TE	V	N	Size
	FRP (SU)	T	F	2	TE	V	N	Size
	FRP (GU)	T	G	2	TE	V	N	Size



TS High Purity PVC

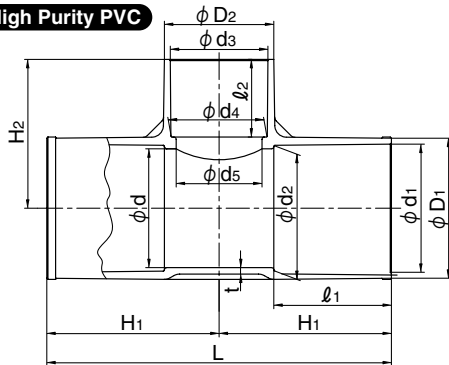

FRP Reinforcement Product (SU, GU)

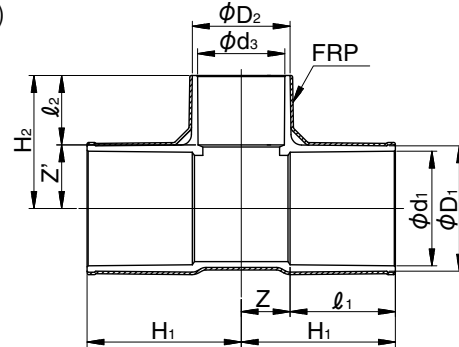

Maximum Working Pressure (20°C)

200mm TS	0.75MPa
250mm TS	0.6MPa
300mm TS	0.4MPa
FRP Reinforcement Product	1.0MPa

Dimensions Table

(Unit: mm)

Size	TS	FRP	d ₁	d ₂	l ₁	d ₃	d ₄	l ₂	D ₁	D ₂	d	d ₅	t	L	H ₁	H ₂
200×75	<input type="checkbox"/>	<input type="checkbox"/>	217.0	214.1	145	89.6	88.29	64	240	107.2	199	77	15	402	201	180
200×100	<input type="checkbox"/>	<input type="checkbox"/>	217.0	214.1	145	114.7	113.20	84	240	130	199	100	15	430	215	200
200×150	<input type="checkbox"/>	<input type="checkbox"/>	217.0	214.1	145	166.0	163.91	132	240	188	199	146	15	476	238	253
250×75	<input type="checkbox"/>	<input type="checkbox"/>	268.2	265.0	155	89.6	88.29	64	295	108	247	77	16	452	226	210
250×100	<input type="checkbox"/>	<input type="checkbox"/>	268.2	265.0	155	114.7	113.20	84	295	136	247	100	16	492	246	225
250×200	<input type="checkbox"/>	<input type="checkbox"/>	268.2	265.0	155	217.0	214.10	145	295	245	247	194	16	608	304	310
300×75	<input type="checkbox"/>	<input type="checkbox"/>	320.7	314.7	300	89.60	88.29	64	343	102	298	77	17	722	361	236

Notes: 1. conform to the AV standard.

PRODUCT MODEL CODE LIST

Type	Field	Model	Material	Standard	Size
F	N	*	2	1	***
⋮	⋮	⋮	⋮	⋮	⋮
F Flange	N None Color	T TS Flange Q Blind Flange	2 High Purity PVC	1 JIS10K	013 13mm I 300 300mm

TS Flange

PRODUCT MODEL CODE

JIS 10K ▶ F N T 2 1 Size

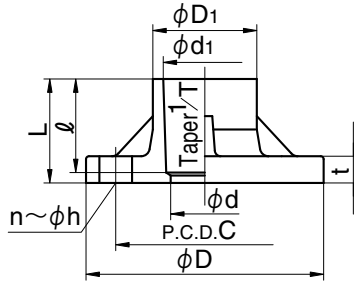

Maximum Working Pressure (Normal Temperature)

JIS 10K 13 – 300 mm 1.0MPa

Dimensions Table

(Unit: mm)

Size		d	JIS 10K				d ₁	Taper 1/T	D ₁	t	$\phi \begin{smallmatrix} +4.0 \\ -0.5 \end{smallmatrix}$	L
mm	inch		D	C	n	h						
13	3/8	15	90	65	4	15	18.40±0.20	1/30	25.5	14	26	30.0
15	1/2	18	95	70	4	15	22.40±0.20	1/34	31.0	14	30	35.0
20	3/4	22	100	75	4	15	26.45±0.20	1/34	35.0	15	35	40.0
25	1	25	125	90	4	19	32.55±0.25	1/34	42.5	15	40	46.0
32	1 1/4	30	135	100	4	19	38.60±0.25	1/34	48.5	16	44	50.5
40	1 1/2	41	140	105	4	19	48.70±0.30	1/37	60.5	16	55	61.5
50	2	52	155	120	4	19	60.80±0.30	1/37	73.0	20	63	71.0
65	2 1/2	67	175	140	4	19	76.60±0.30	1/48	90.0	22	61	70.0
80 (75)	3	78	185	150	8	19	89.60±0.30	1/49	105.0	22	64	73.0
100	4	100	210	175	8	19	114.70±0.30	1/56	131.0	22	84	93.0
125	5	125	250	210	8	23	140.85±0.35	1/58	158.0	24	104	114.0
150	6	146	280	240	8	23	166.00±0.40	1/63	185.0	26	132	142.0
200	8	196	330	290	12	23	217.00±1.00	1/50	238.0	28	145	156.0
250	10	247	400	355	12	25	268.20±1.00	1/55	300.0	30	155	167.0
300	12	298	445	400	16	25	318.00±1.80	1/55	341.0	30	155	167.0

Blind Flange

PRODUCT MODEL CODE

JIS 10K ▶ F N Q 2 1 Size

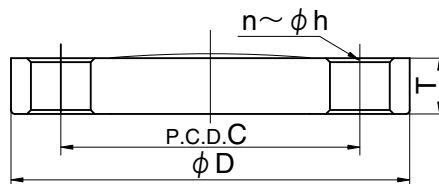
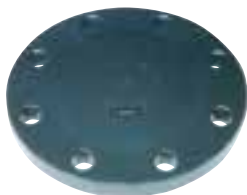

Maximum Working Pressure (Normal Temperature)

JIS 10K 13 – 150mm 1.0MPa

Notes: This is for closing the pipe end.

Dimensions Table

(Unit: mm)

Size		d	JIS 10K				t
mm	inch		D	C	n	h	
15	1/2	18	90	70	4	15	12
20	3/4	22	100	75	4	15	14
25	1	25	125	90	4	19	14
32	1 1/4	30	135	100	4	19	16
40	1 1/2	41	140	105	4	19	16
50	2	52	155	120	4	19	16
65	2 1/2	67	175	140	4	19	18
80 (75)	3	78	185	150	8	19	18
100	4	100	210	175	8	19	18
125	5	125	250	210	8	23	20
150	6	146	280	240	8	23	22

PRODUCT MODEL CODE LIST

Model	Material	Rubber	Connection	Standard	Size
JPF	2	*	*	J	***
JPF Prefab Joint	2 High Purity PVC	E EPDM V FKM F Viflon®F/FKM-F C Viflon®C/FKM-C	T Socket N Threaded	J JIS	013 13mm I 100 100mm

Prefab Joint



Features

- Installation is extremely simple and it can be done quickly and certainly. (Especially necessary for sleeve bonding/screw-in piping)
- Installable on piping where suitable and easy cleaning inside pipes.
- After installing piping, the valve parts can be removed by just loosening the union nut. It is suitable for pipelines requiring regular removals such as temporary piping and slurry piping.

Prefab Joint Standard Table

Body Material	Connection Method	13	16	20	25	30	40	50	65	75	100
U-PVC	Socket End	○	○	○	○	○	○	○	○	○	○
	Threaded End	○	○	○	○	○	○	○	—	—	—

Parts Table

No.	Description	pcs.	Material
①	Body	1	U-PVC
②	End Connector	1	U-PVC
③	Union Nut	1	U-PVC
④	O-Ring	1	EPDM, FKM, Viflon®F/FKM-F, Viflon®C/FKM-C

Main Specification

Material	Made of Unplasticized Polyvinyl Chloride (U-PVC)
Working Temperature	0 – 50°C
Maximum Working Pressure	1.0MPa{10.2kg/cm ² }

Dimensions Diagram

Socket End (13 – 50 mm)

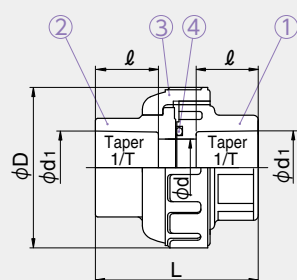

Threaded End (13 – 50 mm)

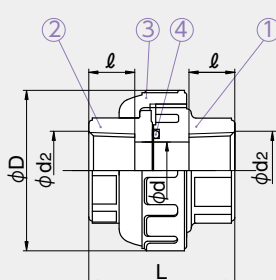

Socket End (65 – 100 mm)

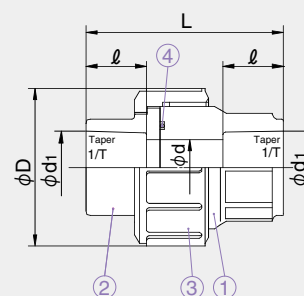

Dimensions Table

(Unit: mm)

Size	d	Socket end				Threaded end			D
		d ₁	ℓ	1/T	L	d ₂	ℓ	L	
13	13	18.13	18	1/30	46	Rc ³ / ₈	15	43	48
16	15	22.11	20	1/34	46	Rc ¹ / ₂	15	43	48
20	20	26.13	24	1/34	61	Rc ³ / ₄	17	57	60
25	25	32.16	27	1/34	70	Rc1	20	63	70
30	31	38.19	30	1/34	77	Rc1 ¹ / ₄	22	71	82
40	40	48.21	37	1/37	95	Rc1 ¹ / ₂	25	82	100
50	51	60.25	42	1/37	107	Rc2	28	96	106
65	65	76.60	61	1/48	164	—	—	—	133
75	77	89.60	64	1/49	189.5	—	—	—	152
100	100	114.70	84	1/56	245	—	—	—	210

PRODUCT MODEL CODE LIST

Threaded End TYPE L 20 – 30 mm

Type/Field	Material	Model 1	Model 2	Standard	Size of Special Connection Parts	Size
WM	2	*	*	*	*	***
WM Multi J	2 High Purity PVC (Lubricant Free Product)	1 Threaded Welding 2 Threaded Bonding	L TYPE L T TYPE T	R RC Thread End N NPT Threaded End	2 1/4 3 3/8	020 20mm I 030 30mm

Threaded End TYPE L 40 – 200 mm

Type/Field	Material	Model 1	Model 2	Standard	Size of Special Connection Parts	Size
WM	2	*	L	*	*	***
WM Multi J	2 High Purity PVC (Lubricant Free Product)	N Threaded Cast Product 2 Threaded Bonding 4 Bonding FRP Reinforcement	L TYPE L	R RC Thread End N NPT Threaded End	2 1/4 3 3/8 4 1/2 6 3/4	040 40mm I 150 150mm 200 200mm

200 mm is processed product.

Threaded End TYPE T 20 – 30 mm

Type/Field	Material	Model 1	Model 2	Standard	Size of Special Connection Parts	Size
WM	2	*	*	*	*	***
WM Multi J	2 High Purity PVC (Lubricant Free Product)	1 Threaded Welding 2 Threaded Bonding	L TYPE L T TYPE T	R RC Thread End N NPT Threaded End	2 1/4 3 3/8	020 20mm I 030 30mm

Threaded End TYPE T 40 – 200 mm

Type/Field	Material	Model 1	Model 2	Standard	Size of Special Connection Parts	Size
WM	2	*	T	*	*	***
WM Multi J	2 High Purity PVC (Lubricant Free product)	1 Welding 2 Threaded Bonding 3 Welding FRP Reinforcement 4 Bonding FRP Reinforcement	T TYPE T	R RC Thread End N NPT Threaded End	2 1/4 3 3/8 4 1/2 6 3/4	040 40mm I 200 200mm

Welding FRP reinforcement and bonding reinforcement are only available with 200 mm.

TS-Style TYPE L TYPE T 40 – 200 mm

Type/Field	Material	Model 1	Model 2	Standard	Size of Special Connection Parts	Size
WM	2	*	*	T	*	***
WM Multi J	2 High Purity PVC (Lubricant Free Product)	1 Welding 2 Bonding 3 Welding FRP Reinforcement 4 Bonding FRP Reinforcement	T TYPE T L TYPE L	T TS-Style	A 016 B 020 C 025 D 040 E 050 F 065 G 075 H 100 I 125	040 40mm I 200 200mm

Welding FRP reinforcement and bonding reinforcement are only available with 200 mm.

Multi-Joint

Main Specification

Material	High Purity Polyvinyl Chloride
Working Temperature	0-50°C

Use Example



Installation of various sensors such as pressure gauge and thermometer.



Installation of valves and cocks for sampling and draining.



Compact pipeline with reduced diameter.

Multi-Joint, TYPE L, Threaded-End Style

PRODUCT MODEL CODE

High Purity PVC (Lubricant Free product) ▶ WM 2 N L R Special Fitting Size Size



20 – 30, 200 mm

40 – 150 mm

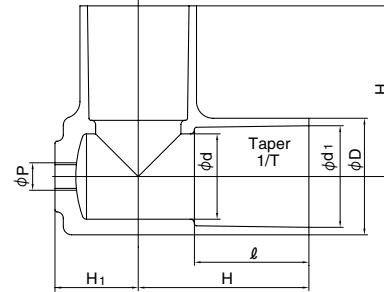
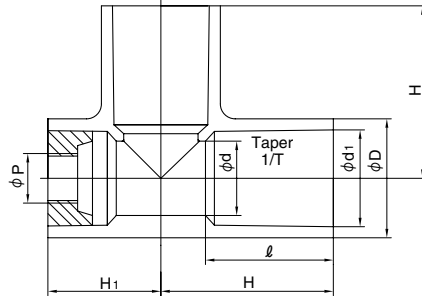

Maximum Working Pressure (20°C)

20 – 150mm	1.0MPa
200mm	0.6MPa

Combination Table

Size (mm)	Rc				NPT			
	1/4	3/8	1/2	3/4	1/4	3/8	1/2	3/4
20	○	○	-	-	○	○	-	-
25	○	○	-	-	○	○	-	-
30	○	○	-	-	○	○	-	-
40	○	○	○	○	○	○	○	○
50	○	○	○	○	○	○	○	○
65	○	○	○	○	○	○	○	○

Size (mm)	Rc				NPT			
	1/4	3/8	1/2	3/4	1/4	3/8	1/2	3/4
75	○	○	○	○	○	○	○	○
100	○	○	○	○	○	○	○	○
125	○	○	○	○	○	○	○	○
150	○	○	○	○	○	○	○	○
200	○	○	○	○	○	○	○	○

Notes: U-PVC (Gray) is not casted product so that the shape varies.

Dimensions Table

Size	d	d ₁	ℓ	1/T	D	H	H ₁
20	20	26.45	35	1/34	33	50	32
25	25	32.55	40	1/34	40	58	38
30	31	38.60	44	1/34	46	65	43
40	40	48.70	55	1/37	57	82	40
50	51	60.80	63	1/37	70	96	52
65	67	76.60	61	1/48	87	110	68

(Unit: mm)

Size	d	d ₁	ℓ	1/T	D	H	H ₁
75	77	89.60	64	1/49	102	120	74
100	100	114.70	84	1/56	130	152	98
125	125	140.85	104	1/58	157	187	126.5
150	146	166.00	132	1/63	186	230	151.5
200	196	217.00	145	1/50	240	266	193

Multi-Joint, TYPE T, Threaded-End Style

PRODUCT MODEL CODE

High Purity PVC (Lubricant Free Product) ▶ WM 2 Model 1 T Standard Special Fitting Size Size

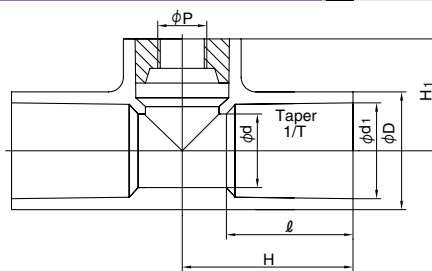

Maximum Working Pressure (20°C)

20 – 150mm	1.0MPa
200mm	0.6MPa

Combination Table

Size (mm)	Rc				NPT			
	1/4	3/8	1/2	3/4	1/4	3/8	1/2	3/4
20	○	○	-	-	○	○	-	-
25	○	○	-	-	○	○	-	-
30	○	○	-	-	○	○	-	-
40	○	○	○	○	○	○	○	○
50	○	○	○	○	○	○	○	○
65	○	○	○	○	○	○	○	○

Size (mm)	Rc				NPT			
	1/4	3/8	1/2	3/4	1/4	3/8	1/2	3/4
75	○	○	○	○	○	○	○	○
100	○	○	○	○	○	○	○	○
125	○	○	○	○	○	○	○	○
150	○	○	○	○	○	○	○	○
200	○	○	○	○	○	○	○	○

Dimensions Table

Size	d	d ₁	ℓ	1/T	D	H	H ₁
20	20	26.45	35	1/34	33	50	32
25	25	32.55	40	1/34	40	58	38
30	31	38.6	44	1/34	46	65	43
40	40	48.7	55	1/37	57	82	55
50	51	60.8	63	1/37	70	90	61
65	67	76.6	61	1/48	87	100	68

(Unit: mm)

Size	d	d ₁	ℓ	1/T	D	H	H ₁
75	77	89.6	64	1/49	102	100	75
100	100	114.7	84	1/56	130	140	100
125	125	140.85	104	1/58	157	160	115
150	146	166	132	1/63	186	195	126
200	196	217	145	1/50	240	201	148

Multi-Joint, TYPE L, TS-Style

PRODUCT CODE: WM 2 Model 1 L T Special Fitting Size Size

Maximum Working Pressure (20°C)

20 – 150mm	1.0MPa
200mm	0.6MPa

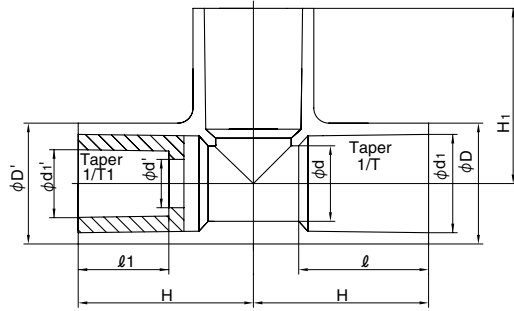

Combination Table

Size (mm)	Model	16	20	25	40	50	65	75	100	125
40	TYPE L	☆	☆	☆						
	TYPE T	☆	★	★						
50	TYPE L	☆	☆	☆						
	TYPE T	★	★	★						
65	TYPE L	☆	☆	☆	☆					
	TYPE T	☆	☆	☆	★					
75	TYPE L	☆	☆	☆	☆	☆				
	TYPE T	☆	☆	★	★	★				
100	TYPE L	☆	☆	☆	☆	☆	☆			
	TYPE T	☆	☆	☆	☆	★	☆			
125	TYPE L	☆	☆	☆	☆	☆	☆	☆		
	TYPE T	☆	☆	☆	☆	☆	☆	★		
150	TYPE L	☆	☆	☆	☆	☆	☆	☆	☆	
	TYPE T	☆	☆	☆	☆	☆	☆	★	★	
200	TYPE L	☆	☆	☆	☆	☆	☆	☆	☆	☆
	TYPE T	☆	☆	☆	☆	☆	☆	★	★	☆

Notes: ★ can be handled with TS fitting.

Dimensions Table

(Unit: mm)

Size	d	d ₁	ℓ	1/T	D	d'	d ₁ '	ℓ'	1/T1	D'	H	H ₁
40x 16	40	48.70	55	1/37	57	16	22.40	30	1/34	57	82	82
40x 20	40	48.70	55	1/37	57	20	26.45	35	1/34	57	82	82
40x 25	40	48.70	55	1/37	57	25	32.55	40	1/34	57	82	82
50x 16	51	60.80	63	1/37	70	16	22.40	30	1/34	70	96	96
50x 20	51	60.80	63	1/37	70	20	26.45	35	1/34	70	96	96
50x 25	51	60.80	63	1/37	70	25	32.55	40	1/34	70	96	96
65x 16	67	76.60	61	1/48	87	16	22.40	30	1/34	87	110	110
65x 20	67	76.60	61	1/48	87	20	26.45	35	1/34	87	110	110
65x 25	67	76.60	61	1/48	87	25	32.55	40	1/34	87	110	110
65x 40	67	76.60	61	1/48	87	40	48.70	55	1/37	87	110	110
75x 16	77	89.60	64	1/49	102	16	22.40	30	1/34	102	120	120
75x 20	77	89.60	64	1/49	102	20	26.45	35	1/34	102	120	120
75x 25	77	89.60	64	1/49	102	25	32.55	40	1/34	102	120	120
75x 40	77	89.60	64	1/49	102	40	48.70	55	1/37	102	120	120
75x 50	77	89.60	64	1/49	102	51	60.80	63	1/37	102	120	120
100x 16	100	114.70	84	1/56	130	16	22.40	30	1/34	130	152	152
100x 20	100	114.70	84	1/56	130	20	26.45	35	1/34	130	152	152
100x 25	100	114.70	84	1/56	130	25	32.55	40	1/34	130	152	152
100x 40	100	114.70	84	1/56	130	40	48.70	55	1/37	130	152	152
100x 50	100	114.70	84	1/56	130	51	60.80	63	1/37	130	152	152
100x 65	100	114.70	84	1/56	130	67	76.60	61	1/48	130	152	152
125x 16	125	140.85	104	1/58	157	16	22.40	30	1/34	157	187	187
125x 20	125	140.85	104	1/58	157	20	26.45	35	1/34	157	187	187
125x 25	125	140.85	104	1/58	157	25	32.55	40	1/34	157	187	187
125x 40	125	140.85	104	1/58	157	40	48.70	55	1/37	157	187	187
125x 50	125	140.85	104	1/58	157	51	60.80	63	1/37	157	187	187
125x 65	125	140.85	104	1/58	157	67	76.60	61	1/48	157	187	187
125x 75	125	140.85	104	1/58	157	77	89.60	64	1/49	157	187	187
150x 16	146	166.00	132	1/63	186	16	22.40	30	1/34	186	230	230
150x 20	146	166.00	132	1/63	186	20	26.45	35	1/34	186	230	230
150x 25	146	166.00	132	1/63	186	25	32.55	40	1/34	186	230	230
150x 40	146	166.00	132	1/63	186	40	48.70	55	1/37	186	230	230
150x 50	146	166.00	132	1/63	186	51	60.80	63	1/37	186	230	230
150x 65	146	166.00	132	1/63	186	67	76.60	61	1/48	186	230	230
150x 75	146	166.00	132	1/63	186	77	89.60	64	1/49	186	230	230
150x100	146	166.00	132	1/63	186	100	114.70	84	1/56	186	230	230
200x 16	196	217.00	145	1/50	240	16	22.40	30	1/34	240	266	266
200x 20	196	217.00	145	1/50	240	20	26.45	35	1/34	240	266	266
200x 25	196	217.00	145	1/50	240	25	32.55	40	1/34	240	266	266
200x 40	196	217.00	145	1/50	240	40	48.70	55	1/37	240	266	266
200x 50	196	217.00	145	1/50	240	51	60.80	63	1/37	240	266	266
200x 65	196	217.00	145	1/50	240	67	76.60	61	1/48	240	266	266
200x 75	196	217.00	145	1/50	240	77	89.60	64	1/49	240	266	266
200x100	196	217.00	145	1/50	240	100	114.70	84	1/56	240	266	266
200x125	196	217.00	145	1/50	240	125	140.85	104	1/58	240	266	266

Multi-Joint, TYPE T, TS-Style

PRODUCT MODEL CODE

High Purity PVC (Lubricant Free product) ▶ WM 2 Model 1 T T Special Fitting Size Size

Maximum Working Pressure (20°C)

20 – 150mm	1.0MPa
200mm	0.6MPa

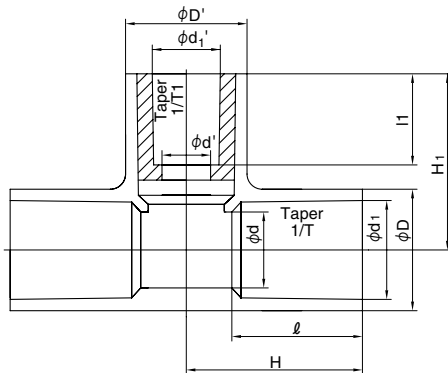

Combination Table

Size (mm)	Model	16	20	25	40	50	65	75	100	125
40	TYPE L	☆	☆	☆						
	TYPE T	☆	★	★						
50	TYPE L	☆	☆	☆						
	TYPE T	★	★	★						
65	TYPE L	☆	☆	☆	☆					
	TYPE T	☆	☆	☆	★					
75	TYPE L	☆	☆	☆	☆	☆				
	TYPE T	☆	☆	★	★	★				
100	TYPE L	☆	☆	☆	☆	☆	☆			
	TYPE T	☆	☆	☆	☆	★	☆			
125	TYPE L	☆	☆	☆	☆	☆	☆	☆		
	TYPE T	☆	☆	☆	☆	☆	☆	★		
150	TYPE L	☆	☆	☆	☆	☆	☆	☆	☆	
	TYPE T	☆	☆	☆	☆	☆	☆	★	★	
200	TYPE L	☆	☆	☆	☆	☆	☆	☆	☆	☆
	TYPE T	☆	☆	☆	☆	☆	☆	★	★	☆

Notes: ★ can be handled with TS fitting.

Dimensions Table

(Unit: mm)

Size	d	d ₁	ℓ	1/T	D	d'	d ₁ '	ℓ'	1/T ₁	D'	H	H ₁
40× 16	40	48.70	55	1/37	57	16	22.40	30	1/34	57	82	82
65× 16	67	76.60	61	1/48	87	16	22.40	30	1/34	57	95	95
65× 20	67	76.60	61	1/48	87	20	26.45	35	1/34	57	95	95
65× 25	67	76.60	61	1/48	87	25	32.55	40	1/34	57	95	95
75× 16	77	89.60	64	1/49	102	16	22.40	30	1/34	57	100	102
75× 20	77	89.60	64	1/49	102	20	26.45	35	1/34	57	100	102
100× 16	100	114.70	84	1/56	130	16	22.40	30	1/34	70	125	122
100× 20	100	114.70	84	1/56	130	20	26.45	35	1/34	70	125	122
100× 25	100	114.70	84	1/56	130	25	32.55	40	1/34	70	125	122
100× 40	100	114.70	84	1/56	130	40	48.70	55	1/37	102	140	132
100× 65	100	114.70	84	1/56	130	67	76.60	61	1/48	130	152	152
125× 16	125	140.85	104	1/58	157	16	22.40	30	1/34	102	161	147
125× 20	125	140.85	104	1/58	157	20	26.45	35	1/34	102	161	147
125× 25	125	140.85	104	1/58	157	25	32.55	40	1/34	102	161	147
125× 40	125	140.85	104	1/58	157	40	48.70	55	1/37	102	161	147
125× 50	125	140.85	104	1/58	157	51	60.80	63	1/37	102	161	147
125× 65	125	140.85	104	1/58	157	67	76.60	61	1/48	130	175	167
150× 16	146	166.00	132	1/63	186	16	22.40	30	1/34	102	195	158
150× 20	146	166.00	132	1/63	186	20	26.45	35	1/34	102	195	158
150× 25	146	166.00	132	1/63	186	25	32.55	40	1/34	102	195	158
150× 40	146	166.00	132	1/63	186	40	48.70	55	1/37	102	195	158
150× 50	146	166.00	132	1/63	186	51	60.80	63	1/37	102	195	158
150× 65	146	166.00	132	1/63	186	67	76.60	61	1/48	130	208	182
200× 16	194	217.00	145	1/50	240	16	22.40	30	1/34	102	201	180
200× 20	194	217.00	145	1/50	240	20	26.45	35	1/34	102	201	180
200× 25	194	217.00	145	1/50	240	25	32.55	40	1/34	102	201	180
200× 40	194	217.00	145	1/50	240	40	48.70	55	1/37	102	201	180
200× 50	194	217.00	145	1/50	240	51	60.80	63	1/37	102	201	180
200× 65	194	217.00	145	1/50	240	67	76.60	61	1/48	130	215	200
200×125	194	217.00	145	1/50	240	125	140.85	104	1/58	240	266	266

Joint Equipment

Special connector is available for secure and efficient installation of high purity resistance polyvinyl chloride pipes (HP-PVC).

Bonding Connection (Insertion bonding machine)



Description	INSER-50
Applicable Size	13 – 50 mm
Input Power Source	–
Maximum Power Consumption	–
Dimensions (mm)	Body: L1080×W430×H1000
Weight (kg)	Body: 80

* INSER-50 is a manual type (power source not required).



Description	INSER-200
Applicable Size	65 – 200 mm
Input Power Source	200V (three-phase) / 50 to 60Hz / 20A
Maximum Power Consumption	5.0kW
Dimensions (mm)	Body: L1500×W760×H1110
Weight (kg)	Body: 500

* Power source plug is not equipped on INSER-200 when shipped. Please prepare and wire depending on the power source condition on site.

Welding Connection (Welding machine)



Description	AV-150
Applicable Size	75 – 150 mm
Input Power Source	200V (three-phase) / 50 to 60Hz / 60A
Maximum Power Consumption	12.0kW
Dimensions (mm)	Body: L1325×W900×H1150
Weight (kg)	Body: 460

* Power source plug is not equipped on AV150 when shipped. Please prepare and wire depending on the power source condition on site.



Description	PRISMA125C
Applicable Size	13 – 75 mm
Input Power Source	110V / 50 to 60Hz / 15A
Maximum Power Consumption	1.4kW
Dimensions (mm)	Body: L1500×W840×H1300
Weight (kg)	Body: 100

* Insertion bonding machine is a special machine for ASAHI AV polyvinyl chloride pipe & fittings, C-PVC pipe & fittings and high purity pipe & fittings. It cannot be used for pipe & fittings of other manufacturers and materials.

* Fusion machine is a special machine for high purity resistance polyvinyl chloride pipes (HP-PVC). It cannot be used for pipe & fittings of other manufacturers and materials.

* We lease this machines. For details, please consult our nearest office, when necessary.

* Our supervisor will provide handling instructions before using this machine, as necessary. Please consult our nearest office.

* The number of this machines is limited. We may not be able to accept your request depending on the condition.

* Please read manuals and installation procedures carefully and install properly.

Piping Design Precautions

- Select an appropriate material in consideration of use conditions (fluid type, temperature, pressure, etc.) For details, please consult our nearest office in advance.
- Maximum working pressure is the pressure including the water hammer pressure. Do not use them exceeding the maximum working pressure.
- As maximum working pressure differs by size and temperature, design and use within the allowable range.
- Since they are made from plastic, heat expansion/contraction against temperature change is large compared to metals and heat stress is also generated. Therefore, perform piping support or expansion/construction treatment applicable to the use conditions and installation place.
- In the case of using under the positive-pressure gas, a dangerous condition is expected due to the particular reaction force of compressive fluid even when the value is the same as the water pressure. Therefore, implement a safety measure such as covering pipes with a protection material, etc. to protect the surrounding area before use.
- Do not joint with solvent adhesive or welding connection on differential plastic materials (It may cause damage)

Transportation Precautions

- Do not drag them as it could scratch pipes. Do not drag them as both ends of pipes are easily damaged.

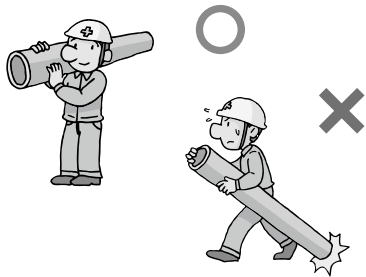

- Two people should handle a pipe with the size of 150 mm or more.

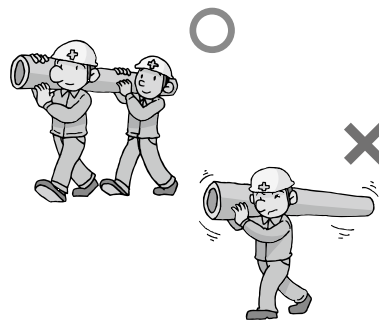

- Do not throw pipes from the truck platform.

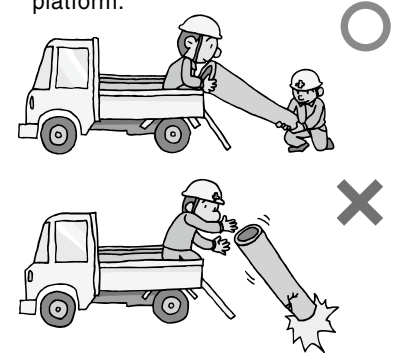

Storage Precautions

- When storing pipes and fittings outside, avoid direct sunlight and implement a measure such as placing a sheet in a way of avoiding heat accumulation.

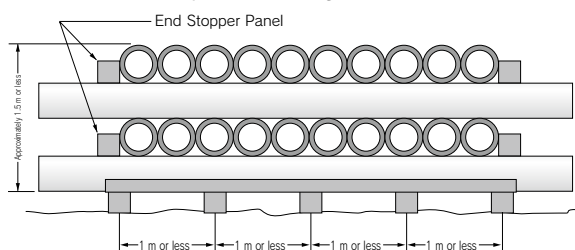

- Do not leave fittings in an enclosed condition (inside a vehicle in Summer, in an enclosed plastic bag, etc.) under a high temperature atmosphere.

Enclosed vehicle
(may deform due to heat)

Packed products in an
sealed condition

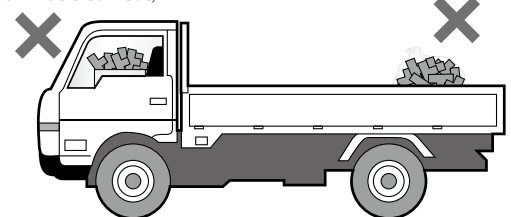

Installation

- Follow our installation procedure to fully exert the work safety and piping performance for installation.
- Make sure to use the specified AV cement for bonding AV PVC pipes.
- Be cautious of excessive adhesive (it may cause solvent cracking and damage).

Caution is needed in low-temperature installation because solvent steam does not evaporate easily and tends to remain (it may cause solvent cracking and damage). During curing after piping, open both ends of pipe without enclosing and remove the solvent steam. During curing, it can be removed more effectively by ventilating inside piping using a ventilator (low-pressure specification) or washing inside piping by filling the water fully after the adhesive is hardened.

- Make sure to perform a completion inspection under water pressure. Do not perform an airtightness test by using air (compressed air or positive-pressure gas) as it is extremely dangerous.

Solvent Cracking (SC) Measure

SC (Solvent Cracking) is a type of stress cracking and specifically distinguished from the cracking phenomenon that occurs when solvent gives an impact inside PVC pipe. SC is caused by the existence of solvent (adhesive, preservative, etc.)

It tends to occur more easily due to stress (heat stress, stress of TS connection part, bending, other external stress) and installation during low-temperature like in Winter (solvent tends to remain). When piping, implement a SC measure as explained as follows.

Item	Measure
Adhesive Usage	Apply adhesive compatible to the type of pipe thinly and evenly. Do not apply adhesive extending out from the insertion length on the pipe outer face. In particular, apply thinly and evenly to the inner face of fitting. The reference ratio of adhesive application is 7 to 3 for pipe and fitting.
Wiping of Adhesive	After bonding, make sure to wipe off the protruded adhesive with a cloth after inserting. During application, remove the adhesive spilled on the groove floor.
Opening of pipe on both ends	Fully open valve, air valve, blind flange, etc. for better ventilation and remove the solvent stream. Do not enclose them.
Utilization of Prefab Method	Prefabricate 2 to 4 pipes in advance, remove the solvent steam by natural ventilation and then connect the pipes.
Ventilation inside Piping	During curing after piping, open both ends of pipe without enclosing and remove the solvent steam. Do not enclose them. During curing, the steam can be removed more effectively by ventilating inside piping using a ventilator (low-pressure specification).
Washing inside Piping	During curing after piping, open both ends of pipe without enclosing and remove the solvent steam. It is more effective if you fill water all the way and wash after the adhesive is hardened (do not apply the water pressure at this time). Immediately perform this after leaving 30 minutes for the size of 50 mm or less and approximately 1 hour for the size of 65 mm or more.
Expansion Measure	Implement an expansion/contraction treatment to prevent the heat stress from rising due to temperature differences.
Support	When fixing piping, try to avoid using U-bolts as much as possible and use fixation bands with a wider width. In the case of using U-bolts, provide a cushion such as rubber to prevent piping from touching U-bolts. Be fully cautious not to tighten the fixation bands and U-bolts too much.

Adhesive Usage

Do not apply adhesive extending out from the gauge line.

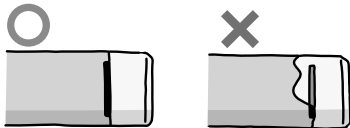

Apply thinly and evenly to the inner face of TS fitting gasket.

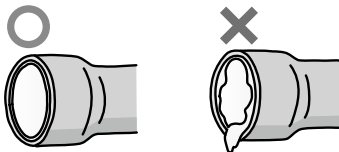

Wiping of Adhesive

Wipe off the protruded adhesive with a cloth after inserting.

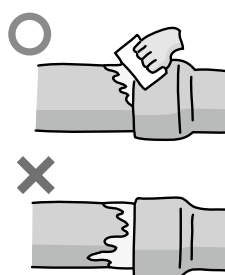

Support

Be cautious not to tighten saddle bands, U-bolts and U-bands too much.

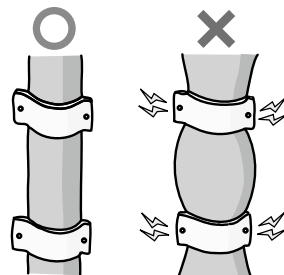

Expansion Measure

Provide expansion/contraction treatment to lower the heat stress.

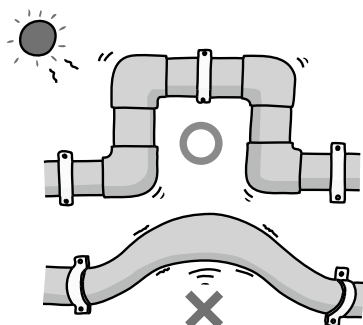

Removal of Solvent and Opening of Pipe on Both Ends

Ventilation



Washing with water



Opening of pipe on both ends

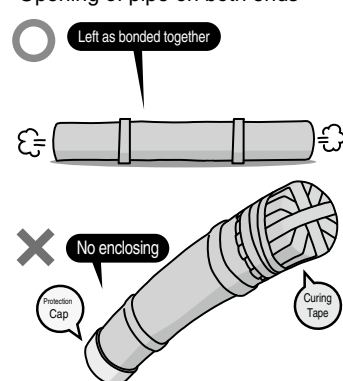

ASAHI 

Chemical Pipe

Chemical Pipe | P.108

Technical Document | P.109

Chemical

PRODUCT MODEL CODE LIST

Type	Field	Material	Standard/Wall Thickness	Standard	Type	Size	Length
P	N	K	PP	J	N	***	04
⋮	⋮	⋮	⋮	⋮	⋮	⋮	⋮
P Pipe	N Standard	K Chemical	PP Straight Pipe VP	J JIS	N Standard	016 16mm 300 300mm	04 4m

Straight Pipe (Chemical Pipe)

PRODUCT MODEL CODE

P N K PP J N Size 04



Excellent chemical-resistance

Higher chemical-resistance compared to general unplasticized polyvinyl chloride pipes and excellent penetration resistance specially against hydrochloric acid, fluorine, etc.

Long-term durability

Excellent long-term durability with high creep property.

High pressure-resistant capability

Excellent safety and reliability with high pressure-resistant strength.

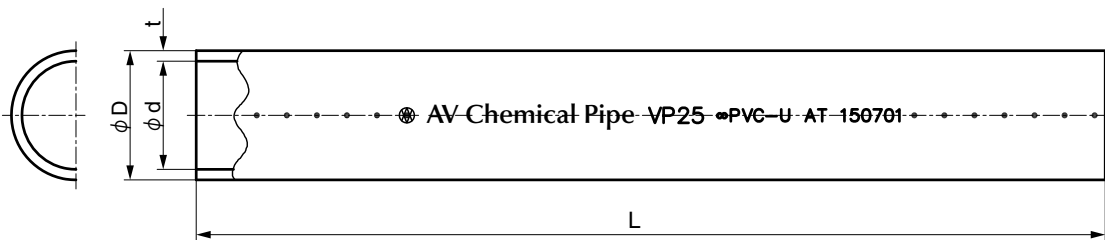

■ Dimensions Table

(Unit: mm)

Size	D (Outer Diameter)			t (Thickness)		d (Approximate Inner Diameter)	L (Overall Length)	Weight per 1m (Reference) (kg/m)
	Basic Dimension	Max/Min. Outer Dimensional Tolerance	Average Outer Dimensional Tolerance	Min Dimension	Tolerance			
16	22.0	±0.2	±0.2	2.7	+0.6	16	4000 ±10	0.256
20	26.0	±0.2	±0.2	2.7	+0.6	20	4000 ±10	0.310
25	32.0	±0.2	±0.2	3.1	+0.8	25	4000 ±10	0.448
30	38.0	±0.3	±0.2	3.1	+0.8	31	4000 ±10	0.542
40	48.0	±0.3	±0.2	3.6	+0.8	40	4000 ±10	0.791
50	60.0	±0.4	±0.2	4.1	+0.8	51	4000 ±10	1.122
65	76.0	±0.5	±0.3	4.1	+0.8	67	4000 ±10	1.445
75	89.0	±0.5	±0.3	5.5	+0.8	77	4000 ±10	2.202
100	114.0	±0.6	±0.4	6.6	+1.0	100	4000 ±10	3.409
125	140.0	±0.8	±0.5	7.0	+1.0	125	4000 ±10	4.464
150	165.0	±1.0	±0.5	8.9	+1.4	146	4000 ±10	6.701
200	216.0	±1.3	±0.7	10.3	+1.4	194	4000 ±10	10.129
250	267.0	±1.6	±0.9	12.7	+1.8	240	4000 ±10	15.481
300	318.0	±1.9	±1.0	15.1	+2.2	286	4000 ±10	21.962

Notes: Various fittings to connect to chemical pipes are TS fittings.

Chemical-resistance

<Sectional Picture of VP50 Impregnated Piece>

- Hydrochloric acid 35%, 50°C、12 days of impregnation

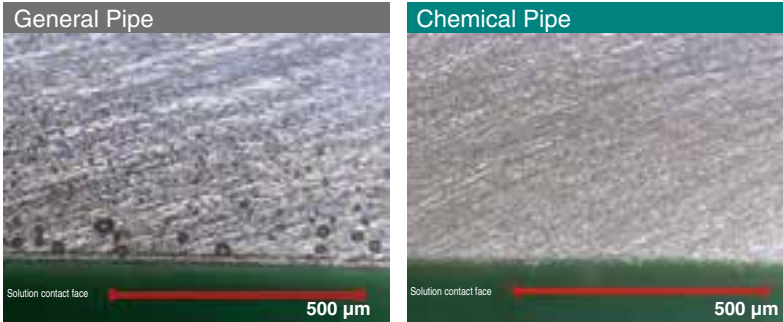

Effusion of hydrochloric acid is seen with the general pipe but completely free from it with the chemical pipe.

- Weight change (Hydrochloric acid 35%, 50°C)

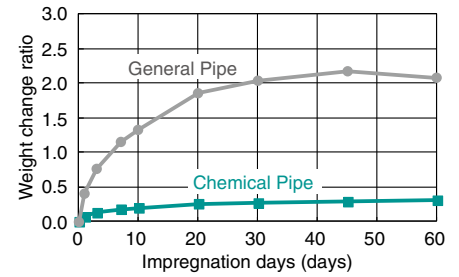

- Weight change (Nitric acid 65%, 50°C)

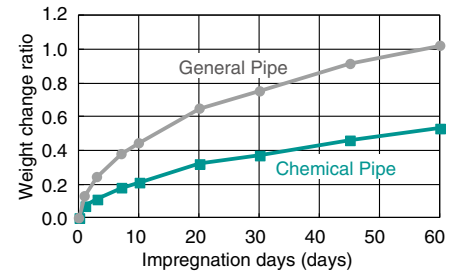

Basic Property

Item	Type	Chemical Pipe	General Pipe
Tensile strength (MPa)		58.7	57.5
Extension Ratio (%)		182	186
Izod Impact Value (kJ/m ²)		7.5	6.5
Vicat Softening Temperature (°C)		84.0	83.7

Notes: Various fittings to connect to chemical pipes are conventional TS fittings, but they have the equivalent chemical-resistance to chemical pipes.

Short-Term Burst Pressure Test

(Unit: MPa)

Size	Type	Chemical Pipe	General Pipe
VP50		10.0	9.2
VP100		8.4	6.8
VP200		6.8	5.4

Creep Property

<Creep Test Results>

- Circumferential stress 12.5MPa, 60°C

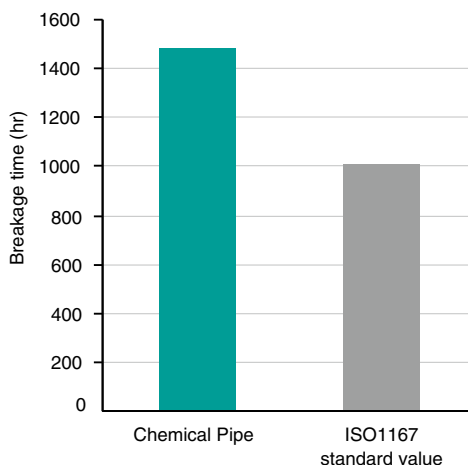

ASAHI AV

ASAHI 

AV Pipe & Fittings

Product Type/Prefabricated Product	P.112
AV Pipe	P.113
AV Fitting	P.114
Flange	P.118
Technical Document	P.119



Strong

Type

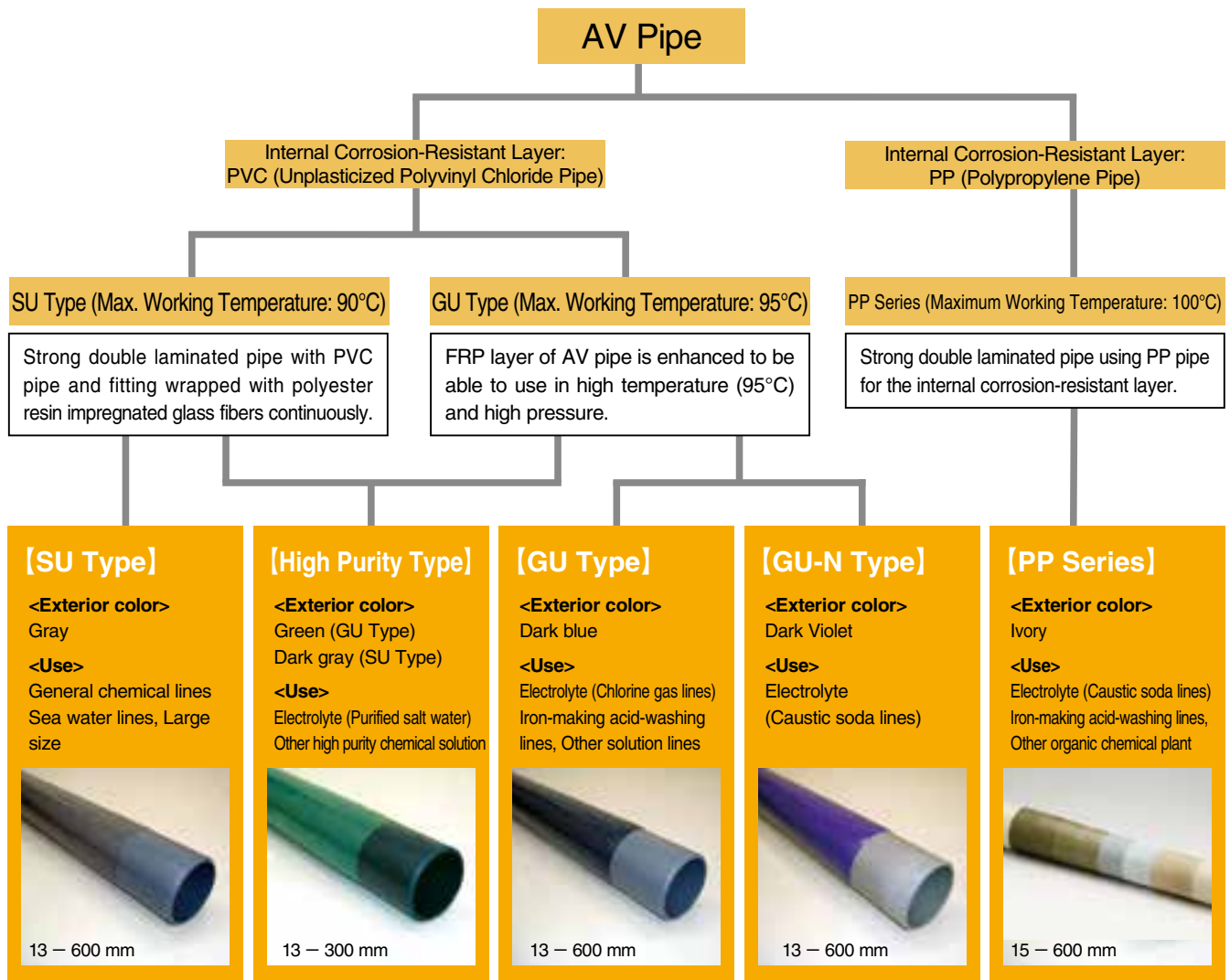

* Exterior color is changeable on request.
 * PP Series will be delivered only in prefabricated condition (end flange connection).
 For details, please contact our nearest office.

Prefab Product

"Field production is difficult because piping shape is complicated..."

"We want to minimize field fabrication..."

In these cases, we can manufacture them at our factory and deliver to you. Please feel free to contact us.



PRODUCT MODEL CODE LIST

Type	Field	Material	Standard/Wall Thickness	Standard	Type	Size	Length
P	*	*	**	J	N	***	04
P Pipe	F SU G GU	U U-PVC 2 High Purity N GU-N	PP Straight Pipe VP UP Straight Pipe VU P6 Single-Side Sleeve VP U6 Single-Side Sleeve VU	J JIS	N Standard	013 13mm I 600 600mm	04 4m

AV Pipe FRP Layer Wall Thickness

* FRP layer wall thickness (mm) is reference value.
It is not guaranteed.

Product Name	Size (mm)	FRP Layer Wall Thickness (mm)
AV-SU Pipe, Socket, Reducer	13 – 600	1.2
AV-SU Elbow, Tee		1.4
AV-GU Elbow, Tee	13 – 40	1.4
	13 – 40	1.2
AV-GU Pipe, Socket, Reducer, Elbow, Tee	50 – 125	2.4
	150 – 350	3.8
	400, 450	5.2
	500, 600	5.9

Straight Pipe

PRODUCT MODEL CODE

SU ▶ P F U PP J N Size 04
GU ▶ P G U PP J N Size 04

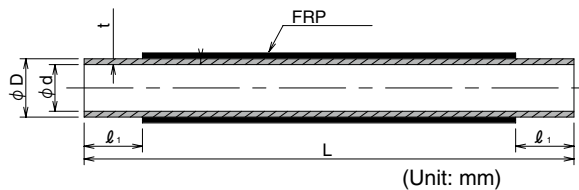

Dimensions Table (Unit: mm)

Size	L	ℓ ₁	D	d	t	Reference Weight (kg)	
						SU	GU
13	4000	45	18	13	2.5	1.50	1.50
16	4000	50	22	16	3.0	1.74	1.74
20	4000	55	26	20	3.0	2.37	2.37
25	4000	60	32	25	3.5	3.17	3.17
30	4000	65	38	31	3.5	3.79	3.79
40	4000	80	48	40	4.0	5.20	5.20
50	4000	90	60	51	4.5	7.00	8.32
65	4000	95	76	67	4.5	8.96	10.52
75	4000	100	89	77	6.0	12.64	13.94
100	4000	120	114	100	7.0	18.16	20.21

Size	L	ℓ ₁	D	d	t	Reference Weight (kg)	
						SU	GU
125	4000	150	140	125	7.5	23.64	25.93
150	4000	180	165	146	9.5	33.36	39.14
200	4000	190	216	194	11.0	49.38	58.45
250	4000	200	267	240	13.5	72.88	81.88
300	4000	200	318	286	16.0	101.38	110.73
350	4000	330	370	348	11.0	89.18	104.94
400	4000	370	420	395	12.5	112.20	145.15
450	4000	400	470	442	14.0	137.83	174.71
500	4000	410	520	489	15.5	166.08	215.78
600	4000	480	630	592	19.0	234.16	298.64

Notes: Dimension 300 mm is for SU Type and GU Type.

Single-Side Sleeve

PRODUCT MODEL CODE

SU ▶ P F U P6 J N Size 04
GU ▶ P G U P6 J N Size 04

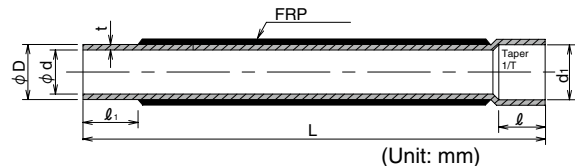

Dimensions Table (Unit: mm)

Size	L	ℓ ₁	ℓ	d ₁	1/T	D	d	t	Reference Weight (kg)	
									SU	GU
13	4000	45	26	18.40	1/30	18	13	2.5	1.50	1.50
16	4000	50	30	22.40	1/34	22	16	3.0	1.74	1.74
20	4000	55	35	26.45	1/34	26	20	3.0	2.37	2.37
25	4000	60	40	32.55	1/34	32	25	3.5	3.17	3.17
30	4000	65	44	38.60	1/34	38	31	3.5	3.79	3.79
40	4000	80	55	48.70	1/37	48	40	4.0	5.20	5.20
50	4000	90	63	60.80	1/37	60	51	4.5	7.00	8.32
65	4000	95	61	76.60	1/48	76	67	4.5	8.96	10.52
75	4000	100	64	89.60	1/49	89	77	6.0	12.64	13.94
100	4000	120	84	114.70	1/56	114	100	7.0	18.16	20.21

Size	L	ℓ ₁	ℓ	d ₁	1/T	D	d	t	Reference Weight (kg)	
									SU	GU
125	4000	150	104	140.80	1/58	140	125	7.5	23.64	25.93
150	4000	180	132	166.00	1/63	165	146	9.5	33.36	39.14
200	4000	190	145	217.00	1/50	216	194	11.0	49.38	58.45
250	4000	200	155	267.70	1/55	267	240	13.5	72.88	81.88
300	4000	200	155	318.70	1/55	318	286	16.0	101.38	110.73
350	4000	330	280	373.00	1/43	370	348	11.0	89.18	104.94
400	4000	370	320	423.00	1/48	420	395	12.5	112.20	145.15
450	4000	400	350	474.00	1/45	470	442	14.0	137.83	174.71
500	4000	410	350	524.50	1/50	520	489	15.5	166.08	215.78
600	4000	480	410	635.00	1/50	630	592	19.0	234.16	298.64

Notes: Dimension 300 mm is for SU Type and GU Type.

PRODUCT MODEL CODE LIST

Type	Field	Material	Standard/Wall Thickness	Standard	Type	Size
*	*	*	**	J	N	***
⋮	⋮	⋮	⋮	⋮	⋮	⋮
T Elbow	F SU	U U-PVC	9L Elbow (90°)	J JIS	N Standard	013 13mm
B Bend	G GU	2 High Purity	90 Bend (90°)	V JIS		I
		N GU-N	4L Elbow (45°)			600 600mm
			45 Bend (45°)			
			TE Tee			
			SO Socket			
			P6 Single-Side Sleeve VP			
			U6 Single-Side Sleeve VU			

AV TS Fitting Common Dimensions

(Unit: mm)

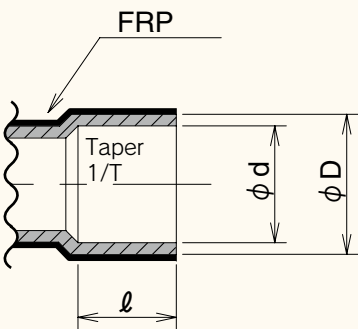

Notes: ℓ dimension differs slightly depending on the fitting such as bend, etc. Please refer to details in Fitting Dimensions Table.

For standard of 350 mm or over, please contact our nearest office.

Size	D	d	ℓ	1/T
13	24	18.40	26	1/30
16	29	22.40	30	1/34
20	33	26.45	35	1/34
25	40	32.55	40	1/34
30	46	38.60	44	1/34
40	57	48.70	55	1/37
50	70	60.80	63	1/37
65	87	76.60	61	1/48
75	102	89.60	64	1/49
100	130	114.70	84	1/56
125	157	140.85	104	1/58
150	186	166.00	132	1/63
200	235	217.00	145	1/50
250	295	268.20	155	1/48
300	336	318.70	175	1/55

Elbow, Bend (90°)

PRODUCT MODEL CODE

Elbow SU	▶	T	F	U	9L	J	N	Size
Elbow GU	▶	T	G	U	9L	J	N	Size
Bend SU	▶	B	F	U	90	V	N	Size
Bend GU	▶	B	G	U	90	V	N	Size

Elbow

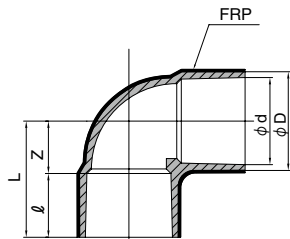

90° Elbow

Bend

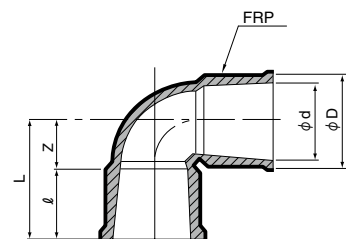

90° Bend

Dimensions Table

(Unit: mm)

Size	L	ℓ	Z	D	d	Reference Weight (kg)	
						SU	GU
13	36	26	10	24	18.40	0.05	0.05
16	43	30	13	29	22.40	0.07	0.07
20	50	35	15	33	26.45	0.09	0.09
25	58	40	18	40	32.55	0.15	0.15
30	65	44	21	46	38.60	0.20	0.20
40	82	55	27	57	48.70	0.30	0.30
50	96	63	33	70	60.80	0.40	0.48
65	110	61	49	87	76.60	0.60	0.70
75	120	64	56	102	89.60	0.98	1.16
100	153	84	69	130	114.70	1.85	2.19
125	188	104	84	157	140.85	3.06	3.32
150	230	132	98	186	166.00	5.03	5.90
200	265	145	120	240	217.00	7.97	9.40
250	311	155	156	295	268.20	13.16	15.30
300	350	175	175	347	319.60	17.20	20.40

Dimensions Table

(Unit: mm)

Size	L	ℓ	Z	D	d	Reference Weight (kg)	
						SU	GU
75	137	72	65	101	89.80	0.80	0.88
100	172	92	80	129	115.00	1.50	1.70
125	237	112	125	156	141.20	2.60	2.90
150	260	140	120	185	166.50	4.10	4.80
200	341	145	196	240	217.00	7.70	9.20
250	402	155	247	293	268.20	11.00	12.70
300	395	155	230	337	318.70	12.20	14.00

Notes: 1. Elbow is standard, unless otherwise specified.
2. Size of 350 mm or over can also be manufactured. Please consult our nearest office.

Elbow, Bend (45°)

PRODUCT MODEL CODE	Elbow SU	T	F	U	4L	J	N	Size
	Elbow GU	T	G	U	4L	J	N	Size
	Bend SU	B	F	U	45	V	N	Size
	Bend GU	B	G	U	45	V	N	Size

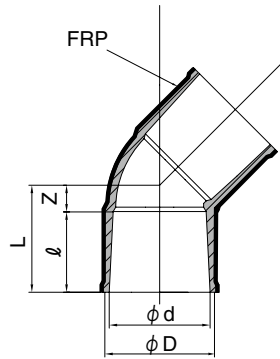

Elbow, Bend (45°)

■ Dimensions Table

45° Elbow 20 – 25 mm

(Unit: mm)

Size	L	l	Z	D	d	Reference Weight (kg)	
						SU	GU
20	44	35	9	33	26.45	0.08	0.08
25	51	40	11	40	32.55	0.12	0.12

45° Bend 40 – 300 mm

(Unit: mm)

Size	L	l	Z	D	d	Reference Weight (kg)	
						SU	GU
40	69	55	14	57	48.70	0.30	0.30
50	80	63	17	70	60.80	0.40	0.40
65	81	61	20	87	76.60	0.57	0.63
75	97	72	25	101	89.80	0.65	0.72
100	122	92	30	129	115.00	1.30	1.40
125	149	112	37	156	141.20	2.10	2.30
150	184	140	44	185	166.50	3.10	3.60
200	193	145	48	240	217.00	5.30	6.30
250	213	155	58	293	268.20	7.20	8.30
300	225	155	70	337	318.70	9.30	10.70

Notes: Size of 350 mm or over can also be manufactured. Please consult our nearest office.

Tee

PRODUCT MODEL CODE	SU	T	F	U	TE	J	N	Size
	GU	T	G	U	TE	J	N	Size

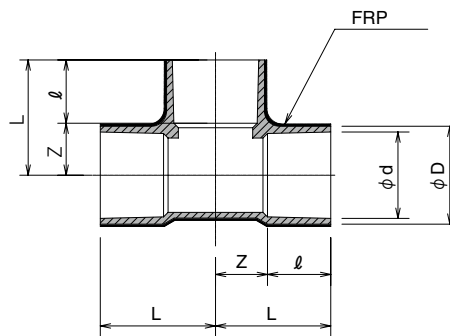

Tee

■ Dimensions Table

(Unit: mm)

Size	L	l	Z	D	d	Reference Weight (kg)	
						SU	GU
13	36	26	10	24	18.40	0.04	0.04
16	43	30	13	29	22.40	0.05	0.05
20	50	35	15	33	26.45	0.06	0.06
25	58	40	18	40	32.55	0.13	0.13
30	65	44	21	46	38.60	0.18	0.18
40	82	55	27	57	48.70	0.31	0.31
50	96	63	33	70	60.80	0.50	0.60
65	110	61	49	87	76.60	0.73	0.86

(Unit: mm)

Size	L	l	Z	D	d	Reference Weight (kg)	
						SU	GU
75	120	64	56	102	89.60	1.20	1.32
100	152	84	68	130	114.70	2.20	2.50
125	187	104	83	157	140.85	3.50	3.90
150	230	132	98	186	166.00	6.40	7.50
200	266	145	121	240	217.00	9.30	11.10
250	331	155	176	295	268.20	13.20	15.30
300	340	175	165	337	318.70	16.60	19.10

Notes: Size of 350 mm or over can also be manufactured. Please consult our nearest office.

Reducing Tee

PRODUCT MODEL CODE

SU ▶ T F U TE J N Size
 GU ▶ T G U TE J N Size

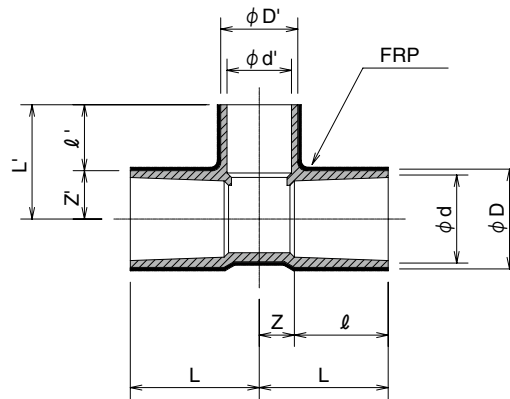

Reducing Tee

Dimensions Table

(Unit: mm)

Size	L	ℓ	Z	D	d	L'	ℓ'	Z'	D'	d'	Reference Weight (kg)	
											SU	GU
16x 13	41	30	11	29	22.40	38	26	12	24	18.40	0.04	0.04
20x 13	46	35	11	33	26.45	40	26	14	24	18.40	0.05	0.05
20x 16	48	35	13	33	26.45	45	30	15	29	22.40	0.05	0.05
25x 13	51	40	11	40	32.55	43	26	17	24	18.40	0.09	0.09
25x 16	53	40	13	40	32.55	48	30	18	29	22.40	0.10	0.10
25x 20	55	40	15	40	32.55	53	35	18	33	26.45	0.11	0.11
30x 13	55	44	11	46	38.60	46	26	20	24	18.40	0.12	0.12
30x 16	57	44	13	46	38.60	51	30	21	29	22.40	0.13	0.13
30x 20	59	44	15	46	38.60	56	35	21	33	26.45	0.14	0.14
30x 25	62	44	18	46	38.60	61	40	21	40	32.55	0.16	0.16
40x 13	66	55	11	57	48.70	52	26	26	24	18.40	0.19	0.19
40x 16	68	55	13	57	48.70	57	30	27	29	22.40	0.21	0.21
40x 20	70	55	15	57	48.70	62	35	27	33	26.45	0.22	0.22
40x 25	73	55	18	57	48.70	67	40	27	40	32.55	0.23	0.23
40x 30	76	55	21	57	48.70	71	44	27	46	38.60	0.23	0.23
50x 13	74	63	11	70	60.80	58	26	32	24	18.40	0.31	0.37
50x 16	76	63	13	70	60.80	63	30	33	29	22.40	0.34	0.40
50x 20	78	63	15	70	60.80	68	35	33	33	26.45	0.35	0.42
50x 25	81	63	18	70	60.80	73	40	33	40	32.55	0.36	0.43
50x 30	84	63	21	70	60.80	77	44	33	46	38.60	0.38	0.45
50x 40	90	63	27	70	60.80	88	55	33	57	48.70	0.45	0.54
65x 40	100	61	39	87	76.60	95	55	40	57	48.70	0.60	0.70
65x 50	101	61	40	87	76.60	104	63	41	70	60.80	0.70	0.82
75x 25	93	64	29	102	89.6	88	40	48	40	32.55	0.60	0.67
75x 40	100	64	36	102	89.6	102	55	47	57	48.70	0.85	0.94
75x 50	105	64	41	102	89.6	110	63	47	70	60.80	0.95	1.05
75x 65	113	64	49	102	89.6	117	61	56	87	76.60	1.10	1.21
100x 50	125	84	41	130	114.7	122	63	59	70	60.80	1.65	1.84
100x 75	140	84	56	130	114.7	132	64	68	102	89.60	1.85	2.06
125x 75	160	104	56	157	140.85	147	64	83	102	89.60	2.88	3.19
125x100	173	104	69	157	140.85	167	84	83	130	114.70	3.45	4.00
150x 75	195	132	63	186	166.0	158	64	94	102	89.60	4.20	5.00
150x100	208	132	76	186	166.0	182	84	98	130	114.70	5.00	5.90
150x125	217	132	85	186	166.0	201	104	97	157	140.85	5.20	6.10
200x 75	201	145	56	240	217.0	180	64	116	107.2	89.60	7.50	9.00
200x100	215	145	70	240	217.0	200	84	116	130	114.70	8.60	10.30
200x150	238	145	93	240	217.0	253	132	121	188	166.00	10.20	12.20
250x 75	226	155	71	295	268.2	210	64	146	108	89.60	11.80	14.10
250x100	246	155	91	295	268.2	225	84	141	136	114.70	13.10	15.20
250x200	304	155	149	295	268.2	310	145	165	245	217.00	17.20	20.60
300x 75	361	300	61	343	320.7	236	64	172	102	89.60	19.10	22.90

Notes: Size of 350 mm or over can also be manufactured. Please consult our nearest office.

Socket

PRODUCT MODEL CODE
 SU ▶ T F U SO J N Size
 GU ▶ T G U SO J N Size

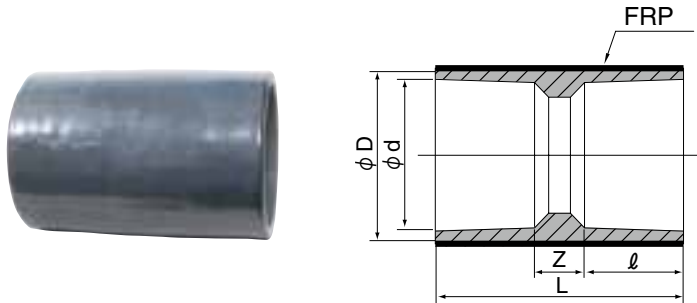

Socket

Dimensions Table

(Unit: mm)

Size	L	ℓ	Z	D	d	Reference Weight (kg)	
						SU	GU
13	57	26	5	24	18.40	0.03	0.03
16	67	30	7	29	22.40	0.04	0.04
20	77	35	7	33	26.45	0.05	0.05
25	87	40	7	40	32.55	0.08	0.08
30	95	44	7	46	38.60	0.10	0.10
40	117	55	7	57	48.70	0.20	0.20
50	133	63	7	70	60.80	0.30	0.36
65	145	61	23	87	76.60	0.40	0.47

(Unit: mm)

Size	L	ℓ	Z	D	d	Reference Weight (kg)	
						SU	GU
75	155	64	27	102	89.60	0.60	0.66
100	200	84	32	130	114.70	1.10	1.20
125	240	104	32	157	140.85	1.50	1.80
150	300	132	36	186	166.00	2.80	3.30
200	305	145	15	238	217.00	3.60	4.30
250	352	155	42	295	268.20	4.80	5.60
300	360	175	10	336	319.60	7.10	8.20

Notes: Size of 350 mm or over can also be manufactured. Please consult our nearest office.

Reducing Socket

PRODUCT MODEL CODE
 SU ▶ T F U SO J N Size
 GU ▶ T G U SO J N Size

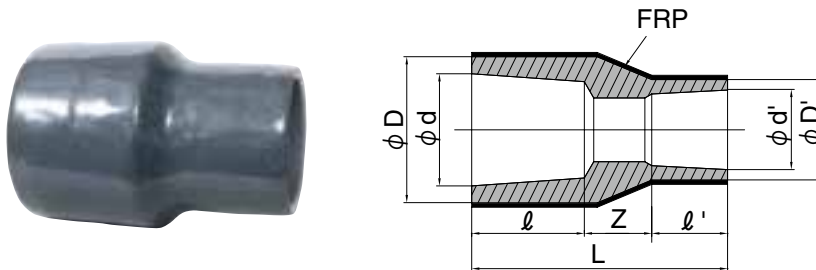

Reducing Socket

Dimensions Table

(Unit: mm)

Size	L	ℓ	D	d	ℓ'	D'	d'	Z	Reference Weight (kg)	
									SU	GU
16x13	61	30	29	22.40	26	24	18.40	5	0.05	0.05
20x13	68	35	33	26.45	26	24	18.40	7	0.06	0.06
20x16	71	35	33	26.45	30	29	22.40	6	0.06	0.06
25x13	86	40	40	32.55	26	24	18.40	20	0.08	0.08
25x16	85	40	40	32.55	30	29	22.40	15	0.08	0.08
25x20	84	40	40	32.55	35	33	26.45	9	0.08	0.08
30x20	93	44	46	38.60	35	33	26.45	14	0.12	0.12
30x25	93	44	46	38.60	40	40	32.55	9	0.12	0.12
40x20	113	55	57	48.70	35	33	26.45	23	0.16	0.16
40x25	114	55	57	48.70	40	40	32.55	19	0.17	0.17
40x30	114	55	57	48.70	44	46	38.60	15	0.18	0.18
50x20	116	63	70	60.80	35	33	26.45	18	0.20	0.24
50x25	140	63	70	60.80	40	40	32.55	37	0.24	0.29

(Unit: mm)

Size	L	ℓ	D	d	ℓ'	D'	d'	Z	Reference Weight (kg)	
									SU	GU
50x 30	136	63	70	60.80	44	46	38.60	29	0.27	0.32
50x 40	136	63	70	60.80	55	57	48.70	18	0.28	0.33
65x 40	145	61	87	76.60	55	57	48.70	29	0.38	0.44
65x 50	149	61	87	76.60	63	70	60.80	25	0.40	0.47
75x 40	153	64	102	89.60	55	57	48.70	34	0.45	0.50
75x 50	165	64	102	89.60	63	70	60.80	38	0.50	0.55
75x 65	159	64	102	89.60	61	87	76.60	34	0.58	0.64
100x 75	190	84	130	114.70	64	102	89.60	42	0.86	0.96
125x100	229	104	157	140.85	84	130	114.70	41	1.40	1.55
150x100	295	132	186	166.00	84	130	114.70	79	2.40	2.82
150x125	272	132	186	166.00	104	157	140.85	36	2.50	2.93
200x150	356	145	240	217.00	132	188	166.00	79	5.40	6.36
250x200	380	155	292	268.20	145	240	217.00	80	9.40	11.00

Notes: Size of 350 mm or over can also be manufactured. Please consult our nearest office.

PRODUCT MODEL CODE LIST

Type	Field	Model	Material	Standard	Size
F	*	*	U	1	***
⋮	⋮	⋮	⋮	⋮	⋮
F Flange	F SU G GU	T TS Flange Q Blind Flange	U U-PVC	1 JIS10K	013 13mm 300 300mm

TS Flange (JIS 10K Type)

PRODUCT MODEL CODE

SU	F	F	T	U	1	0	Size
GU	F	G	T	U	1	0	Size

13 – 125 mm

150 – 300 mm

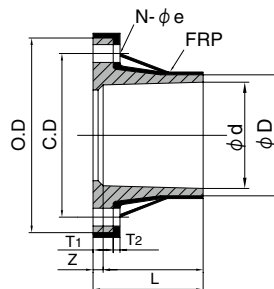

Dimensions Table

(Unit: mm)

Size	L	ℓ	Z	O.D	C.D	D	d	T ₁	T ₂		N-φ _e	Reference Weight (kg)	
									SU	GU		SU	GU
13	30.0	26	4.0	90	65	25.5	18.40	14	2	2.0	4-15	0.13	0.13
15	35.0	30	5.0	95	70	31.0	22.40	14	5	5.0	4-15	0.19	0.19
20	40.0	35	5.0	100	75	35.0	26.45	15	5	5.0	4-15	0.24	0.24
25	46.0	40	6.0	125	90	42.5	32.55	15	5	5.0	4-19	0.38	0.38
30	50.5	44	6.5	135	100	48.5	38.60	16	5	5.0	4-19	0.45	0.45
40	61.5	55	6.5	140	105	60.5	48.70	16	6	6.0	4-19	0.53	0.53
50	71.0	63	8.0	155	120	73.0	60.80	20	8	8.0	4-19	0.81	0.81
65	70.0	61	9.0	175	140	90.0	76.60	22	8	8.0	4-19	1.10	1.10
75	73.0	64	9.0	185	150	105.0	89.60	22	8	8.0	8-19	1.20	1.20
100	93.0	84	9.0	210	175	131.0	114.7	22	10	10.0	8-19	1.70	1.70
125	114.0	104	10.0	250	210	158.0	140.85	24	12	12.0	8-23	2.70	2.70
150	142.0	132	10.0	280	240	185.0	166.0	26	2	3.5	8-23	2.80	3.40
200	156.0	145	11.0	330	290	238.0	217.0	28	2	3.5	12-23	3.90	4.60
250	167.0	155	12.0	400	355	289.0	268.2	30	2	3.5	12-25	5.60	6.60
300	167.0	155	12.0	445	400	341.0	318.7	30	2	4.3	16-25	7.50	9.00

Notes: Size of 350 mm or over and welding flange modification are also available. Please consult a near-by sales office.

Blind Flange (JIS 10K Type)

PRODUCT MODEL CODE

SU	F	F	Q	U	1	0	Size
GU	F	G	Q	U	1	0	Size

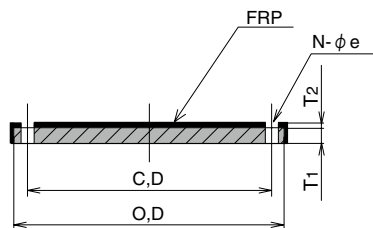

Dimensions Table

(Unit: mm)

(Unit: mm)

Size	O.D	C.D	T ₁		T ₂		N-φ _e	Reference Weight (kg)		Size	O.D	C.D	T ₁		T ₂		N-φ _e	Reference Weight (kg)	
			SU	GU	SU	GU		SU	GU				SU	GU	SU	GU			
13	90	65	12	12	2.5	3	4-15	0.14	0.15	125	250	210	20	20	3.0	6	8-23	1.75	2.02
15	95	70	12	12	2.5	3	4-15	0.16	0.17	150	280	240	22	22	4.0	8	8-23	2.52	2.99
20	100	75	14	14	2.5	3	4-15	0.20	0.21	200	330	290	22	22	5.0	10	12-23	3.64	4.45
25	125	90	14	14	2.5	3	4-19	0.31	0.32	250	400	355	24	24	7.0	13	12-25	6.26	7.70
30	135	100	16	16	2.5	3	4-19	0.41	0.43	300	445	400	24	24	9.0	15	16-25	8.30	10.50
40	140	105	16	16	2.5	3	4-19	0.45	0.46	350	490	445	25	20	13.0	25	16-25	12.00	15.00
50	155	120	16	16	2.5	3	4-19	0.55	0.57	400	560	510	25	20	13.0	25	16-27	16.00	19.50
65	175	140	18	18	2.5	3	4-19	0.78	0.81	450	620	565	25	20	13.0	25	20-27	19.00	24.00
75	185	150	18	18	2.5	3	8-19	0.84	0.87	500	675	620	25	20	15.0	25	20-27	24.50	28.50
100	210	175	18	18	2.5	5	8-19	1.10	1.27	600	795	730	30	20	15.0	30	24-33	37.00	43.50

Installation Procedure

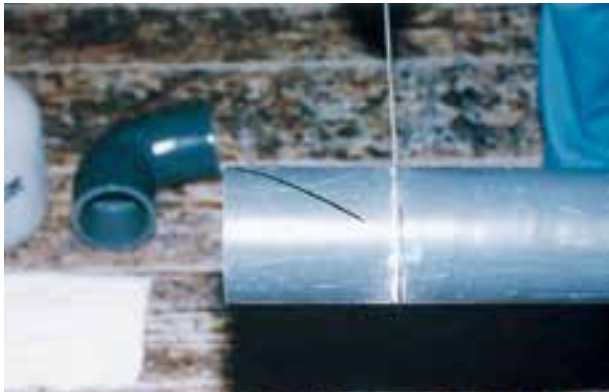

- 1** After cutting the pipe with specified length, put a gauge line along the perimeter of the pipe and put incision in the circumference direction spirally with a saw, etc.



- 2** Heat evenly by a propane gas burner.



- 3** Pinch the FRP layer with pliers, etc. and peel it off.



- 4** Finish the FRP peeled part with a sand paper, etc., chamfer the tip 45°, and apply adhesive evenly on the connection part of pipe and fitting.



- 5** Insert into fitting using a lever block, etc.



- 6** Remove the protruded adhesive from the connection end and weld.



7 After applying primer, fill the area where it has a level difference in joints and the corner part with the mixture made by adding and mixing the hardener with the volume ratio of 1 to 2% against Q Coat Putty little by little, and then finish smoothly using a spatula.



8 Add hardener to polyester resin and apply it on the connection part with a brush or roller to impregnate the polyester resin into the glass fibers to build specified lamination.

■ Mixing Ratio and Curing Time

(Volume ratio against polyester resin 100)

Outside Temperature	Hardener	
	1%	2%
10°C	48 minutes	15 minutes
20°C	22 minutes	–
30°C	9 minutes	–

Piping Support Procedure

■ Support Intervals

Install supports on the straight part by referring to the intervals in the following table.

SU type

(Unit: m)

Size \ Temperature	13 – 25 mm	30 – 50 mm	65 – 100 mm	125 – 150 mm	200 – 250 mm	300 – 400 mm	450 – 500 mm	600mm
20°C	1.0	1.5	2.0	2.25	2.5	2.75	3.0	3.5
60°C	1.0	1.25	1.5	1.75	2.0	2.25	2.5	2.75
90°C	1.0	1.25	1.25	1.5	1.75	1.75	2.0	2.0

GU Type

(Unit: m)

Size \ Temperature	13 – 25 mm	30 – 40 mm	50 – 65 mm	75 – 125 mm	150 – 250 mm	300 – 350 mm	400 – 500 mm	600mm
20°C	1.0	1.5	2.0	2.25	2.75	2.75	3.0	3.5
60°C	1.0	1.25	1.75	2.0	2.5	2.5	2.75	3.25
95°C	1.0	1.25	1.5	1.75	2.0	2.0	2.75	3.0

For supporting the bending parts and other areas, refer to the separate Technical Document "ASAHI AV® AV Pipe Installation Procedure (AV-T-018-J)."

Maintenance Materials for AV Pipe Installation

Product Name		Use	Shipment Unit	
AV Cement No.88 (Size of 150 mm or less) AV Cement No.62 (Size of 200 mm or more)		Connects PVC pipe with FRP removed and fitting.	250 g/can 500 g/can 1 kg (No.62)	
Welding rod (φ3, φ4)		Welds the small end of bonded pipe fitting.	1 kg/box	
Primer (UA solution, UB solution)		Enhances the bonding of PVC and FRP.	500 g/can	
Q Coat Putty		Fills a level difference between pipe and fitting and enhances the strength of connected/welded part.	1kg/can	
Polyester resin		Impregnates resin to glass fibers when laminating them on the top layer of connected pipe fitting.	500 g/can	
Hardener		Hardens Q Coat Putty and polyester resin.	500 g/can	
Glass fibers	SU type	Glass Cloth (GC)	Laminates on the top layer of connected pipe/fitting for reinforcement. (Type of glass fibers differs by size.)	m/lap
		Surface Cloth (SC)		
	GU Type	Glass Cloth (GC)		
		Mat (M)		
		Roving Cloth (WR)		
Surface Cloth (SC)				
Accelerator (Required when installing at overseas.)		Accelerates hardening.	1kg/can	
Acetone		Cleans the connection part.	500 g/can	

Maintenance materials above are required for AV pipe field installation. Maintenance materials are for AV pipe only. Do not use them for other purposes. For required quantity of maintenance materials, please consult our nearest office.

Precautions for Storing and Handling of Maintenance Materials

1) Precautions for storage

Be cautious in storage as maintenance materials contain hazardous materials. Display of the hazardous materials and avoid flammables.

2) Precautions for handling

- ① Never mix hardener and accelerator directly as it could cause an explosive reaction and create an extremely dangerous condition.
- ② Never put polyester resin, accelerator, hardener, primer, Q Coat Putty, acetone and adhesive close to fire as they are flammable.
- ③ Wear protection gloves, protection glasses and organic gas mask when working.
- ④ Do not apply an excessive impact to hardener.
- ⑤ After using maintenance materials, put a lid and store in a hazardous material storage place.
- ⑥ For used containers, punch a hole at the bottom of the container and dispose according to the local disposal standard.
- ⑦ If maintenance materials catch a fire, distinguish by using powder and carbon dioxide fire extinguisher.
- ⑧ If polyester resin, accelerator, hardener, primer, acetone or adhesive leaks, absorb it using an absorber and wipe off with a cloth immediately.
- ⑨ When handling maintenance materials excluding welding rod, never touch or pull with bare hands.
- ⑩ If toxic conditions caused by maintenance materials are seen, lay in a breezy area with the head lower than the legs and consult a doctor immediately.
- ⑪ In case of contacting with the eyes by mistake, rinse the eyes with clean water immediately for more than 30 minutes and consult a doctor immediately.

Piping Support Hardware

Be cautious of the following points when providing support to piping.

- Use a type that can bear the total weight of pipe, fluid inside the pipe and heat insulator.
- Be fully cautious about excessive tightening that could flatten piping.
- For support hardware to be used for piping fixation, use the following support hardware and make sure to provide a buffer with a rubber seat, etc.

Size	Support Hardware to be Used
30 mm or less	U-bolt, U-band
40 – 125 mm	U-band
150mm or more	U Band with Pipe Lower Support Saddle

① Piping U-Band 40 – 125 mm

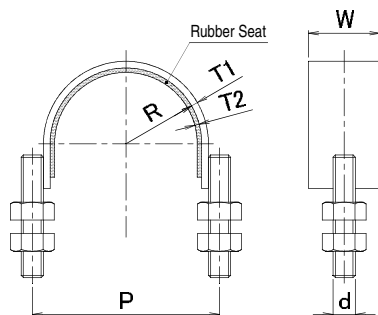

Size (mm)	SU						GU					
	d	R	P	W	T ₁	T ₂	d	R	P	W	T ₁	T ₂
40	M10	28	72	32	3	2	M10	28	72	32	3	2
50	M10	34	84	32	3	2	M10	36	88	32	3	2
65	M10	42	100	32	3	2	M10	44	104	32	3	2
75	M10	49	114	32	3	2	M10	51	118	32	3	2
100	M12	62	145	32	4.5	3	M12	64	149	32	4.5	3
125	M12	76	173	32	4.5	3	M12	77	175	32	4.5	3

For fitting materials, refer to the separate Technical Document "ASAHI AV Pipe Installation Procedure (AV-T-018-J)."

② Piping U-Band 150 – 300 mm

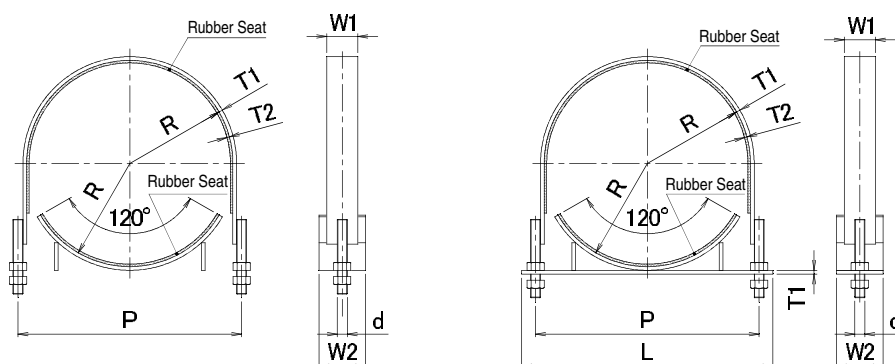

Saddle Weld Installation Type

Saddle Bolt Installation Type

Size (mm)	SU								GU							
	d	R	P	L	W ₁	W ₂	T ₁	T ₂	d	R	P	L	W ₁	W ₂	T ₁	T ₂
150	M12	89	199	250	38	50	4.5	3	M12	91	203	250	38	50	4.5	3
200	M12	114	249	300	38	50	4.5	3	M12	117	255	310	38	50	4.5	3
250	M12	140	301	350	38	50	4.5	3	M12	142	305	360	38	50	4.5	3
300	M16	166	360	410	50	75	6	4	M16	169	366	420	50	75	6	4

For fitting materials, refer to the separate Technical Document "ASAHI AV Pipe Installation Procedure (AV-T-018-J)."

Double Contained Pipe & Fittings

Overview of Double Contained Pipe	P.124
Double Contained Pipe	P.128
Double Contained Fittings	P.130
Thermal Pipe & Fittings	P.132
Technical Document	P.133

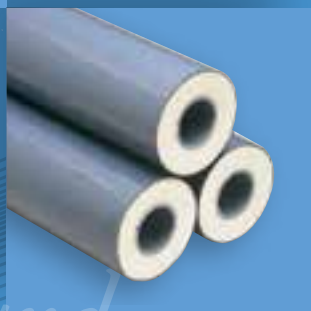
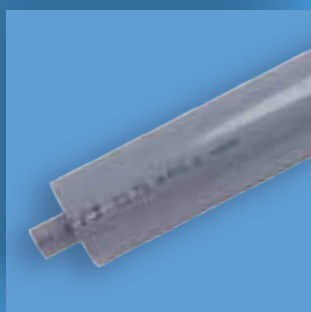

Safeguard

Double Contained Pipe

■ Overview

Double contained pipes are products of inner pipe (actual pipe) and outer pipe (protection pipe) combined together. With this structure, even if liquid leaks due to breakage of the inner pipe, the fluid is received by the outer pipe and scattering or leakage to outside can be prevented. You can identify a leakage directly and recover immediately by using transparent PVC pipe for outer pipe. Double contained pipes are effective for safety and environmental measures.

■ Revisions of the Water Pollution Prevention Act

- Creation of a System Effective for Prevention of Underground Water Contamination in Advance -(Enforcement date on June 1, 2012)

Law to revise part of the Water Pollution Prevention Act was enacted on June 14, 2011, promulgated on June 22, 2011, and enforced on June 1, 2012. Based on this law, new regulations are added to this Act **to regulate the installers of facilities using and storing hazardous substances (*1) to follow the standard for structure, equipment and use method of underground penetration prevention, conduct regular inspections, and keep records of the results.**

(*1) Hazardous substances subject to the regulations are in total of 28 items (as of June 2013) regulated in Article 2 of the Ordinance of Water Pollution Act such as cadmium, lead and trichloroethylene.

■ Measures (Effective Use of Double Contained Pipe)

Piping, etc. accompanied with the facility itself (Above ground facilities)

It is to prevent leakage to the floor surface, etc. by preventing leakage of hazardous materials from piping, etc. or **checking any leakage easily**. Because of this, it shall be a material/structure required for prevention of leakage from piping, etc. or a piping layout that is **easy to check any leakage visually**. In both cases, it shall be that any abnormality or leakage can be easily checked visually in regular inspections. Piping, etc. includes the piping main unit, fittings, flanges, valves and pump equipment where water containing hazardous materials would flow.

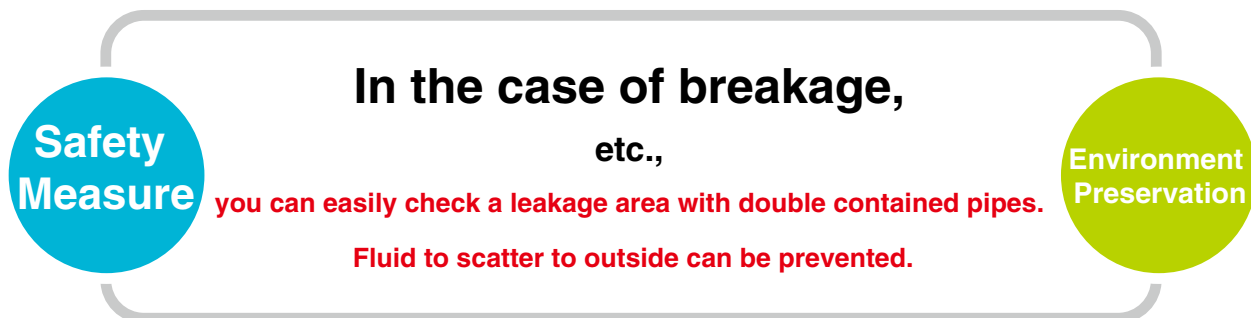

Features and Structure

1. Chemical Scattering Prevention

Making piping the dual design prevents chemical solutions from outflowing to outside even when the inner pipe is damaged, etc. Outer pipe is designed to withstand the full capacity (non pressure).

2. Visual Inspection is Feasible (Outer Pipe Transparent PVC)

Making outer pipe transparent PVC makes visual inspection done easily. Transparent PVC is available to the size of 200 mm (inner pipe 100 mm).

3. Expansion Measure (Elastic Slide Pipe)

Expansion/contraction amounts of outer pipe (outside temperature) and inner pipe (fluid temperature) are different. Inner pipe and outer pipe of **ASAHI** double contained pipes are independent to each other (not fixed), and expansion/contraction is absorbed with the outer pipe of elastic slide pipe.

Basic Structure

■ Inner pipe is not connected to outer pipe and moves and expands/contracts freely inside outer pipe.



Inner Pipe Outer Pipe



Elastic Slide Pipe

■ Elastic slide pipe absorbs heat expansion/contraction of outer pipe caused by outside temperature fluctuation, etc.

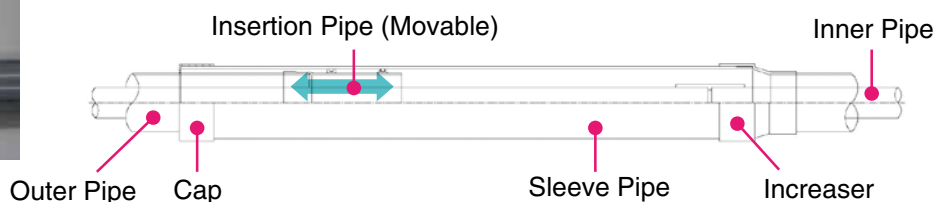

Installation Procedure

■ Piping installation shall be done in the order of inner pipe and outer pipe.



Product Lineup

■ Inner pipe can be selected based on conditions of chemical solution.

[Inner Pipe] Size 16 – 150 mm U-PVC, HI-PVC, High Purity PVC

[Outer Pipe] Size 65 – 250 mm U-PVC (65 – 250 mm), Transparent PVC (65 – 200 mm)

Lineup and Piping Example

Double Contained Pipe/Fittings Available Size

Size Inner Pipe x Outer Pipe (Unit: mm)	Piping Material				
	Inner Pipe (VP) Pipe & Fittings	Outer Pipe (VU Equivalent)			
		Pipe	Fitting		
16 x 65	U-PVC HI-PVC High Purity PVC	U-PVC Transparent PVC			
20 x 65					
25 x 75					
40 x 75					
50 x 100					
65 x 125					
75 x 150					
100 x 200				U-PVC	
125 x 250					
150 x 250					

* It may be U-PVC (Gray) specification depending on type of product. For details, refer to respective product standards.

Double Contained Pipe & Fittings Lineup

- ① Pipe
- ② Pipe (For Inner Pipe Fixing)
- ③ Elastic Slide Pipe
- ④ Elbow
- ⑤ Elbow (With Drain)
- ⑥ Tee
- ⑦ Tee (With Drain)
- ⑧ End Cap
- ⑨ Splash Panel
- * Guide Panel

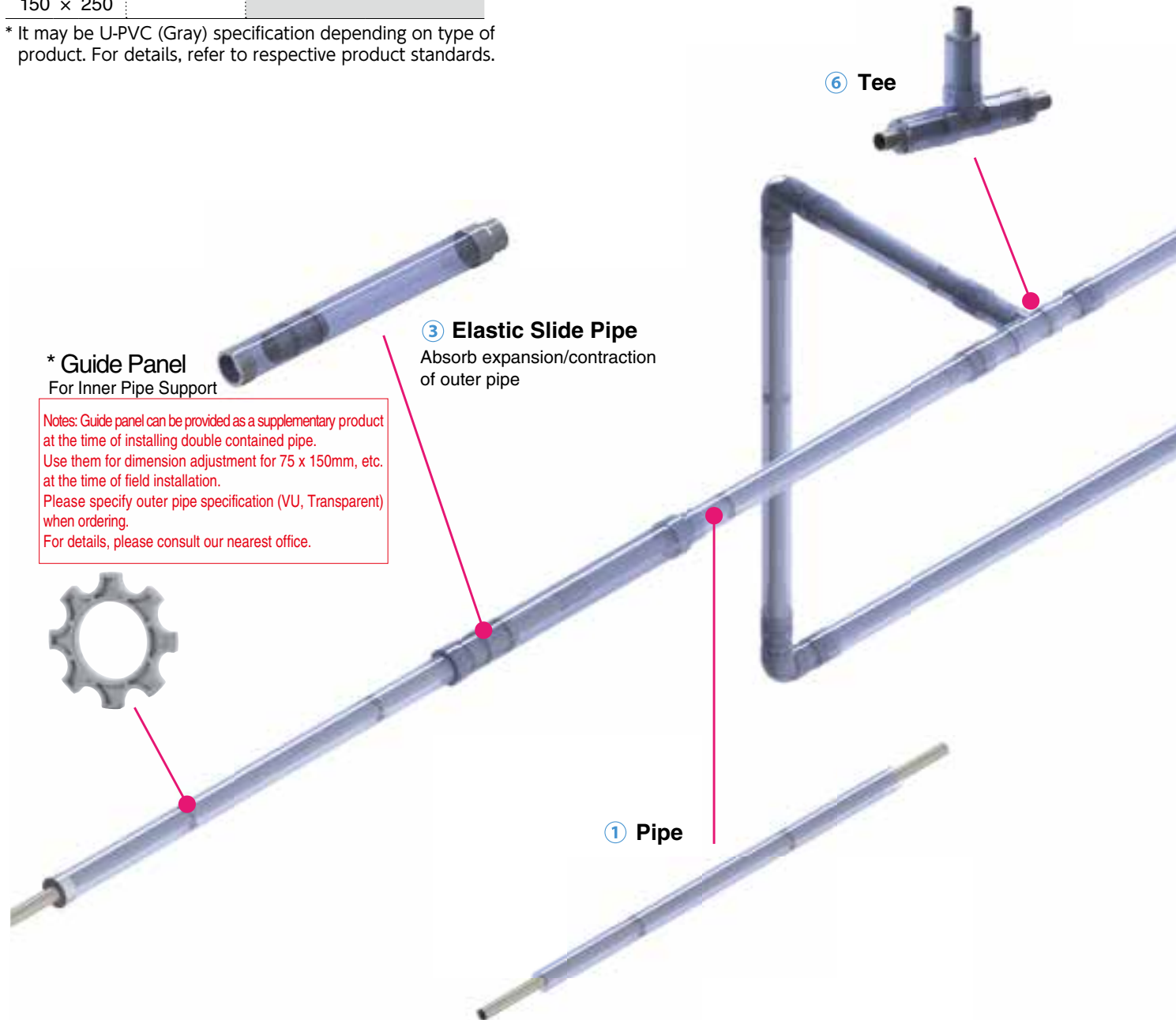



- ✓ Prevention of Scattering to Outside of Piping
- ✓ Prevention of Environment Pollution
- ✓ Safety Measure of Overhead Piping
- Piping crossing between buildings
- Also effective product for prevention of human damages from leakage of ceiling piping, etc.

⑦ Tee (With Drain)



④ Elbow

⑨ Splash Panel

The material of O-ring used to dam the leaked fluid to outer pipe is EPDM



② Pipe (For Inner Pipe Fixing)

Use when the distance of vertical piping is long

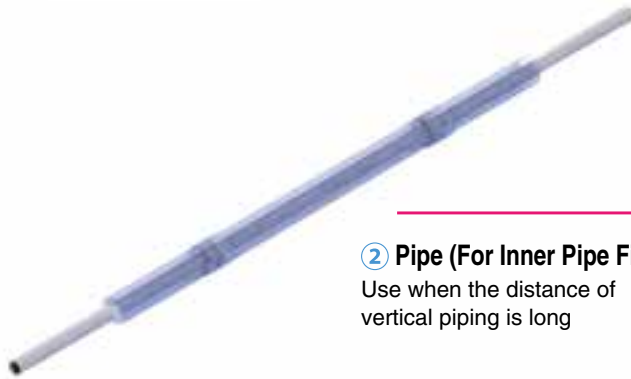

⑧ End Cap



Drain Valve

Install in front of splash panel in the case of sloped piping



⑤ Elbow (With Drain)



① Pipe

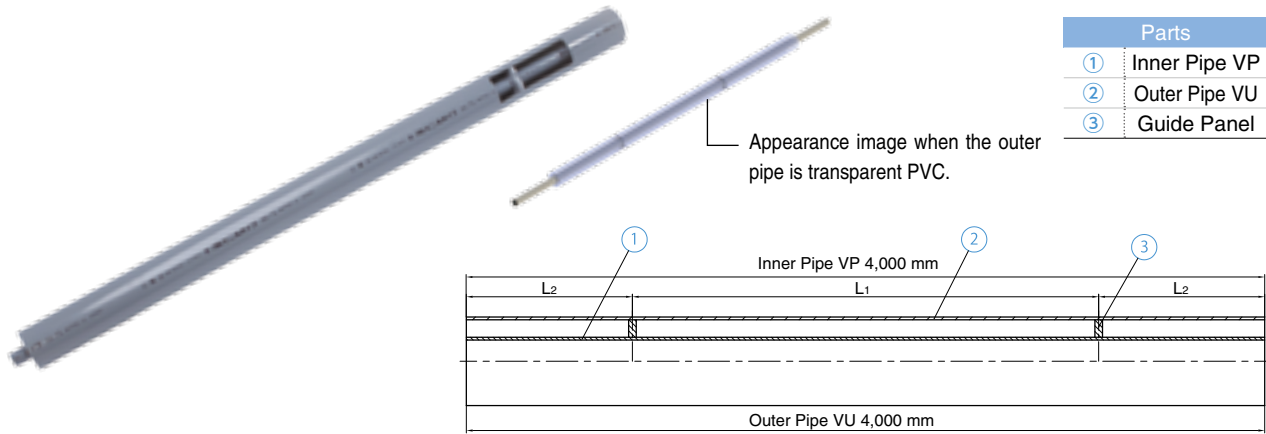

Parts	
①	Inner Pipe VP
②	Outer Pipe VU
③	Guide Panel

■ Dimensions Table

(Unit: mm)

Size Inner Pipe x Outer Pipe	Inner Pipe (VP)			Outer Pipe (VU)			Guide Panel		Weight (kg/set)	Outer Pipe Transparent PVC
	Size	Outer Diameter	Approximate Inner Diameter	Size	Outer Diameter	Approximate Inner Diameter	L ₁	L ₂		
16× 65	16	22	16	65	76	71	1300	700	4.4	○
20× 65	20	26	20	65	76	71	1300	700	4.6	○
25× 75	25	32	25	75	89	83	1300	700	6.6	○
40× 75	40	48	40	75	89	83	2000	1000	7.9	○
50×100	50	60	51	100	114	107	2000	1000	11.6	○
65×125	65	76	67	125	140	131	2000	1000	17.0	○
75×150	75	89	77	150	165	154 (155)	2000	1000	24.9	○
100×200	100	114	100	200	216	202	2000	1000	40.5	○
125×250	125	140	125	250	267	250	2000	1000	57.8	—
150×250	150	165	146	250	267	250	2000	1000	66.7	—

Notes: Approximate inner diameter will be () when the outer pipe is transparent PVC for 75 x 150mm.

② Pipe (For Inner Pipe Fixing)

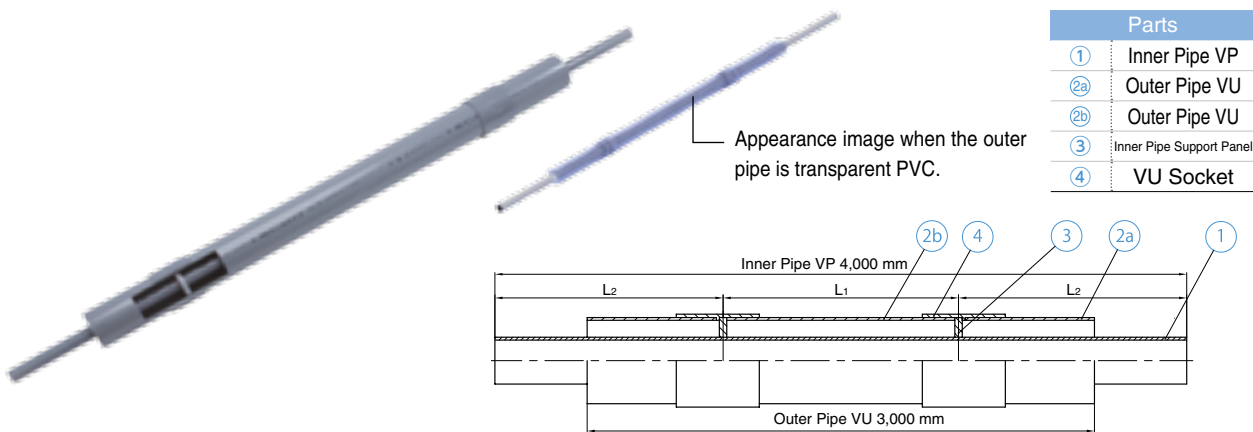

Parts	
①	Inner Pipe VP
②a	Outer Pipe VU
②b	Outer Pipe VU
③	Inner Pipe Support Panel
④	VU Socket

■ Dimensions Table

(Unit: mm)

Size Inner Pipe x Outer Pipe	Inner Pipe (VP)			Outer Pipe (VU)			Inner Pipe Support Panel		Weight (kg/set)	Outer Pipe Transparent PVC
	Size	Outer Diameter	Approximate Inner Diameter	Size	Outer Diameter	Approximate Inner Diameter	L ₁	L ₂		
16× 65	16	22	16	65	76	71	2000	1000	3.8	○
20× 65	20	26	20	65	76	71	2000	1000	4.0	○
25× 75	25	32	25	75	89	83	2000	1000	5.7	○
40× 75	40	48	40	75	89	83	2000	1000	7.0	○
50×100	50	60	51	100	114	107	2000	1000	10.5	○
65×125	65	76	67	125	140	131	2000	1000	15.3	○**
75×150	75	89	77	150	165	154 (155)	2000	1000	22.7	○**
100×200	100	114	100	200	216	202	2000	1000	36.8	○**
125×250	125	140	125	250	267	250	2000	1000	53.0	—
150×250	150	165	146	250	267	250	2000	1000	62.0	—

Notes: 1. Approximate inner diameter will be () when the outer pipe is transparent PVC for 75 x 150mm.

2. * ④ UV Socket is not transparent.

③ Elastic Slide Pipe

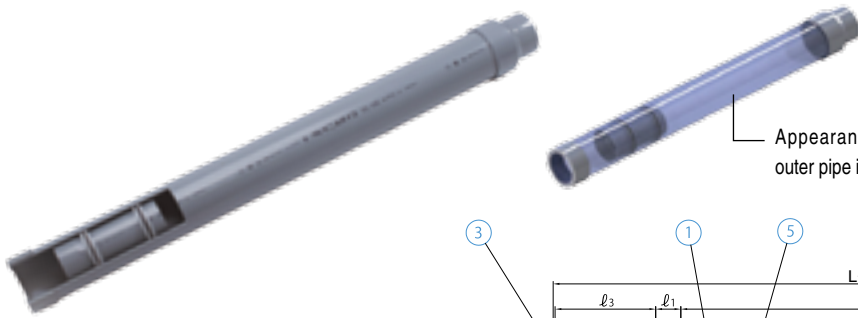

Appearance image when the outer pipe is transparent PVC.

Parts	
①	Insertion Pipe VU
②	Sleeve Pipe VU
③	VU Cap
④	VU Increaser
⑤	O-Ring

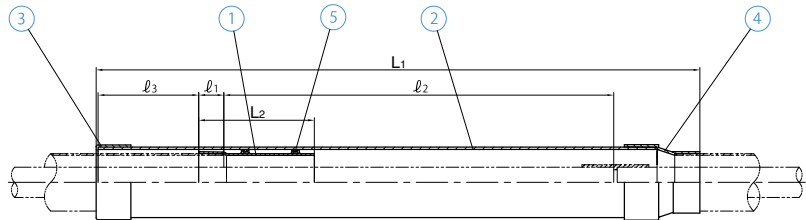

* ② Sleeve pipe and ④ VU increaser are connected on site.
* Elastic slide pipe does not have inner pipe and outer pipe.

■ Dimensions Table

(Unit: mm)

Size		L ₁	L ₂	l ₁	l ₂	l ₃ (Min.)	Weight (kg/set)	Sleeve Pipe Transparent PVC
Inner Pipe x Outer Pipe	Sleeve Pipe							
16x 65	100	1000	210	35	630	200	2.4	○
20x 65	100	1000	210	35	630	200	2.4	○
25x 75	100	1200	220	40	800	200	2.7	○
40x 75	100	1200	220	40	800	200	2.7	○
50x100	125	1300	230	50	800	200	4.5	○
65x125	150	1300	250	65	820	200	6.7	○
75x150	200	1400	280	80	850	200	12.2	○
100x200	250	1500	300	110	900	200	19.1	—
125x250	300	1700	320	130	940	200	29.7	—
150x250	300	1700	320	130	940	200	29.7	—

Notes: 1. When the outer pipe is transparent PVC, ① Insertion Pipe VU, ③ VU Increaser and ④ UV Cap are not transparent.
2. O-ring is EPDM.

Movement image of elastic slide pipe

The insertion pipe moves inside the sleeve pipe of the elastic slide pipe in conjunction with expansion/contraction of the outer pipe.

Outer pipe is contracted (insertion pipe went backward).

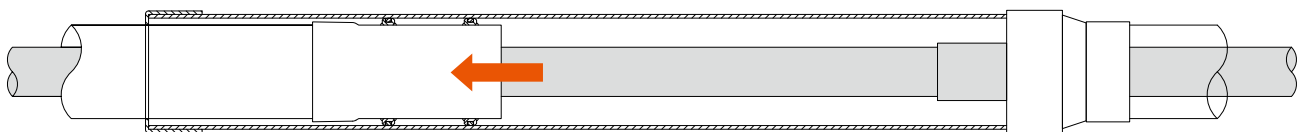

Outer pipe is expanded (insertion pipe went forward).

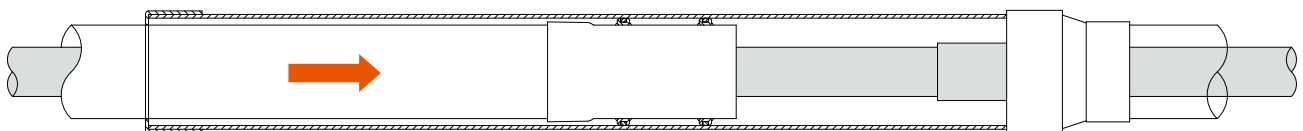

Precautions for Installation of Elastic Slide Pipe

- Take the product out from package immediately before installation.
- Avoid attachment of foreign objects of sand and chips, etc. to insertion pipe and sleeve pipe.
- Silicon grease is already applied on O-ring of insertion pipe. If it is difficult to insert into sleeve pipe when adjusting the position of insertion pipe, spray water into sleeve pipe with a spray gun or apply AV lubricant (separately sold). Never use a solvent-base grease.
- If position will be adjusted by inserting into sleeve pipe after connecting insertion pipe, avoid pulling the connection part forcibly.

④ Elbow

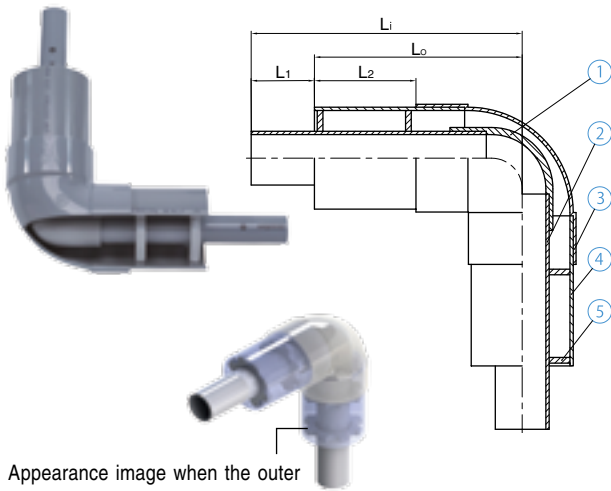

Appearance image when the outer pipe is transparent PVC.

Parts			
①	TS Elbow	④	Outer Pipe VU
②	Inner Pipe VP	⑤	Guide Panel
③	VU Elbow		

■ Dimensions Table (Unit: mm)

Size Inner Pipe x Outer Pipe	Li	L0	L1	L2	Weight (kg/set)	Outer Pipe Transparent PVC
16x 65	230	150	80	73	0.6	○
20x 65	235	150	85	73	0.7	○
25x 75	262	172	90	84	1.0	○
40x 75	277	172	105	84	1.3	○
50x100	329	217	112	105	2.3	○
65x125	385	275	110	135	3.9	—
75x150	446	333	113	165	6.6	—
100x200	574	440	134	215	13.2	—
125x250	691	537	154	266	21.7	—
150x250	719	537	182	266	26.2	—

Notes: 1. When the outer pipe is transparent PVC, ⑤ Guide Panel is not transparent.

⑤ Elbow (With Drain)

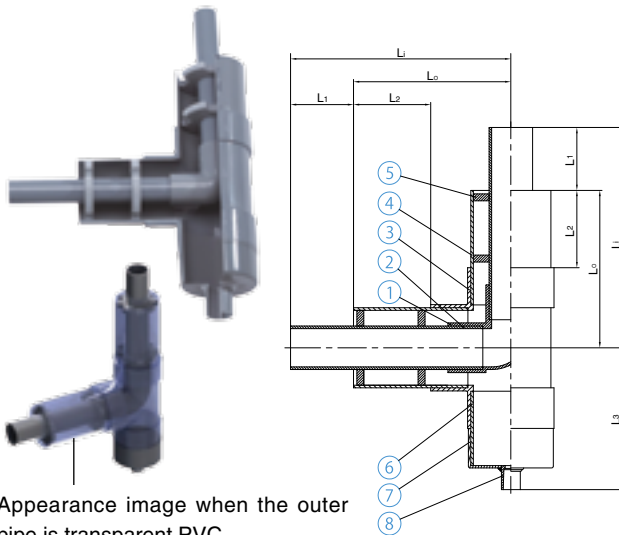

Appearance image when the outer pipe is transparent PVC.

Parts			
①	TS Elbow	⑤	Guide Panel
②	Inner Pipe VP	⑥	VU Pipe (Drain part)
③	VU90°Y	⑦	VU Cap
④	Outer Pipe VU	⑧	TS Socket 20 mm

■ Dimensions Table (Unit: mm)

Size Inner Pipe x Outer Pipe	Li	L0	L1	L2	L3	Weight (kg/set)	Outer Pipe Transparent PVC
16x 65	225	150	80	73	154	0.8	○
20x 65	235	150	85	73	154	0.9	○
25x 75	262	172	90	84	170	1.3	○
40x 75	277	172	105	84	170	1.5	○
50x100	329	217	112	105	204	2.8	○
65x125	385	275	110	135	248	5.0	—
75x150	446	333	113	165	292	8.2	—
100x200	574	440	134	215	379	16.0	—
125x250	691	537	154	266	450	27.1	—
150x250	719	537	182	266	450	31.6	—

Notes: 1. When the outer pipe is transparent PVC, ⑤ Guide Panel, ⑥ VU Pipe (Drain part), ⑦ VU Cap and ⑧ TS Socket are not transparent.

⑥ Tee

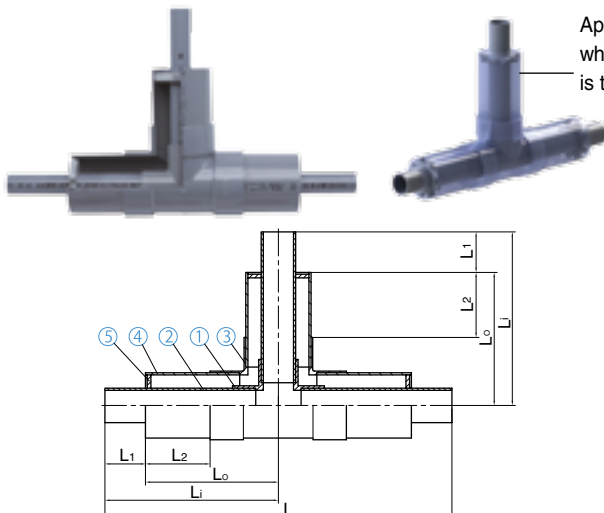

Appearance image when the outer pipe is transparent PVC.

Parts			
①	TS Tee	④	Outer Pipe VU
②	Inner Pipe VP	⑤	Guide Panel
③	VU90°Y		

■ Dimensions Table (Unit: mm)

Size Inner Pipe x Outer Pipe	L	Li	L0	L1	L2	Weight (kg/set)	Outer Pipe Transparent PVC
16x 65	460	230	150	80	73	0.8	○
20x 65	470	235	150	85	73	0.9	○
25x 75	524	262	172	90	84	1.4	○
40x 75	554	277	172	105	84	1.8	○
50x100	658	329	217	112	105	3.1	○
65x125	770	385	275	110	135	5.4	—
75x150	892	446	333	113	165	9.0	—
100x200	1148	574	440	134	215	17.6	—
125x250	1382	691	537	154	266	30.0	—
150x250	1438	719	537	182	266	37.0	—

Notes: 1. When the outer pipe is transparent PVC, ⑤ Guide Panel is not transparent.

⑦ Tee (With Drain) * Put on the outer pipe.

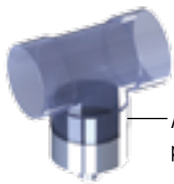

Appearance image when the outer pipe is transparent PVC.

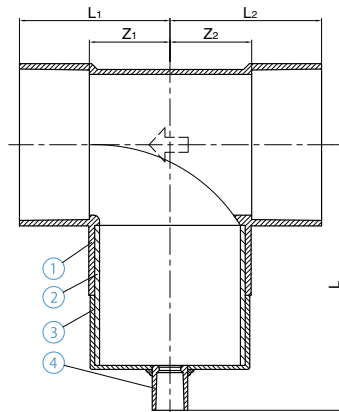

Parts			
①	VU90°Y	③	VU Cap
②	VU Pipe (Drain part)	④	TS Socket20 mm

■ Dimensions Table (Unit: mm)

Size Inner Pipe x Outer Pipe	L	L ₁	L ₂	Z ₁	Z ₂	Weight (kg/set)	Outer Pipe Transparent PVC
16x 65	153	77	78	42	43	0.4	○
20x 65	153	77	78	42	43	0.4	○
25x 75	169	88	89	48	49	0.5	○
40x 75	169	88	89	48	49	0.5	○
50x100	203	112	113	62	63	1.0	○
65x125	247	140	141	75	76	2.0	—
75x150	291	169	170	89	90	3.2	—
100x200	378	225	226	115	116	5.5	—
125x250	447	271	274	141	144	9.7	—
150x250	447	271	274	141	144	9.7	—

Notes: 1. When the outer pipe is transparent PVC, ③ VU Cap and ④ TS Socket (20 mm) are not transparent.

⑧ End Cap

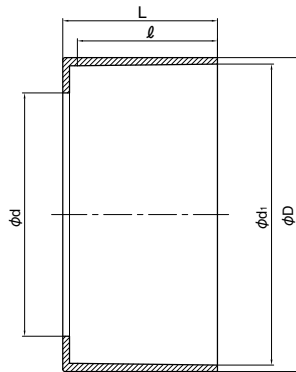

■ Dimensions Table (Unit: mm)

Size Inner Pipe x Outer Pipe	D	L	ℓ	d ₁	d	Weight (kg)
16x 65	81.5	37.5	35	76.40	23	0.1
20x 65	81.5	37.5	35	76.40	27	0.1
25x 75	94.5	42.5	40	89.45	33	0.1
40x 75	94.5	42.5	40	89.45	49	0.1
50x100	122.0	53.0	50	114.55	61	0.2
65x125	148.5	69.0	65	140.70	77	0.3
75x150	175.5	84.0	80	166.10	90	0.4
100x200	228.0	115.0	110	217.30	115	0.9
125x250	280.0	138.0	125	268.55	141	1.4
150x250	280.0	138.0	125	268.55	166	1.4

Notes: It is not transparent.

⑨ Splash Panel

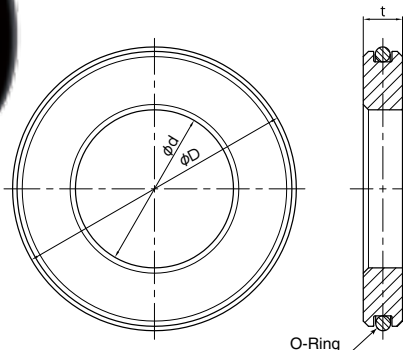

■ Dimensions Table (Unit: mm)

Size Inner Pipe x Outer Pipe	D	d	t	Weight (kg/set)
16x 65	71	22	15	0.07
20x 65	71	26	15	0.07
25x 75	83	32	15	0.09
40x 75	83	48	15	0.07
50x100	107	60	15	0.12
65x125	131	76	15	0.18
75x150	154 (155)	89	15	0.25
100x200	202	114	20	0.60
125x250	250	140	20	0.93
150x250	250	165	20	0.75

Notes: 1. It is not transparent. 2. O-ring is EPDM.

3. Outer pipe dimension for 75 x 150mm will be () when D is transparent PVC. Please specify outer pipe specification (VU, Transparent) of applicable size.

PRODUCT MODEL CODE LIST

■ Pipe

Type	Field	Material	Shape	Standard/Model	Size	Length
P	K	U	PP	JA	***	04
⋮	⋮	⋮	⋮	⋮	⋮	⋮
P Pipe	K Heat Insulating Pipe	U U-PVC	PP Straight Pipe	JA JIS A Type	025 25mm 300 300mm U-PVC	04 4m

■ Fittings

Type	Field	Material	Shape	Standard/Model	Size
T	K	U	**	JA	***
⋮	⋮	⋮	⋮	⋮	⋮
T Fitting	K Heat Insulating Fitting	U U-PVC	SO Socket 9L 90° Elbow 4L 45° Elbow TE Tee	JA JIS A Type	025 25mm 300 300mm

Thermal Pipe & Fittings

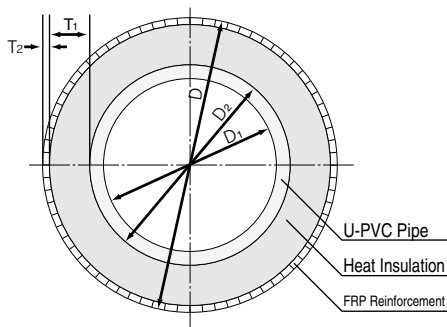

For Cold Regions

Specially made for cold regions by combining unplasticized polyvinyl chloride pipe and independent heat insulating material together and reinforcing its surface with FRP. There are various types of fittings available.

■ Dimensions Table

(Unit: mm)

Size	Unplasticized Polyvinyl Chloride Pipe Inner/Outer Diameter		Thickness		
	Inner Diameter D ₁	Outer Diameter D ₂	Heat Insulating Material T ₁	FRP T ₂	Heat Insulating Pipe Outer Diameter D
25	25	32	30	1	94
30	31	38	30	1	100
40	40	48	30	1	110
50	51	60	30	1	122
65	67	76	30	1	138
75	77	89	30	1	151
100	100	114	30	1	176
125	125	140	30	1	202
150	146	165	30	1	227
200	196	216	30	1	278
250	247	267	30	1	329
300	298	318	30	1	380

Technical Data

1. Basic Connection Procedure

Separate sockets (inner pipe TS socket, outer pipe VU socket) are required for connection.

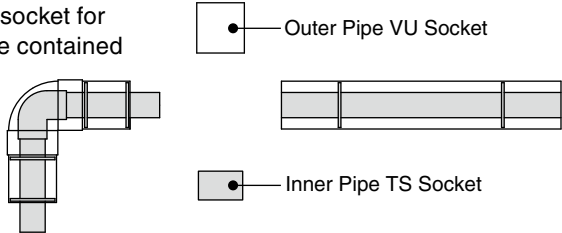
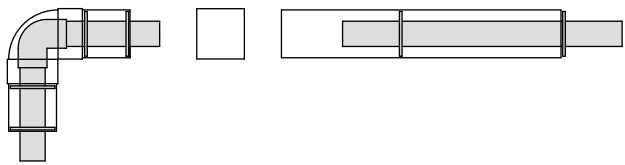
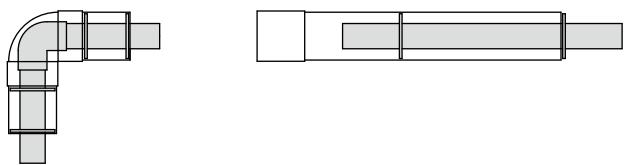
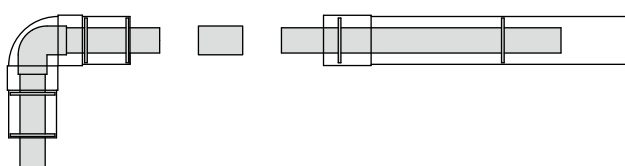
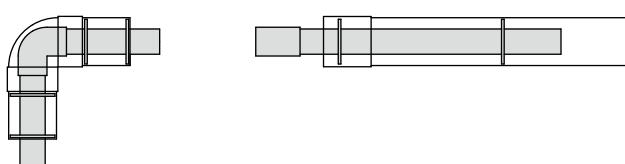
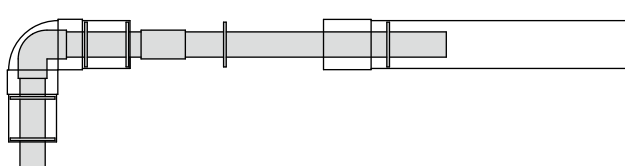
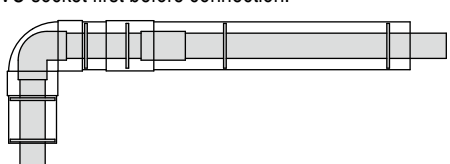
Steps	
<p>1) Component preparation</p>	<p>Prepare required socket for connecting double contained pipe and fitting.</p>  <p>● Outer Pipe VU Socket</p> <p>● Inner Pipe TS Socket</p>
<p>2) Outer pipe connection ① VU socket connection</p>	<p>① Slide inner pipe (backward) and thrust the connecting outer pipe.</p> 
<p>2) Connect VU socket and outer pipe.</p>	<p>② Connect VU socket and outer pipe.</p> 
<p>3) Inner pipe connection ① TS socket connection</p>	<p>① Slide pipe outer pipe (backward) and thrust the connecting inner pipe.</p> 
<p>② Connect TS socket and inner pipe.</p>	<p>② Connect TS socket and inner pipe.</p> 
<p>4) Inner pipe connection ② Inner-to-inner pipe (fitting) connection</p>	<p>Slide outer pipe (backward) and connect inner pipe with socket connected and other inner pipe.</p> 
<p>5) Outer pipe connection ② Outer-to-outer pipe (fitting) connection</p>	<p>Connect outer pipe with socket connected and other outer pipe. If the pipe is going to be extended further, do not forget to place VU socket first before connection.</p> 

2. Irregular Pipe Procedure (Dimension Adjustment)

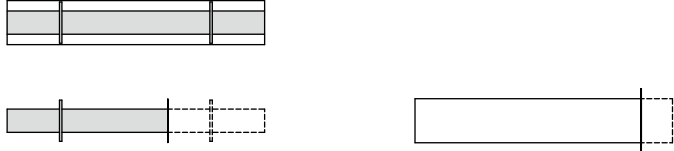
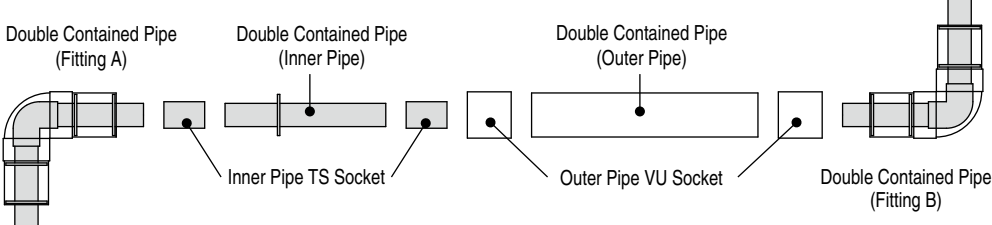
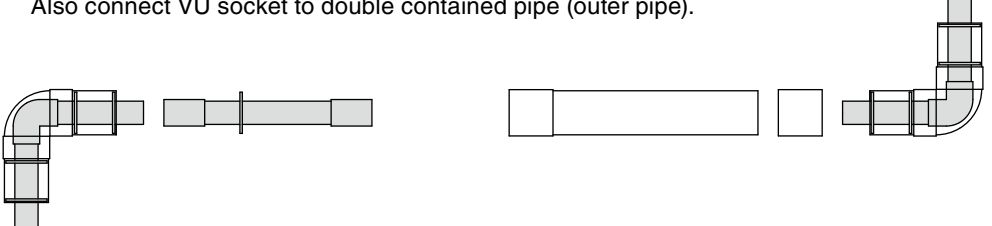
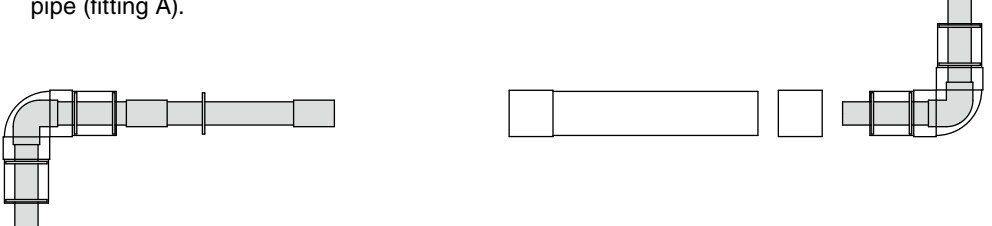
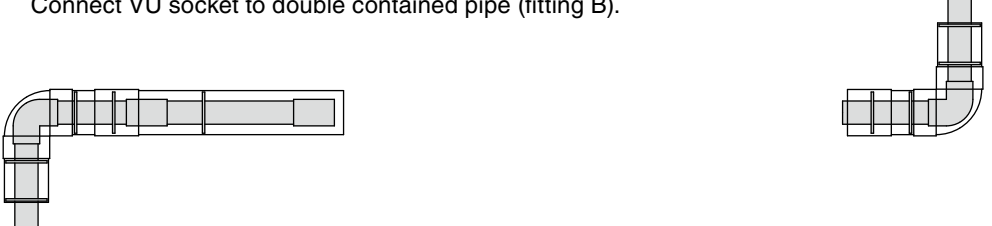
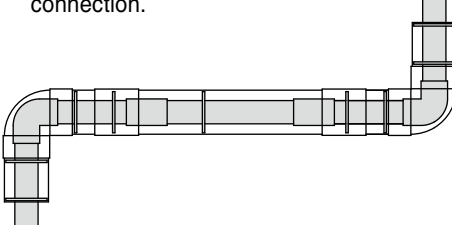
Steps	
1) Pipe cutting	<p>① Separate inner pipe and outer pipe and cut them to specified dimensions.</p> 
2) Component preparation	<p>② Prepare required socket for connecting the cut double contained pipe and fitting.</p> <p>Double Contained Pipe (Fitting A) Double Contained Pipe (Inner Pipe) Double Contained Pipe (Outer Pipe) Double Contained Pipe (Fitting B)</p> <p>Inner Pipe TS Socket Outer Pipe VU Socket</p> 
3) Inner/outer pipe connection Step ①	<p>③ Connect TS socket to double contained pipe (inner pipe). Also connect VU socket to double contained pipe (outer pipe).</p> 
4) Inner/outer pipe connection Step ②	<p>④ Connect double contained pipe (inner pipe) with TS socket connected to double contained pipe (fitting A).</p> 
5) Inner/outer pipe connection Step ③	<p>⑤ Connect double contained pipe (outer pipe) to double contained pipe (fitting A). Connect VU socket to double contained pipe (fitting B).</p> 
6) Inner/outer pipe connection Step ④	<p>⑥ Connect double contained pipe (fitting B) with socket connected. This will make simultaneous connection.</p> 

[Reference] Calculation of irregular pipe (required pipe length ℓ) dimensions

(When the dimension of elbow-to-elbow, elbow-to-tee and tee-to-tee is set to L)

Size		Required Pipe Length ℓ	
Inner Pipe	Outer Pipe	Inner Pipe	Outer Pipe
16	65	L- (460-7 \times TS Socket quantity)	L- (300-3 \times VU Socket quantity)
20	65	L- (470-7 \times TS Socket quantity)	L- (300-3 \times VU Socket quantity)
25	75	L- (524-7 \times TS Socket quantity)	L- (344-4 \times VU Socket quantity)
40	75	L- (554-7 \times TS Socket quantity)	L- (344-4 \times VU Socket quantity)
50	100	L- (658-7 \times TS Socket quantity)	L- (434-5 \times VU Socket quantity)
65	125	L- (770-23 \times TS Socket quantity)	L- (550-5 \times VU Socket quantity)
75	150	L- (892-27 \times TS Socket quantity)	L- (666-5 \times VU Socket quantity)
100	200	L- (1,148-32 \times TS Socket quantity)	L- (880-5 \times VU Socket quantity)
125	250	L- (1,382-32 \times TS Socket quantity)	L- (1,074-6 \times VU Socket quantity)
150	250	L- (1,438-36 \times TS Socket quantity)	L- (1,074-7 \times VU Socket quantity)

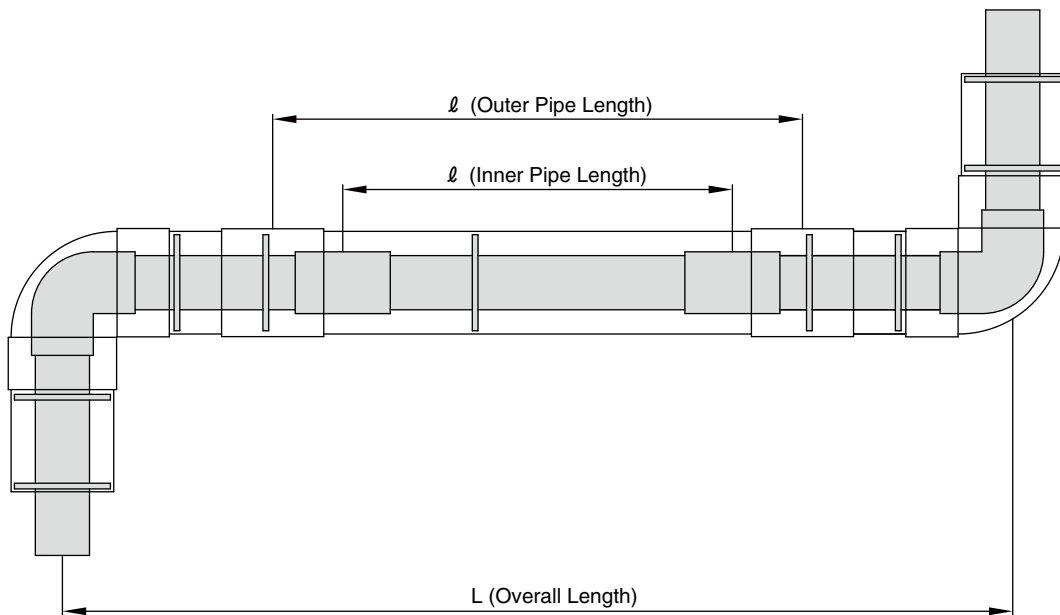

3. Elastic Slide Pipe Connection Procedure

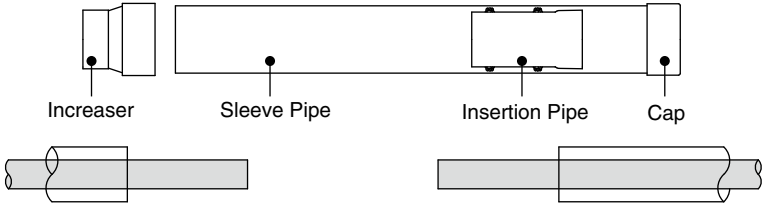
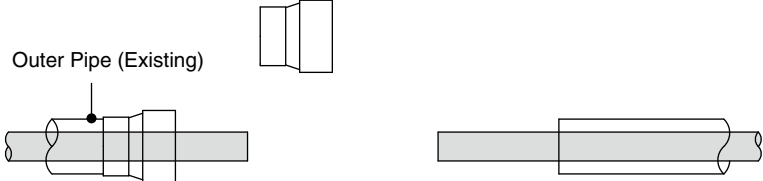
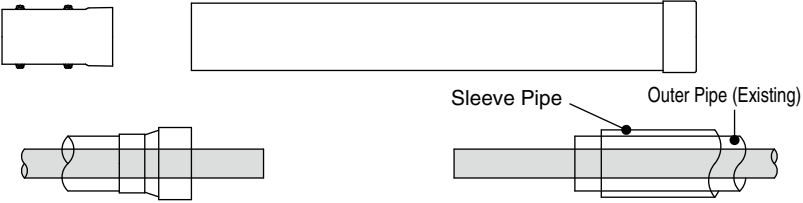
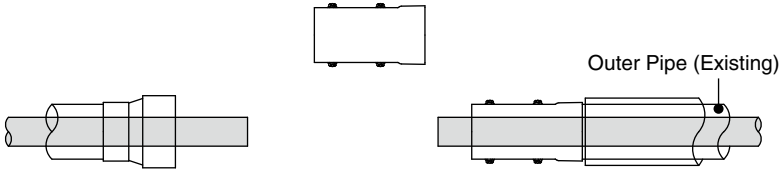
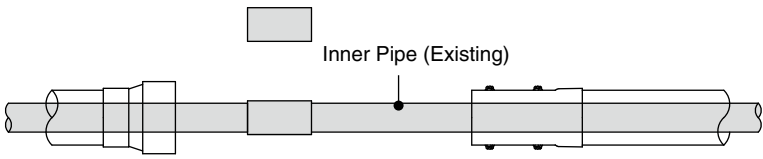
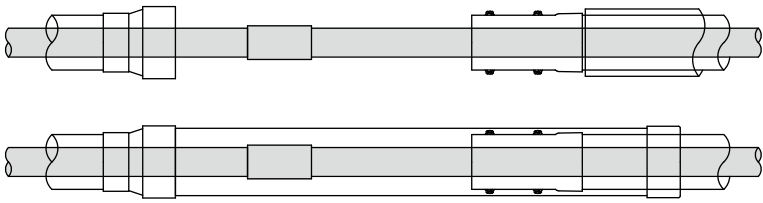
Steps	
1) Component preparation	<p>① Prepare required fitting for connection with elastic slide pipe.</p>  <p style="text-align: center;"> Increaser Sleeve Pipe Insertion Pipe Cap </p>
2) Increaser connection	<p>② Connect increaser to outer piper (existing).</p>  <p style="text-align: center;">Outer Pipe (Existing)</p>
3) Sleeve pipe insertion	<p>③ Insert sleeve pipe from cap side (hole in the center) and penetrate through outer pipe (existing).</p>  <p style="text-align: center;"> Sleeve Pipe Outer Pipe (Existing) </p>
4) Insertion pipe connection	<p>④ Insert insertion pipe and connect to outer piper (existing).</p>  <p style="text-align: center;">Outer Pipe (Existing)</p>
5) Inner pipe connection	<p>⑤ Connect inner piper (existing).</p>  <p style="text-align: center;">Inner Pipe (Existing)</p>
6) Sleeve pipe connection	<p>⑥ Connect sleeve pipe and increaser.</p> 

[Reference] Allowable extension/contraction amount and absorbable piping length of elastic slide pipe

Refer to the following for installation of elastic slide pipe.

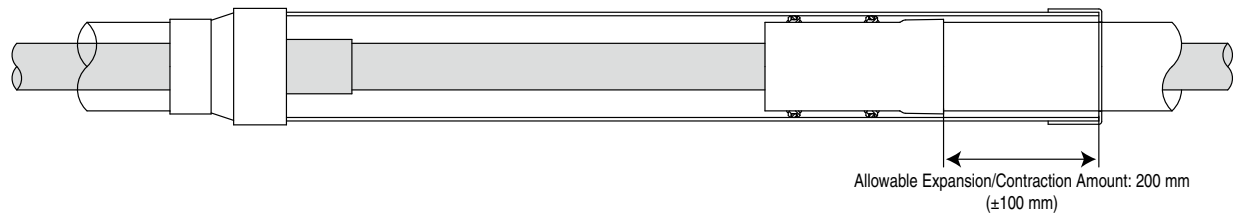

Absorbable piping length of elastic slide pipe per elastic slide pipe above is as follows.

Temperature Difference Δt (°C)	10	20	30	40
Absorbable Piping Length (m)	142	71	47	35

■ Installation Image of Elastic Slide Pipe

Elastic slide pipes are structured to absorb (single side absorption) expansion/contraction of outer pipe with specified piping length as shown in the following diagram.

Install necessary quantity of elastic slide pipes in consideration of piping straight length and absorbable piping length based on the table above.

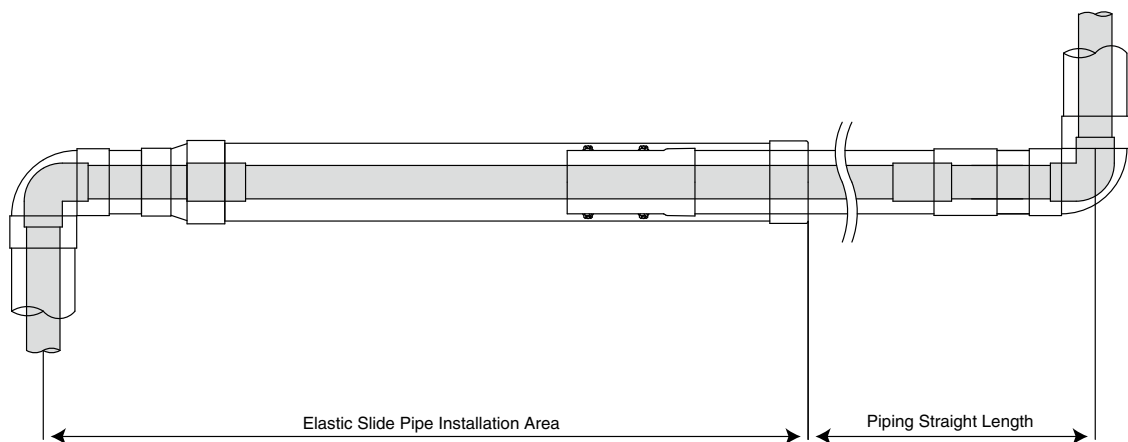

* Make sure to fix and support elastic slide pipes. Also provide support at specified intervals to avoid center misalignment with outer pipe.

4. Piping Support Method

1) Piping Support Intervals

Double contained pipe supports outer pipe and elastic slide pipe (sleeve pipe). Intervals differ by size.

Refer to the following for intervals. When installing support hardware, be cautious of not tightening nuts excessively.

Excessive tightening of support hardware may cause deformation, breakage and leakage (from O-ring, etc. of elastic slide pipe).

Use of double nuts or saddle band and utilization of level difference of fitting is an effective way to prevent excessive tightening.

Size (Outer Pipe)	Support Interval (Unit: m)		
	Temperature (°C)		
	to 20	to 40	to 60
VU65	0.9	0.9	0.8
VU80	1.0	1.0	0.9
VU100	1.1	1.2	1.0
VU125	1.2	1.2	1.1
VU150	1.3	1.3	1.3
VU200	1.5	1.5	1.4
VU250	1.7	1.6	1.6

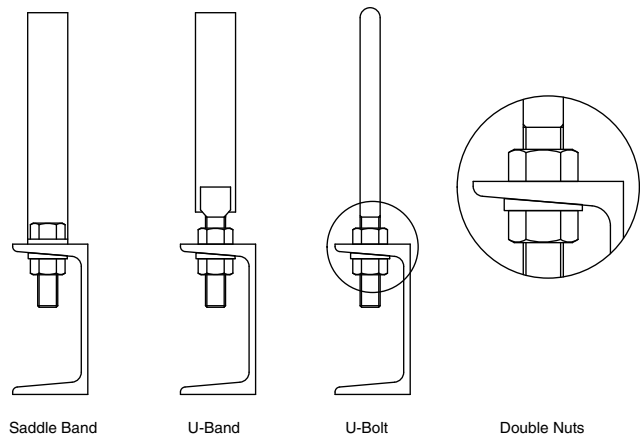

2) Fixation of Elastic Slide Pipe

For installation of elastic slide pipe, use a pipe platform, etc. as shown below and fix the pipe at a place where there is a level difference of fitting (increaser, end cap) part. At this time, use U-bolt or U-band as steady brace.

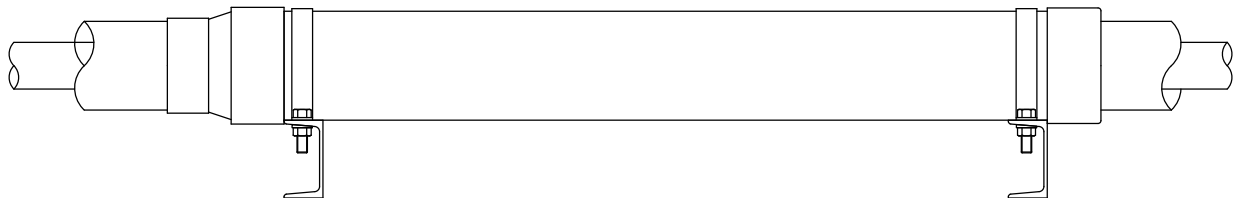

If providing support above is difficult, support the center of elastic slide pipe and support both ends of outer pipe.

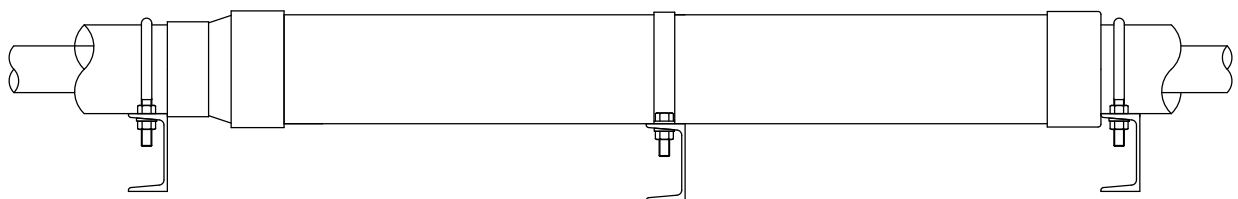

At this time, provide support for respective levels as pipe sizes differ between outer pipe and elastic slide pipe.

Inner Pipe	Outer Pipe	Elastic Slide Pipe (Sleeve Pipe)	Inner Pipe	Outer Pipe	Elastic Slide Pipe (Sleeve Pipe)
16	65	VU100	65	125	VU150
20	65	VU100	75	150	VU200
25	75	VU100	100	200	VU250
40	75	VU100	125	250	VU300
50	100	VU125	150	250	VU300

Continuous support which is to support the entire elastic slide pipe with angle or channel is also effective.

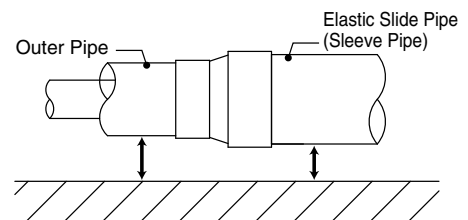

5. Drain Installation

The fluid flow from inner pipe to outer pipe needs to be drained rapidly and safely. For this purpose, install drains in the middle of piping. To be able to identify a leakage area, installing a drain every 20 m as shown in the following diagram is recommended. Marking on outer pipe where a splash panel is installed is useful. When piping is installed on slope, install drain valves on the down stream side.

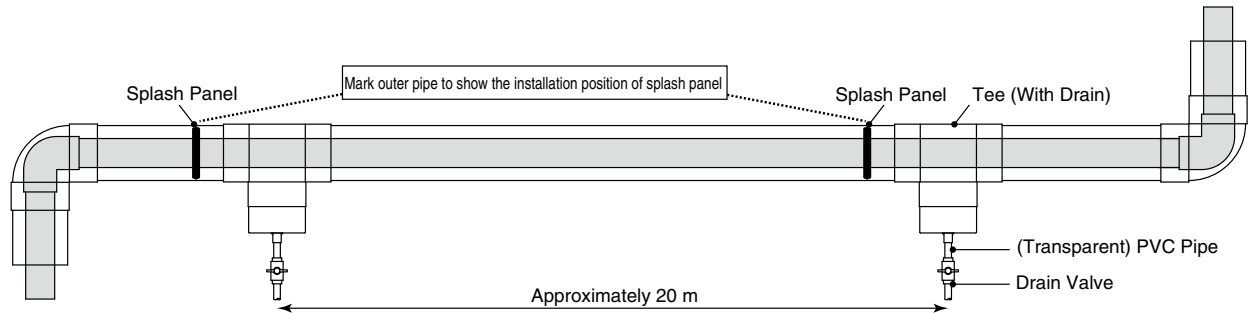

6. Outer Pipe End Treatment

Use an end cap for the end of outer pipe. There is a gap between inner pipe and end cap, and outer pipe is not sealed. When sealing outer pipe, install a splash panel or fill the gap by welding.

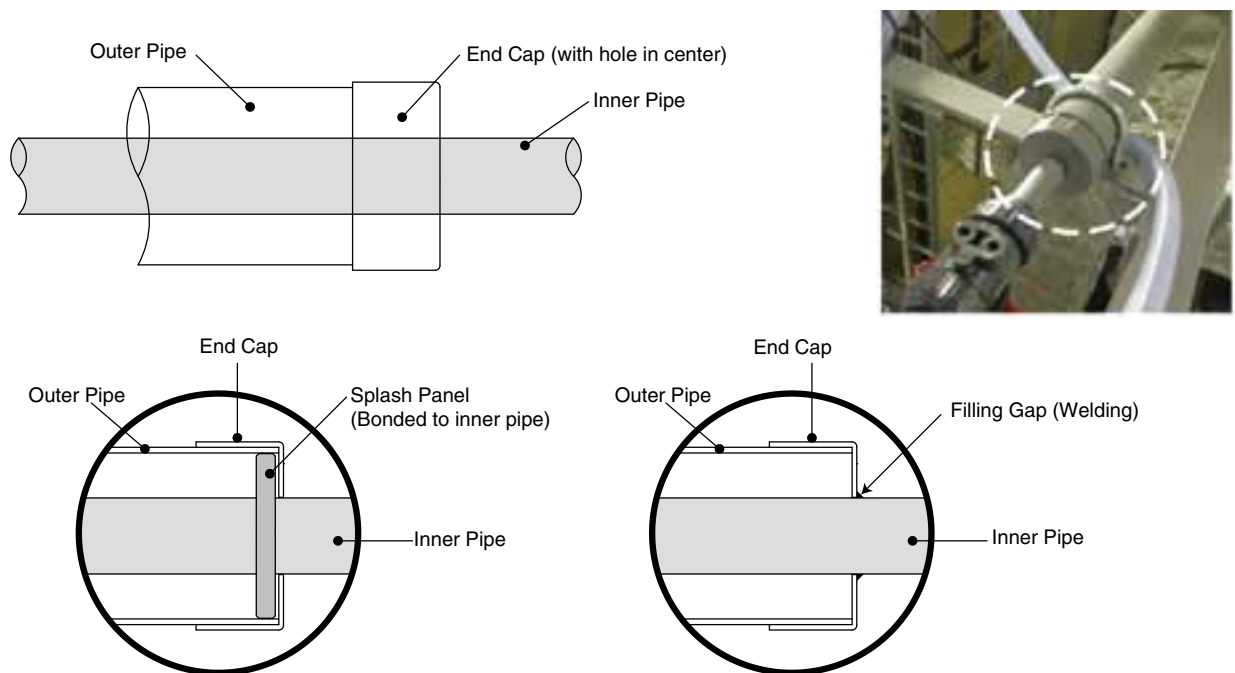

Install a splash panel before putting an end cap or fill the gap by welding after putting an end cap.

7. Various Covers (valve cover, flange cover, halved fitting)

You can install a box or cover when valves or flanges are going to be located in the middle of piping or the piping needs to be double layers after installation of inner pipe. These types of covers are also available on request.

Handling Precautions

1. Usage

- Outer pipe is for prevention of scattering to outside. Do not apply pressure to outer pipe.
- Outer pipe may change color by direct sunlight.
- Do not use them for transporting the compressed air.
- Hazardous substances regulated by the Water Pollution Act include piping invasive materials. Please check their chemical resistance in advance.

2. Installation

- Do not drop or throw during transportation and piping.
- Store them by avoiding direct sunlight and implement a measure such as placing a sheet in a way of avoiding heat accumulation.
- Do not leave fittings in an enclosed condition (inside a vehicle in Summer, in an enclosed plastic bag, etc.) under a high temperature atmosphere.
- For adhesive connection, follow the pipe fitting installation procedure to connect properly.
- Use adhesive applicable for pipe fitting to connect.
- Adhesive is applicable to the "second class organic solvents, etc." in the Ordinance on Prevention of Organic Solvent Poisoning regulated by the Ministry of Health, Labour and Welfare, and if it is going to be used over the indoor allowable usage limit, the certification of "Operation chief of organic solvents work" is required. To prevent poisoning from organic solvents or fires, be cautious of ventilation and avoid flammables.
- AV cement is applicable to "Class 1 Petroleums, Class 4 Hazardous Materials" of Article 2 of the Fire Services Act. Follow the laws and regulations and municipal ordinances for storage.
- Try to apply adhesive thinly and evenly. Applying too much could cause solvent cracking, etc. and lead to water leakage.
- During curing after connection, open both ends of pipe without enclosing and remove the solvent steam inside the pipe.
- U-bands (with rubber seat) are recommended for fixing piping. In the case of using U-bolts inevitably, provide a cushion such as rubber to prevent the pipes from touching the hardware directly.
- Use elastic slide pipes, expansion joints, elbow returns to absorb heat expansion/contraction.
- Make sure to use seal tape for thread connection part. Never use liquid seal or liquid gasket.

3. Handling in the case of liquid leakage from inner pipe

- When approaching to the pipe, wear protection glasses, gloves and clothes.
- Make the pressure inside the pipe to zero immediately.
- Do not leave the fluid accumulated in the outer pipe and discharge immediately.

PP Pipe & Fittings

Pipe & Fittings	P.142
Flange	P.153
EF Socket	P.154
Welding Rod	P.155
Prefab Joint	P.155
IAM LOCK	P.157
Technical Document	P.158



PRODUCT MODEL CODE LIST

Type	Field	Material	Standard/Wall Thickness	Standard	Type	Size	Length
P	N	*	PP	I	N	***	04
P Pipe	N Standard	P PP 4 Lubricant Free X PPLEX	PP PP Pipe	I ISO	N Standard	015 15mm I 200 200mm	04 4mPN10 04U 4mPN4

Straight Pipe

PRODUCT MODEL CODE

PP ▶ P N P PP I N Size 04
Lubricant Free ▶ P N 4 PP I N Size 04

PN10/SDR11

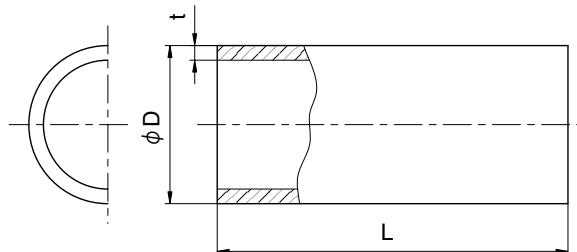

Dimensions Table

(Unit: mm)

PN10/SDR11									
Size	Product Display	D (Outer Diameter)		t (Wall Thickness)		Inner Diameter Proximity (Reference)	L (Length)		Reference Weight (kg/m)
		Basic Dimension	Average Outer Dimensional Tolerance	Basic Dimension	Tolerance		Basic Dimension	Tolerance	
15	d20	20	+0.3 0	1.9	+0.4 0	16.2	4000	±10	0.110
20	d25	25	+0.3 0	2.3	+0.5 0	20.4			0.166
25	d32	32	+0.3 0	3.0	+0.5 0	26.2			0.271
32	d40	40	+0.4 0	3.7	+0.6 0	32.6			0.421
40	d50	50	+0.5 0	4.6	+0.7 0	40.8			0.649
50	d63	63	+0.6 0	5.8	+0.8 0	51.4			1.028
65	d75	75	+0.7 0	6.9	+0.9 0	61.4			1.447
80	d90	90	+0.9 0	8.2	+1.1 0	73.6			2.083
100	d110	110	+1.0 0	10.0	+1.2 0	90.0			3.099
125	d140	140	+1.3 0	12.8	+1.5 0	114.6			5.008
150	d180	180	+1.7 0	16.4	+1.9 0	147.2	8.250		
200	d225	225	+2.1 0	20.5	+2.3 0	184.0	12.864		

PN4/SDR26

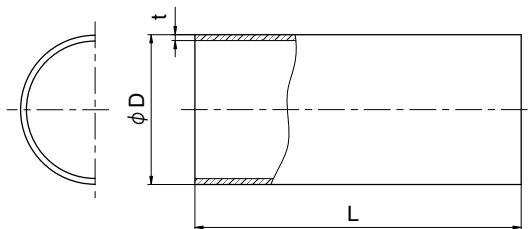

Dimensions Table

(Unit: mm)

PN4/SDR26									
Size	Product Display	D (Outer Diameter)		t (Wall Thickness)		Inner Diameter Proximity (Reference)	L (Length)		Reference Weight (kg/m)
		Basic Dimension	Average Outer Dimensional Tolerance	Basic Dimension	Tolerance		Basic Dimension	Tolerance	
125	d140	140	+1.3 0	5.4	+0.8 0	129.2	4000	±10	2.224
150	d180	180	+1.7 0	7.0	+1.0 0	166.0			3.697
200	d225	225	+2.1 0	8.7	+1.1 0	207.6			5.702

- Notes:
1. 15 to 200 mm: DIN8077
 2. SDR (Standard Dimension Ratio): Ratio of standard outer diameter and minimum wall thickness (D/t)
 3. PN10 means 20°C maximum working pressure is 1.0 MPa.
 4. PN4 means 20°C maximum working pressure is 0.4 MPa.
 5. For connection of PN4/SDR26, fittings shown in this catalog are usable.
 6. For other sizes, please consult separately.

PRODUCT MODEL CODE LIST

■ TS Fitting

Type	Field	Material	Model	Standard	Connection	Size	Usage
T	N	*	**	I	*	***	**
T TS Fitting	N Standard	P PP 4 Lubricant Free	SO Socket/Reducer 9L 90° Elbow 4L 45° Elbow TE Tee CP End Cap AO Male Adopter AM Female Adopter 9B 90° Bend AD Flange Adopter	I ISO	T Socket F Spigot	015 15mm 200 200mm 020015 20x15mm 200150 200x150mm	BF For Butterfly Valve

■ Flange

Type	Field	Model	Material	Standard	Size	Others
F	N	B	P	1	***	F
F Flange	N Standard	B Backing Flange	P PP	1 JIS 10K	015 15mm 200 200mm	F For Spigot

Socket Common Dimensions

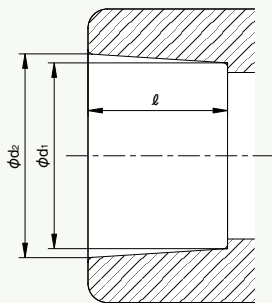

15 – 100 mm (d20 – d110)

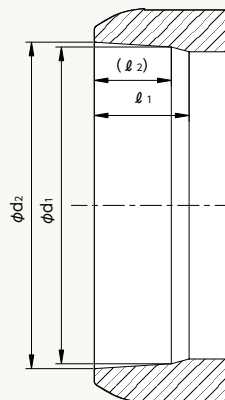

125 – 200 mm (d140 – d225)

■ Dimensions Table

(Unit: mm)

Size	Product Display	d ₁			d ₂			Socket length (Min.)	l ₁	l ₂ (Reference)
		Basic Dimension	Average Inner Dimensional Tolerance	Circularity (Max.)	Basic Dimension	Average Inner Dimensional Tolerance	Circularity (Max.)			
○ 15	d20	19.3	⁰ _{-0.3}	0.4	19.5	⁰ _{-0.3}	0.4	14.5	–	–
○ 20	d25	24.3	⁰ _{-0.4}	0.4	24.5	⁰ _{-0.3}	0.4	16	–	–
○ 25	d32	31.3	⁰ _{-0.4}	0.5	31.5	⁰ _{-0.4}	0.5	18	–	–
○ 32	d40	39.2	⁰ _{-0.4}	0.5	39.45	⁰ _{-0.4}	0.5	20.5	–	–
○ 40	d50	49.2	⁰ _{-0.5}	0.6	49.45	⁰ _{-0.5}	0.6	23.5	–	–
○ 50	d63	62.1	⁰ _{-0.5}	0.6	62.5	⁰ _{-0.6}	0.6	27.5	–	–
○ 65	d75	73.95	⁰ _{-0.5}	1	74.25	⁰ _{-0.5}	1	31	–	–
○ 80	d90	88.85	⁰ _{-0.6}	1	89.2	⁰ _{-0.6}	1	35.5	–	–
□ 100	d110	108.65	⁰ _{-0.6}	1	109.05	⁰ _{-0.6}	1	41.5	–	–
□ 125	d140	139.1	⁰ _{-2.0}	2.0	139.4	⁰ _{-2.0}	2.0	–	41.5	32.7
□ 150	d180	178.7	⁰ _{-2.0}	2.0	179.1	⁰ _{-2.0}	2.0	–	50.5	41.7
□ 200	d225	223.2	⁰ _{-2.0}	2.0	223.7	⁰ _{-2.0}	2.0	–	61.0	52.3

Notes: 1. ○ are accordance with DIN 16962 type B.

2. □ conform to the AV standard.

3. Circularity: Difference of maximum and minimum of socket inner dimensions.

Socket

PRODUCT
MODEL CODE

PP ▶ T N P SO I T Size
Lubricant Free ▶ T N 4 SO I T Size

15 – 100 mm (d20 – d110)

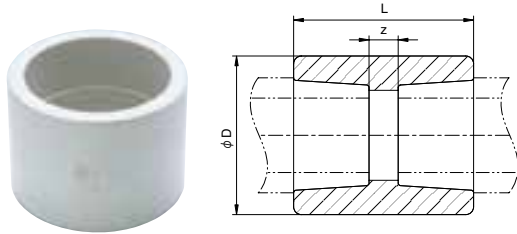

125 – 200 mm (d140 – d225)

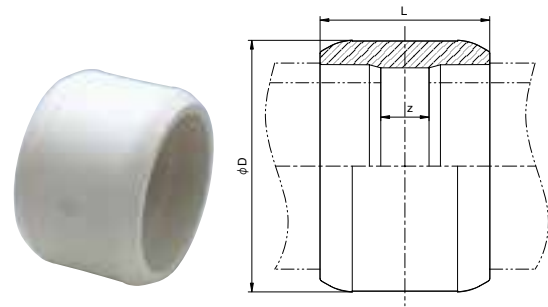

Dimensions Table

(Unit: mm)

Size	Product Display	D	L	z	Reference Weight (kg)
○ 15	d20	30.5	35	6	0.015
○ 20	d25	35.5	39	7	0.019
○ 25	d32	43.5	43	7	0.030
○ 32	d40	53.5	48	7	0.047
○ 40	d50	66	55	8	0.079
○ 50	d63	82	62	7	0.131

(Unit: mm)

Size	Product Display	D	L	z	Reference Weight (kg)
○ 65	d75	92.5	70	8	0.161
○ 80	d90	110	81	10	0.253
○ 100	d110	134	96	13	0.431
□ 125	d140	172	116	33	0.821
□ 150	d180	221	140	39	1.562
□ 200	d225	276	167	45	2.820

Notes: 1. ○ are accordance with DIN 16962-8. 2. □ conform to the AV standard.

90° Elbow

PRODUCT
MODEL CODE

PP ▶ T N P 9L I T Size
Lubricant Free ▶ T N 4 9L I T Size

15 – 100 mm (d20 – d110)

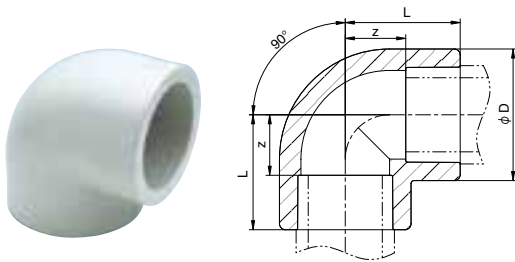

125 – 200 mm (d140 – d225)

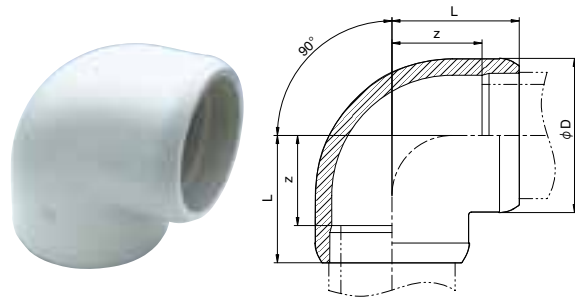

Dimensions Table

(Unit: mm)

Size	Product Display	D	L	z	Reference Weight (kg)
○ 15	d20	30.5	28	13.5	0.023
○ 20	d25	35.5	32	16	0.032
○ 25	d32	43.5	38	20	0.052
○ 32	d40	53.5	44	23.5	0.084
○ 40	d50	66	51	27.5	0.136
○ 50	d63	82	62	34.5	0.250

(Unit: mm)

Size	Product Display	D	L	z	Reference Weight (kg)
○ 65	d75	92.5	75.5	44.5	0.340
○ 80	d90	110	88	52.5	0.526
○ 100	d110	134	106	64.5	0.953
□ 125	d140	172	142	100.5	1.922
□ 150	d180	221	179	128.5	4.058
□ 200	d225	276	220	159.0	7.618

Notes: 1. ○ are accordance with DIN 16962-6. 2. □ conform to the AV standard.

45° Elbow

PRODUCT MODEL CODE
 PP ▶ T N P 4L I T Size
 Lubricant Free ▶ T N 4 4L I F Size

15 – 100 mm (d20 – d110)

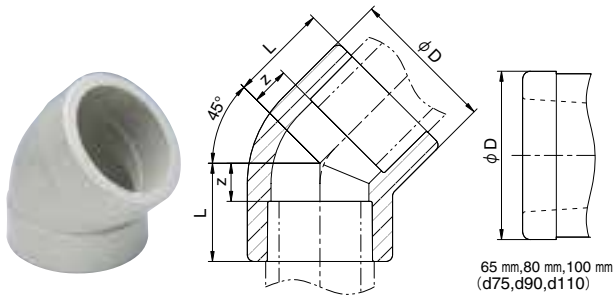

125 – 200 mm (d140 – d225)

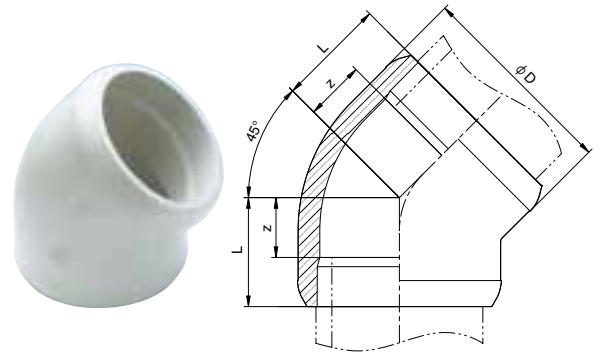

Dimensions Table

(Unit: mm)

Size	Product Display	D	L	z	Reference Weight (kg)
○ 15	d20	31	21.5	7	0.018
○ 20	d25	36	24.5	8.5	0.025
○ 25	d32	44	28	10	0.037
○ 32	d40	55	34	13.5	0.070
○ 40	d50	66	37	13.5	0.102
○ 50	d63	82	48	20.5	0.180

(Unit: mm)

Size	Product Display	D	L	z	Reference Weight (kg)
○ 65	d75	92	51.5	20.5	0.203
○ 80	d90	111	59	23.5	0.340
○ 100	d110	135.5	69	27.5	0.605
□ 125	d140	172	92	50.5	1.299
□ 150	d180	221	114	63.5	2.662
□ 200	d225	276	140	79.0	4.939

Notes: 1. ○ are accordance with DIN 16962-6. 2. □ conform to the AV standard.

Tee (Same Diameter)

PRODUCT MODEL CODE
 PP ▶ T N P TE I T Size
 Lubricant Free ▶ T N 4 TE I T Size

15 – 100 mm (d20 – d110)

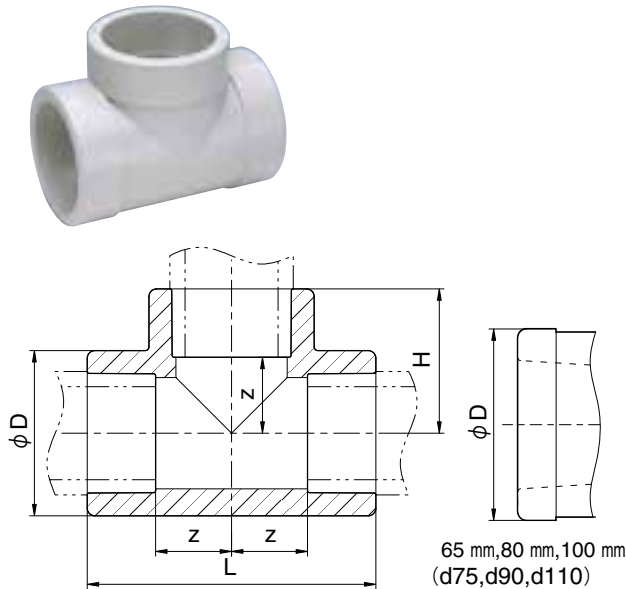

125 – 200 mm (d140 – d225)

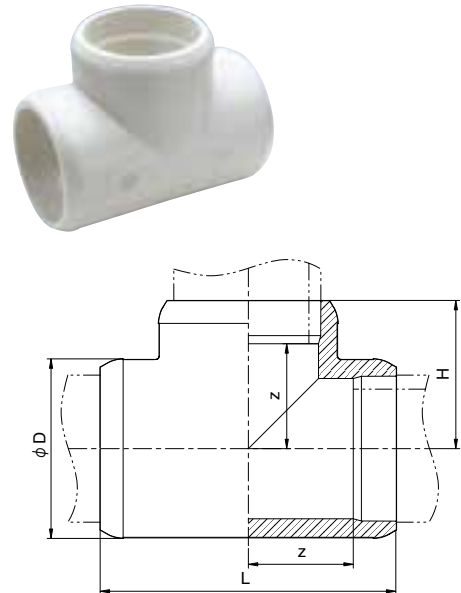

Dimensions Table

(Unit: mm)

Size	Product Display	D	L	H	z	Reference Weight (kg)
○ 15	d20	30.5	57	28.5	14	0.029
○ 20	d25	35.5	65	32.5	16.5	0.041
○ 25	d32	43.5	76	38	20	0.060
○ 32	d40	55	88	44	23.5	0.108
○ 40	d50	66	103	51.5	28	0.163
○ 50	d63	82	126	63	35.5	0.292

(Unit: mm)

Size	Product Display	D	L	H	z	Reference Weight (kg)
○ 65	d75	92.5	152	76	45	0.358
○ 80	d90	111	176	88	52.5	0.625
○ 100	d110	135	213	106.5	65	1.030
□ 125	d140	172	284	142	100.5	1.317
□ 150	d180	221	358	179	128.5	4.902
□ 200	d225	276	440	220	159.0	9.300

Notes: 1. ○ are accordance with DIN 16962-7. 2. □ conform to the AV standard.

Reducer (Bush-Type)

PRODUCT MODEL CODE
 PP ▶ T N P SO I T Size
 Lubricant Free ▶ T N 4 SO I T Size

20x15 mm – 100x80 mm
 (d25xd20 – d110xd90)

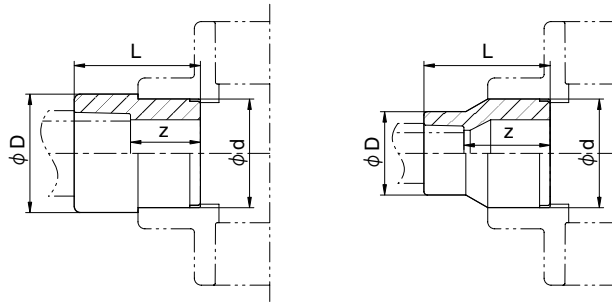

Notes: The marked (*) products in the Dimensions Table have the shape shown in the figure above.

125x100 mm – 200x150 mm
 (d140xd110 – d225xd180)

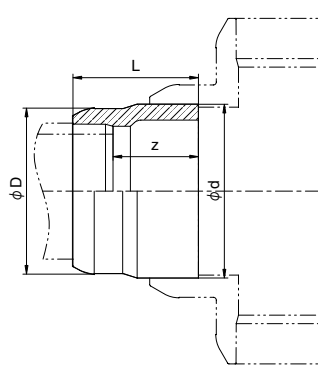

Dimensions Table

(Unit: mm)

Size	Product Display	D	d	L	Z	Reference Weight (kg)
※ ○ 20x 15	d25xd20	30	25	35	20.5	0.011
○ 25x 15	d32xd20	30	32	43	28.5	0.016
※ ○ 25x 20	d32xd25	35	32	38	22	0.016
○ 32x 15	d40xd20	30	40	50	35.5	0.022
○ 32x 20	d40xd25	35	40	50	34	0.024
※ ○ 32x 25	d40xd32	43	40	48	30	0.029
○ 40x 15	d50xd20	31	50	54	39.5	0.034
○ 40x 20	d50xd25	36	50	54	38	0.035
○ 40x 25	d50xd32	43	50	54	36	0.035
※ ○ 40x 32	d50xd40	54	50	54	33.5	0.050
○ 50x 20	d63xd25	37	63	65	49	0.058
○ 50x 25	d63xd32	43	63	65	47	0.056
○ 50x 32	d63xd40	54	63	64	43.5	0.068
※ ○ 50x 40	d63xd50	66	63	64	40.5	0.085
※ ○ 65x 50	d75xd63	81	75	61	33.5	0.105
○ 80x 50	d90xd63	81	90	89	61.5	0.171
※ ○ 80x 65	d90xd75	92.5	90	70	39	0.148
※ ○ 100x 80	d110xd90	112	110	81	45.5	0.267
□ 125x100	d140xd110	135.5	140	110	68.5	0.502
□ 150x125	d180xd140	172	180	130	88.5	0.971
□ 200x150	d225xd180	221	225	160	109.5	1.868

- Notes: 1. ○ are accordance with DIN 16962-9.
 2. □ conform to the AV standard.
 3. Socket is required for connection with pipe.

End Cap

PRODUCT MODEL CODE	PP	T	N	P	CP	I	T	Size
	Lubricant Free	T	N	4	CP	I	T	Size

15 – 100 mm (d20 – d110)

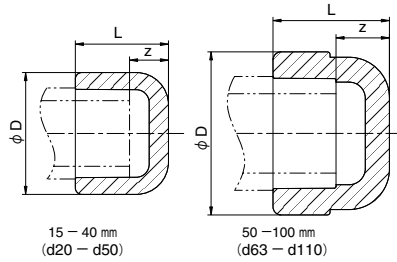

Dimensions Table

(Unit: mm)

Size	Product Display	D	L	z	Reference Weight (kg)
○ 15	d20	30	27	12.5	0.013
○ 20	d25	36	30	14	0.019
○ 25	d32	44	32	14	0.028
○ 32	d40	55	36	15.5	0.039
○ 40	d50	66	43	19.5	0.076
○ 50	d63	80	47	19.5	0.129
○ 65	d75	92	63	32	0.165
○ 80	d90	111	74	38.5	0.296
○ 100	d110	133.5	91	49.5	0.430

Notes: ○ are accordance with DIN 16962-8.

Male Threaded Adopter (Spigot)

PRODUCT MODEL CODE	PP	T	N	P	AO	I	F	Size
	Lubricant Free	T	N	4	AO	I	F	Size

15 – 50 mm (d20 – d63)

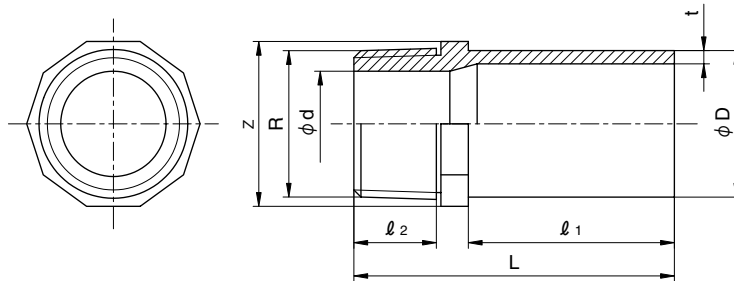

Dimensions Table

(Unit: mm)

Size	Product Display	D	t	d	R	L	l ₁	l ₂	Z	Reference Weight (kg)
15	d20	20	1.9	13	R1/2	60	37	15	24	0.009
20	d25	25	2.3	18	R3/4	62	40	15	27	0.012
25	d32	32	3.0	23	R1	70	44	19	36	0.021
32	d40	40	3.7	29	R1 1/4	76	49	20	46	0.037
40	d50	50	4.6	34	R1 1/2	84	55	21	55	0.057
50	d63	63	5.8	45	R2	93	63	22	65	0.095

Notes: 1. R: Tapered male thread for pipes. 2. Socket is required for connecting pipe. 3. Do not use them for connecting with steel pipe.

Female Threaded Adopter (Spigot)

PRODUCT MODEL CODE	PP	T	N	P	AM	I	F	Size
	Lubricant Free	T	N	4	AM	I	F	Size

15 – 50 mm (d20 – d63)

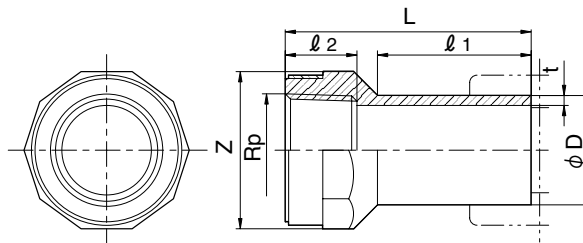

Dimensions Table

(Unit: mm)

Size	Product Display	D	t	Rp	L	l ₁	l ₂	Z	Reference Weight (kg)
15	d20	20	1.9	Rp1/2	58	37	16	30	0.016
20	d25	25	2.3	Rp3/4	63	40	18	36	0.022
25	d32	32	3.0	Rp1	71	44	21	46	0.039
32	d40	40	3.7	Rp1 1/4	79	49	23	55	0.056
40	d50	50	4.6	Rp1 1/2	84	55	24	60	0.078
50	d63	63	5.8	Rp2	97	63	29	75	0.138

Notes: 1. Rp: Parallel female thread for pipes. 2. Socket is required for connecting pipe. 3. Do not use them for connecting with steel pipe.

90° Bend (Spigot)

PRODUCT
MODEL CODE

PP ▶ T N P 9B I F Size
Lubricant Free ▶ T N 4 9B I F Size

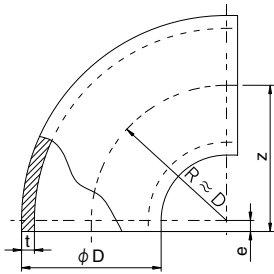

Dimensions Table

(Unit: mm)

Size	Product Display	D	t	e	z	Weight (kg)
15	d20	20	1.9	2	21	0.005
20	d25	25	2.3	3	26	0.007
25	d32	32	3.0	4	34	0.017
32	d40	40	3.7	5	43	0.034
40	d50	50	4.6	5	53	0.056
50	d63	63	5.8	5	66	0.115

(Unit: mm)

Size	Product Display	D	t	e	z	Weight (kg)
65	d75	75	6.9	6	78	0.190
80	d90	90	8.2	6	93	0.325
100	d110	110	10.0	8	115	0.570
125	d140	140	12.8	8	145	1.140
150	d160	160	14.6	8	165	1.770
200	d225	225	20.5	10	231	4.690

45° Elbow (Spigot)

PRODUCT
MODEL CODE

PP ▶ T N P 4L I F Size
Lubricant Free ▶ T N 4 4L I F Size

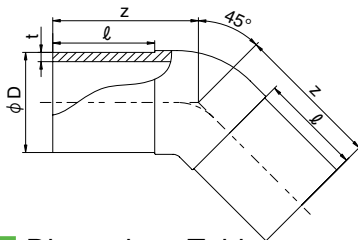

Dimensions Table

(Unit: mm)

Size	Product Display	D	t	l	z	Weight (kg)
15	d20	20	1.9	52	70	0.019
20	d25	25	2.3	57	75	0.029
25	d32	32	3.0	70	90	0.056
32	d40	40	3.7	73	96	0.087
40	d50	50	4.6	60	80	0.108
50	d63	63	5.8	65	90	0.202

(Unit: mm)

Size	Product Display	D	t	l	z	Weight (kg)
65	d75	75	6.9	70	93	0.277
80	d90	90	8.2	80	110	0.452
100	d110	110	10.0	90	125	0.770
125	d140	140	12.8	120	167	1.680
150	d160	160	14.6	140	190	2.550
200	d225	225	20.5	152	218	5.692

Same Diameter Tee (Spigot)

PRODUCT
MODEL CODE

PP ▶ T N P TE I F Size
Lubricant Free ▶ T N 4 TE I F Size

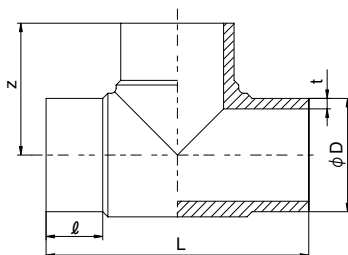

Dimensions Table

(Unit: mm)

Size	Product Display	D	t	l	L	z	Weight (kg)
15	d20	20	1.9	10	78	39	0.021
20	d25	25	2.3	10	84	42	0.030
25	d32	32	3.0	10	88	44	0.043
32	d40	40	3.7	10	92	46	0.065
40	d50	50	4.6	12	100	50	0.110
50	d63	63	5.8	15	128	64	0.229

(Unit: mm)

Size	Product Display	D	t	l	L	z	Weight (kg)
65	d75	75	6.9	15	152	76	0.370
80	d90	90	8.2	40	200	100	0.689
100	d110	110	10.0	55	256	128	1.278
125	d140	140	12.8	62	314	157	2.480
150	d160	160	14.6	58	320	160	3.240
200	d225	225	20.5	75	450	225	9.129

Reducing Tee (Spigot)

PRODUCT MODEL CODE: PP T N P TE I F Size
 Lubricant Free: T N 4 TE I F Size

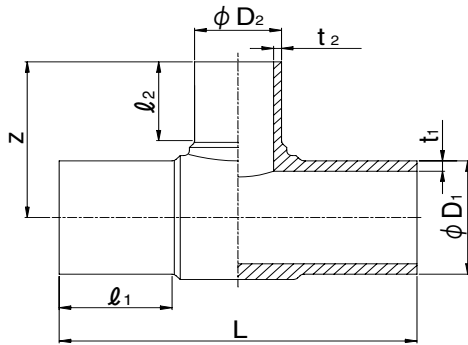

Dimensions Table

(Unit: mm)

Size	Product Display	D ₁	t ₁	l ₁	D ₂	t ₂	l ₂	L	z	Weight (kg)
50x40	d63xd50	63	5.8	63	50	4.6	56	220	103	0.297
65x25	d75xd32	75	6.9	70	32	3.0	46	256	108	0.489
65x40	d75xd50	75	6.9	70	50	4.6	56	255	113	0.507
65x50	d75xd63	75	6.9	70	63	5.8	63	258	117	0.543
80x40	d90xd50	90	8.2	80	50	4.6	58	285	118	0.785
80x50	d90xd63	90	8.2	79	63	5.8	65	285	124	0.818
80x65	d90xd75	90	8.2	75	75	6.9	68	275	138	0.766
100x50	d110xd63	110	10.0	88	63	5.8	68	325	148	1.373
100x65	d110xd75	110	10.0	84	75	6.9	70	310	151	1.185

(Unit: mm)

Size	Product Display	D ₁	t ₁	l ₁	D ₂	t ₂	l ₂	L	z	Weight (kg)
100x80	d110xd90	110	10.0	88	90	8.2	80	323	160	1.478
150x50	d160xd63	160	14.6	100	63	5.8	65	345	176	2.593
150x65	d160xd75	160	14.6	100	75	6.9	74	345	180	2.630
150x80	d160xd90	160	14.6	105	90	8.2	80	415	190	3.603
150x100	d160xd110	160	14.6	105	110	10.0	88	415	198	3.747
200x65	d225xd75	225	20.5	120	75	6.9	75	445	227	6.578
200x80	d225xd90	225	20.5	130	90	8.2	80	560	227	9.417
200x100	d225xd110	225	20.5	130	110	10.0	85	560	236	9.402
200x150	d225xd160	225	20.5	130	160	14.6	105	560	255	9.919

Reducer (Spigot)

PRODUCT MODEL CODE: PP T N P SO I F Size
 Lubricant Free: T N 4 SO I F Size

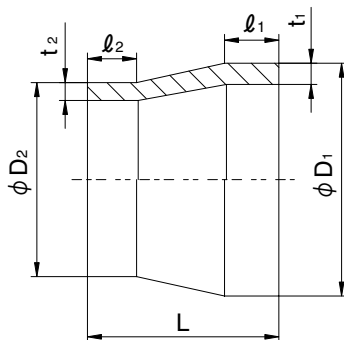

Dimensions Table

(Unit: mm)

Size	Product Display	D ₁	t ₁	l ₁	D ₂	t ₂	l ₂	L	Weight (kg)
20x15	d25xd20	25	2.3	9	20	1.9	6	24	0.003
25x15	d32xd20	32	3.0	18	20	1.9	12	41	0.009
25x20	d32xd25	32	3.0	18	25	2.3	13	44	0.010
32x15	d40xd20	40	3.7	20	20	1.9	20	50	0.014
32x20	d40xd25	40	3.7	15	25	2.3	17	45	0.015
32x25	d40xd32	40	3.7	15	32	3.0	14	45	0.015
40x20	d50xd25	50	4.6	27	25	2.3	25	85	0.037
40x25	d50xd32	50	4.6	27	32	3.0	26	85	0.041
40x32	d50xd40	50	4.6	28	40	3.7	26	82	0.045
50x25	d63xd32	63	5.8	27	32	3.0	26	90	0.062
50x32	d63xd40	63	5.8	27	40	3.7	26	90	0.067
50x40	d63xd50	63	5.8	28	50	4.6	28	90	0.076
65x25	d75xd32	75	6.9	17	32	3.0	11	60	0.058
65x32	d75xd40	75	6.9	30	40	3.7	25	70	0.070
65x40	d75xd50	75	6.9	30	50	4.6	25	70	0.076
65x50	d75xd63	75	6.9	30	63	5.8	30	70	0.083

(Unit: mm)

Size	Product Display	D ₁	t ₁	l ₁	D ₂	t ₂	l ₂	L	Weight (kg)
80x 40	d90x d50	90	8.2	30	50	4.6	28	97	0.142
80x 50	d90x d63	90	8.2	30	63	5.8	25	93	0.151
80x 65	d90x d75	90	8.2	30	75	6.9	28	90	0.163
100x 40	d110x d50	110	10.0	28	50	4.6	15	90	0.194
100x 50	d110x d63	110	10.0	42	63	5.8	35	110	0.252
100x 65	d110x d75	110	10.0	40	75	6.9	33	95	0.243
100x 80	d110x d90	110	10.0	42	90	8.2	40	105	0.280
125x 65	d140x d75	140	12.8	50	75	6.9	37	110	0.426
125x 80	d140x d90	140	12.8	50	90	8.2	38	110	0.436
125x100	d140xd110	140	12.8	50	110	10.0	45	110	0.469
150x 80	d160xd 90	160	14.6	55	90	8.2	42	140	0.705
150x100	d160xd110	160	14.6	55	110	10.0	42	130	0.712
150x125	d160xd140	160	14.6	50	140	12.8	45	122	0.744
200x125	d225xd140	225	20.5	62	140	12.8	45	155	1.553
200x150	d225xd160	225	20.5	62	160	14.6	52	160	1.645

Flange Adopter (Spigot)

PRODUCT MODEL CODE

PP	T	N	P	AD	I	F	Size
Lubricant Free	T	N	4	AD	I	F	Size
For Butterfly Valve	T	N	P	AD	I	F	Size BF
For Butterfly Valve (Lubricant Free)	T	N	4	AD	I	F	Size BF

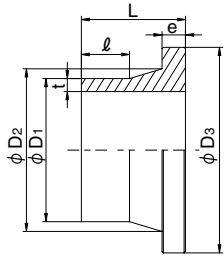

■ Dimensions Table

(Unit: mm)

Size	Product Display	D ₁	D ₂	D ₃	t	e	ℓ	L	Weight (kg)
15	d20	20	27	45	1.9	7	30	50	0.016
20	d25	25	33	56	2.3	9	28	50	0.027
25	d32	32	40	62	3.0	10	27	50	0.038
32	d40	40	50	74	3.7	11	25	52	0.065
40	d50	50	61	78	4.6	12	25	52	0.068
50	d63	63	75	93	5.8	14	22	55	0.110
65	d75	75	89	111	6.9	16	20	55	0.169
80	d90	90	105	120	8.2	18	45	82	0.259
100	d110	110	125	152	10.0	18	40	82	0.410
125	d140	140	155	182	12.8	25	30	82	0.675
150	d160	160	175	212	14.6	25	30	80	0.876
200	d225	225	235	262	20.5	32	45	120	1.977

For Butterfly Valve

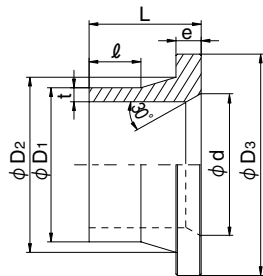

■ Dimensions Table

(Unit: mm)

Size	Product Display	D ₁	D ₂	D ₃	d	t	e	ℓ	L	Weight (kg)
100	d110	110	125	152	100	10.0	18	40	82	0.400
125	d140	140	155	182	125	12.8	25	30	82	0.665
150	d160	160	175	212	150	14.6	25	30	80	0.864
200	d225	225	235	262	200	20.5	32	45	120	1.962

Backing Flange (For Spigot)

PRODUCT MODEL CODE

F	N	B	P	1	Size	F
---	---	---	---	---	------	---

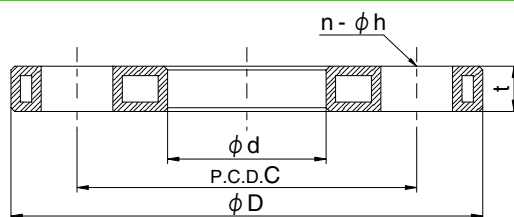

■ Dimensions Table

(Unit: mm)

Size	Product Display	d	JIS 10K				t	Weight (kg)
			D	C	n	h		
15	d20	28	95	70	4	15	12	0.243
20	d25	34	100	75	4	15	12	0.305
25	d32	42	125	90	4	19	16	0.470
32	d40	51	135	100	4	19	18	0.708
40	d50	62	140	105	4	19	18	0.785
50	d63	78	155	120	4	19	18	0.895
65	d75	92	175	140	4	19	18	1.165
80*	d90	108	185	150	8	19	20	1.360
100*	d110	128	210	175	8	19	20	1.695
125	d140	158	250	210	8	23	24	2.335
150*	d160	178	280	240	8	23	24	3.550
200	d225	240	330	290	12	23	24	4.230

* Material: STEEL+PPG Covering

End Cap (Spigot)

PRODUCT
MODEL CODE

T N P CP I F Size

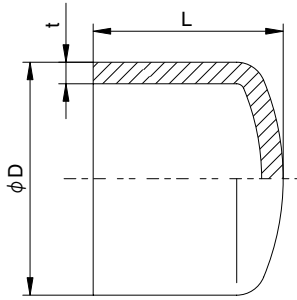

Dimensions Table

(Unit: mm)

Size	Product Display	D	t	L	Weight (kg)
15	d20	20	1.9	49	0.005
20	d25	25	2.3	50	0.008
25	d32	32	3.0	55	0.016
32	d40	40	3.7	62	0.026
40	d50	50	4.6	72	0.046
50	d63	63	5.8	85	0.090

(Unit: mm)

Size	Product Display	D	t	L	Weight (kg)
65	d75	75	6.9	95	0.136
80	d90	90	8.2	110	0.224
100	d110	110	10.0	124	0.371
125	d140	140	12.8	140	0.702
150	d160	160	14.6	160	1.063
200	d225	225	20.5	206	2.619

Male Threaded Adopter (Spigot)

PRODUCT
MODEL CODE

PP ▶ T N P AO I F Size

Lubricant Free ▶ T N 4 AO I F Size

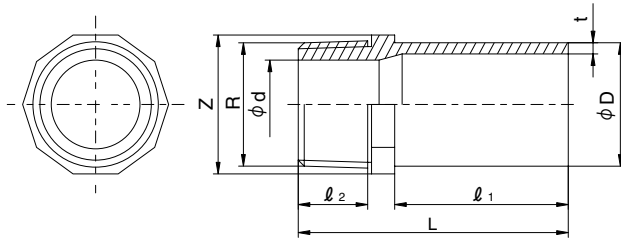

Dimensions Table

(Unit: mm)

Size	Product Display	D	t	d	R	L	l ₁	l ₂	z	Weight (kg)
15	d20	20	1.9	13	1/2 inch	60	37	15	24	0.009
20	d25	25	2.3	18	3/4 inch	62	40	15	27	0.012
25	d32	32	3.0	23	1 inch	70	44	19	36	0.021
32	d40	40	3.7	29	1 1/4 inch	76	49	20	46	0.037
40	d50	50	4.6	34	1 1/2 inch	84	55	21	55	0.057
50	d63	63	5.8	45	2 inch	93	63	22	65	0.095

Notes: "R" means taper pipe thread. Do not use them for connecting with steel pipe.

Female Threaded Adopter (Spigot)

PRODUCT
MODEL CODE

PP ▶ T N P AM I F Size

Lubricant Free ▶ T N 4 AM I F Size

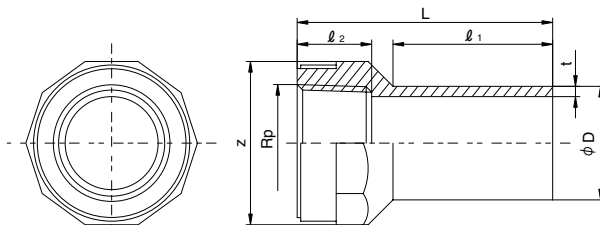

Dimensions Table

(Unit: mm)

Size	Product Display	D	t	Rp	L	l ₁	l ₂	z	Weight (kg)
15	d20	20	1.9	1/2 inch	58	37	16	30	0.016
20	d25	25	2.3	3/4 inch	63	40	18	36	0.022
25	d32	32	3.0	1 inch	71	44	21	46	0.039
32	d40	40	3.7	1 1/4 inch	79	49	23	55	0.056
40	d50	50	4.6	1 1/2 inch	84	55	24	60	0.078
50	d63	63	5.8	2 inch	97	63	29	75	0.138

Notes: "Rp" means parallel pipe thread. Do not use them for connecting with steel pipe.

Flange Adopter (Socket)

PRODUCT MODEL CODE	PP	T	N	P	AD	I	T	Size
	Lubricant Free	T	N	4	AD	I	T	Size

15 – 100 mm (d20 – d110)

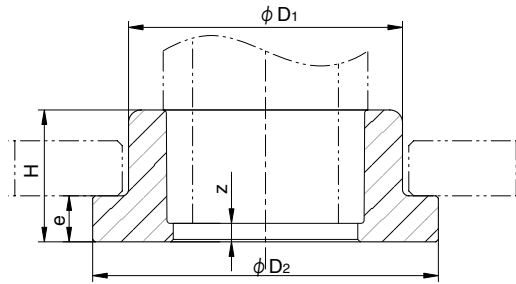

Dimensions Table

(Unit: mm)

Size	Product Display	D ₁	D ₂	e	H	z	Reference Weight (kg)
15	d20	27.5	45	10	21.5	7	0.015
20	d25	33.5	56	10	22	6	0.023
25	d32	41.5	62	10	24.5	6.5	0.029
32	d40	50	74	11	28.5	8	0.044
40	d50	61	78	12	32	8.5	0.052
50	d63	76	93	14	36	8.5	0.081
65	d75	90	106	10.5	35	4	0.091
80	d90	109	125	11	43	7.5	0.156
100	d110	131	150	12.5	51	9.5	0.254

Notes: 1. DIN16962-12 2. Connection requires backing flange.

Flange Adopter

PRODUCT MODEL CODE	PP	T	N	P	AD	I	T	Size
	Lubricant Free	T	N	4	AD	I	T	Size
	For Butterfly Valve	T	N	P	AD	I	T	Size BF
	For Butterfly Valve (Lubricant Free)	T	N	4	AD	I	T	Size BF

125 – 200 mm (d140 – d225)

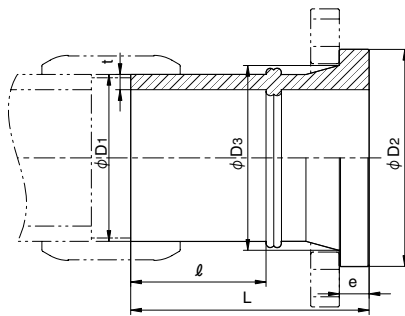

For Butterfly Valve

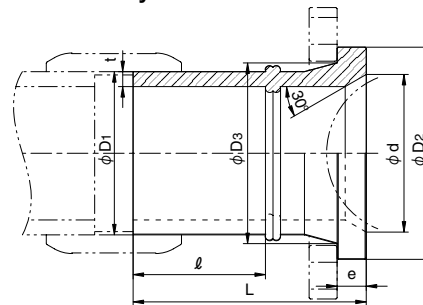

Dimensions Table

(Unit: mm)

Size	Product Display	D ₁	t	D ₂	D ₃ (Reference)	e	ℓ	L ^{±2}	d	Reference Weight (kg)
125	d140	140	12.8	182	155	25	105 (Min.)	195	125	5.7
150	d180	180	16.4	211	180	30	265 (Reference)	350	–	6.9
200	d225	225	20.5	262	235	32	250 (Reference)	370	200	11.3

Notes: 1. D₁ and t are accordance with DIN (PN10/SDR11). 2. Connecting with pipe requires socket and backing flange.

PRODUCT MODEL CODE LIST

Type	Field	Model	Material	Standard	Size	Others
F	N	*	P	1	***	K
⋮	⋮	⋮	⋮	⋮	⋮	⋮
F Flange	N Standard	T TS Flange B Backing Flange	P PP	1 JIS 10K	015 15mm 100 100mm	K For Socket

Socket Flange

PRODUCT MODEL CODE LIST
F N T P 1 Size

15 – 100 mm (d20 – d110)

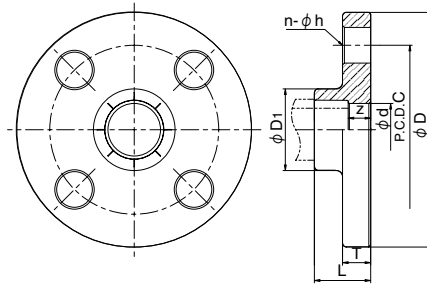

Dimensions Table

(Unit: mm)

Size	Product Display	D ₁	d	Z	T	L	JIS 10K				Reference Weight (kg)
							D	C	n	h	
15	d20	30.5	16	15.5	14	30	95	70	4	15	0.090
20	d25	35.5	21	15.0	15	31	100	75	4	15	0.105
25	d32	43.5	28	13.0	15	31	125	90	4	19	0.161
32	d40	53.5	36	12.5	16	33	135	100	4	19	0.198
40	d50	66.0	45	10.5	16	34	140	105	4	19	0.215
50	d63	82.0	57	9.5	20	37	155	120	4	19	0.317
65	d75	92.5	69	23.0	22	54	175	140	4	19	0.452
80	d90	110.0	84	18.5	22	54	185	150	8	19	0.473
100	d110	134.5	102	12.5	22	54	210	175	8	19	0.613

Notes: Flange standard is only JIS 10K.

Backing Flange (For Socket)

PRODUCT MODEL CODE LIST
F N B P 1 Size K

15 – 200 mm (d20 – d225)

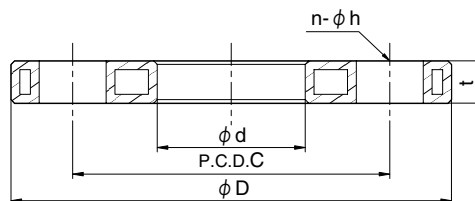

Dimensions Table

(Unit: mm)

Size	Product Display	d	JIS 10K				t	Reference Weight (kg)
			D	C	n	h		
15	d20	28	95	70	4	15	12	0.243
20	d25	34	100	75	4	15	12	0.305
25	d32	42	125	90	4	19	16	0.470
32	d40	51	135	100	4	19	18	0.708
40	d50	62	140	105	4	19	18	0.785
50	d63	78	155	120	4	19	18	0.895
65	d75	92	175	140	4	19	18	1.165
80*	d90	110	185	150	8	19	20	1.360
100*	d110	133	210	175	8	19	20	1.695
125	d140	158	250	210	8	23	24	2.335
150*	d180	183	280	240	8	23	24	3.220
200	d225	240	330	290	12	23	24	4.230

Notes: 1. * Material: STEEL+PPG Covering
2. DIN and ANSI standard products are also available.

PRODUCT MODEL CODE LIST

Type	Field	Model	Material	Standard	Size	Others
F	N	*	*	1	***	WG
F Flange	N Standard	J J Flange P P Flange Q Q Flange	P PP 4 Lubricant Free	1 JIS 10K	015 15mm I 300 300mm	WG Warm Gray

Weld/Blind Flange

PRODUCT MODEL CODE	PP	▶	F	N	J	P	1	Size	WG	Lubricant Free ▶	F	N	J	4	1	Size	WG	
	PP	▶	F	N	P	P	1	Size	WG		Lubricant Free ▶	F	N	P	4	1	Size	WG
	PP	▶	F	N	Q	P	1	Size	WG		Lubricant Free ▶	F	N	Q	4	1	Size	WG

Weld Flange

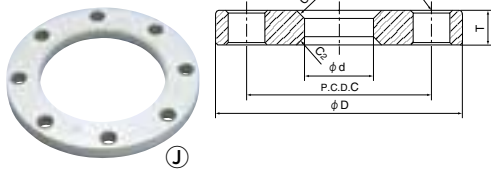

Blind Flange

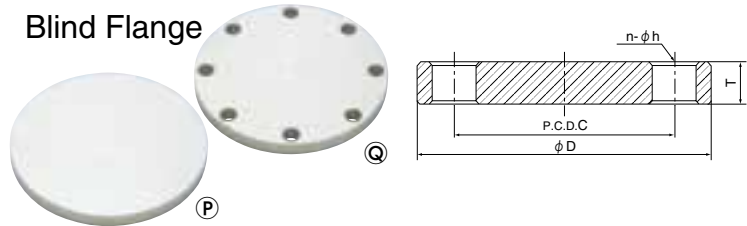

Dimensions Table

(Unit: mm)

Size	Product Display	d	JIS 10K							C ₁	C ₂	T
			C	D	n	h	C ₁	C ₂	T			
15	d20	20	70	95	4	15	3	3	12			
20	d25	25	75	100	4	15	3	3	14			
25	d32	32	90	125	4	19	3	3	14			
32	d40	40	100	135	4	19	3	3	16			
40	d50	50	105	140	4	19	3	3	16			
50	d63	63	120	155	4	19	3	4	16			
65	d75	75	140	175	4	19	3	4	18			
80	d90	90	150	185	8	19	3	4	18			
100	d110	110	175	210	8	19	3	4	18			
125	d140	140	210	250	8	23	4	4	20			
150	d180	180	240	280	8	23	4	4	22			
200	d225	225	290	330	12	23	4	4	22			
250	d250	250	355	400	12	25	4	4	24			
300	d315	315	400	445	16	25	4	4	24			

Notes: 1. d dimension is accordance with DIN8077 PP Pipe Outer Diameter.

PRODUCT MODEL CODE LIST

Type	Material	Model	Standard	Size
TN	*	EF	IS	***
TN EF Socket	P PP 4 Lubricant Free	EF EF Socket	IS ISO	015 15mm I 200 200mm

EF Socket

PRODUCT MODEL CODE	PP	▶	TN	P	EF	IS	Size
	Lubricant Free ▶	TN	4	EF	IS	Size	

15 – 200 mm (d20 – d225)

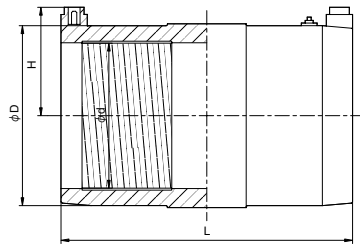

Dimensions Table

(Unit: mm)

(Unit: mm)

Size	Product Display	d	D	H	L	Reference Weight (kg)
15	d20	20	30	36	70	0.042
20	d25	25	36	39	78	0.051
25	d32	32	44	41	80	0.071
32	d40	40	53	46	92	0.098
40	d50	50	64	51	104	0.137
50	d63	63	80	58	118	0.224
65	d75	75	96	64	132	0.342
80	d90	90	120	75	146	0.491
100	d110	110	137	82	162	0.801
125	d140	140	171	100	184	1.344
150	d180	180	220	123	212	2.481
200	d225	225	273	149	212	3.870

PRODUCT MODEL CODE LIST

Type	Material			
S	P	*	*	*
...
S Welding Rod	P PP	3 3/M	1 Single 1KG	0 Wrap
		4 4/M	2 Double 1KG	1 1M
		5 5/M		

Welding Rod



Shape	Diameter	Package Unit
Welding Rod Single	3	2 kg (1 m stick)
		4 kg (roll)
	4	2 kg (1 m stick)
		4 kg (roll)
	5	2 kg (1 m stick)
		4 kg (roll)
Double	3	2 kg (1 m stick)

PRODUCT MODEL CODE	S	P	3	1	0	PRODUCT MODEL CODE	S	P	4	1	0
	S	P	3	1	1		S	P	4	1	1
	S	P	3	2	0		S	P	5	1	0
	S	P	3	2	1		S	P	5	1	1

PRODUCT MODEL CODE LIST

Type	Material	Rubber	Connection	Standard	Size	Others
JPF	P	*	T	D	***	C
...
JPF Prefab Joint	P PP	E EPDM V FKM	T Socket	D DIN	016 16mm I 050 50mm	C 21 Type

Prefab Joint (21-Type) DIN Socket

16 – 50 mm (d20 – d63)

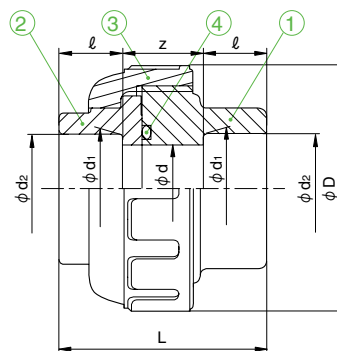

Parts Table

No.	Description	Pcs.	Material
①	Body	1	PP
②	End Connector	1	PP
③	Union Nut	1	PP
④	O-Ring	1	EPDM, FKM

Dimensions Table

Size	Product Display	d	d ₁	d ₂	l	D	L	z	Reference Weight (kg)
16 (15)	d20	15	19.3	19.5	14.5	46	40	11	0.030
20	d25	20	24.3	24.5	16	57	52	20	0.056
25	d32	25	31.3	31.5	18	67	58	22	0.089
30 (32)	d40	31	39.2	39.45	20.5	79	65	24	0.133
40	d50	40	49.2	49.45	23.5	95	74	27	0.216
50	d63	51	62.1	62.5	27.5	104	90.5	35.5	0.262

Notes: 1. d₁, d₂ and l dimensions are accordance with DIN 16962.
2. Assembled appearance/shape differs slightly by size.

PRODUCT MODEL CODE LIST

Type	Material	Rubber	Connection	Standard	Size	Type
JPF	*	*	*	*	***	*
JPF Prefab Joint	P PP U PP *U-PVC C PP *C-PVC 4 Lubricant Free	E EPDM V FKM	T Socket F Spigot	D DIN I ISO	016 16mm I 050 50mm	D PP Socket E PP Spigot

Prefab Joint (Spigot)

PRODUCT MODEL CODE	PP EPDM	JPF	P	E	F	I	Size
	PP FKM	JPF	P	V	J	I	Size
	PP EPDM Lubricant Free	JPF	4	E	F	I	Size
	PP FKM Lubricant Free	JPF	4	V	F	I	Size

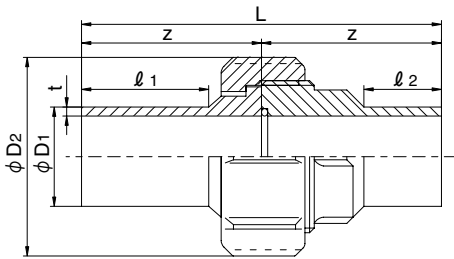

Dimensions Table

(Unit: mm)

Size	Product Display	D ₁	D ₂	t	l ₁	l ₂	Z	L	Weight (kg)
15	d20	20	47	1.9	38	26	53	106	0.053
20	d25	25	57	2.3	39	25	55	110	0.082
25	d32	32	64	3.0	42	25	59	118	0.112
32	d40	40	78	3.7	42	25	62	124	0.187
40	d50	50	89	4.6	45	25	65	130	0.259
50	d63	63	109	5.8	45	25	68	136	0.427

Notes: Material of O-ring is normally EPDM but also available with FKM.

Prefab Joint

DIN Socket

PP



JIS Socket

U-PVC C-PVC

DIN Spigot

PP



JIS Socket

U-PVC C-PVC

Features

Use them for connecting PVC pipe (U-PVC, C-PVC) and PP pipe.

Maximum Working Pressure by Temperature

① Material of body and cap nut: For U-PVC (Unit: MPa)

Size	Working Temperature (Max.: 50°C)			
	0°C	20°C	40°C	50°C
16(d20)	1.0	1.0	0.8	0.7
20(d25)	1.0	1.0	0.8	0.7
25(d32)	1.0	1.0	0.8	0.7
30(d40)	1.0	1.0	0.8	0.7
40(d50)	1.0	1.0	0.8	0.7
50(d63)	1.0	1.0	0.8	0.7

① Material of body and cap nut: For C-PVC (Unit: MPa)

Size	Working Temperature (Max.: 90°C)					
	0°C	20°C	40°C	60°C	80°C	90°C
16(d20)	1.0	1.0	0.8	0.6	0.3	0.2
20(d25)	1.0	1.0	0.8	0.6	0.3	0.2
25(d32)	1.0	1.0	0.8	0.6	0.3	0.2
30(d40)	1.0	1.0	0.8	0.6	0.3	0.2
40(d50)	1.0	1.0	0.8	0.6	0.3	0.2
50(d63)	1.0	1.0	0.8	0.6	0.3	0.2

DIN Socket-JIS Socket (PP)

DIN Spigot-JIS Socket (PP)

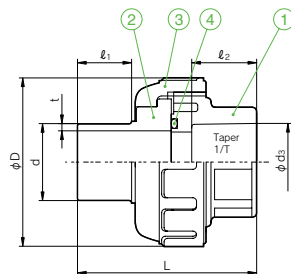
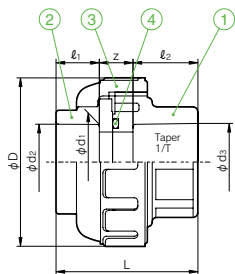

<Use Precautions>

1. Values in the table are water maximum working pressure and are not applicable for chemical solutions other than water.
2. Values in the table are calculated based on the service life of 10 years and the safety factor of 2.
3. Maximum working pressure is the pressure including the water hammer pressure. Do not use them exceeding the maximum working pressure.

Parts Table

No.	Description	Pcs.	Material
①	Body	1	U-PVC, C-PVC
②	End Connector	1	PP
③	Union Nut	1	U-PVC, C-PVC
④	O-Ring	1	EPDM, FKM

Dimensions Table

Size			DIN Socket				DIN Spigot				JIS Socket			
d	mm	inch	d ₁	d ₂	l ₁	L	z	d	t	l ₁	L	d ₃	l ₂	1/T
20	16	1/2	19.3	19.5	14.5	41.5	7	20	2.5	18.5	54	22.11	20	1/34
25	20	3/4	24.3	24.5	16	53	13	25	2.7	22	68.5	26.13	24	1/34
32	25	1	31.3	31.5	18	59	14	32	3.0	22.5	74.5	32.16	27	1/34
40	30	1 1/4	39.2	39.45	20.5	65.5	15	40	3.7	26	83	38.19	30	1/34
50	40	1 1/2	49.2	49.45	23.5	74.5	14	50	4.6	32	97	48.21	37	1/37
63	50	2	62.1	62.5	27.5	92	22.5	63	5.8	36	108.5	60.25	42	1/37

PRODUCT MODEL CODE LIST

Type	Model	Material	Rubber	Size
I	**	P	*	***
⋮	⋮	⋮	⋮	⋮
I IAM LOCK	SO Socket	P PP	E EPDM	015 15mm
	9L Elbow		V FKM	I
	TE Tee			025 25mm
	SP Multi-Spigot			020015 20×15mm
				025015 25×15mm
				025020 25×20mm

IAM LOCK™

Simplified installation of PP Pipe



Features

- No need for tools and maintenance materials for installation.
- Easy installation as inserting pipe and tightening nut.
- All parts where solution contacts are plastic so no need to worry about corrosion.

Applicable Range

Cannot be used in the negative pressure of working temperature range of 0 to 90°C.

Working Temperature	20°C	40°C	60°C	80°C	90°C
Maximum Working Pressure MPa	1.0	0.70	0.48	0.23	0.20

Applicable Pipe

PP Pipe with DIN8077 (PN10)

Easy installation without fusing!

We received many comments that PP pipe installation and connection requires a special fusion machine and power source and is not easy on site where working space is small. Then **ASAHI V IAM LOCK™** is developed to make the installation more easier.

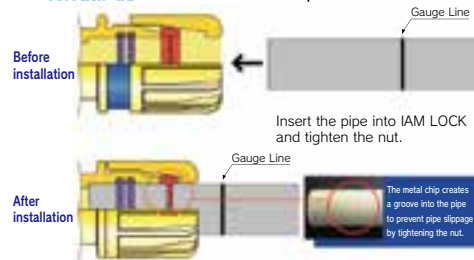

Product Standard List

	Socket	90° Elbow	Tee	Multi-Spigot
Size				
15 (d 20)	●	●	●	●
20 (d 25)	●	●	●	●
25 (d 32)	●	●	●	●
20×15 (d 25×d20)	●			
25×15 (d 32×d20)	●			
25×20 (d 32×d25)	●			

Basic Property

Features		Value	Unit	Test Method
Specific Gravity		0.91 – 0.92	—	JIS K 7112
Tensile Strength (Yield)		35	MPa	JIS K 7113
Tensile Strength (Breakage)		> 150	%	JIS K 7113
Tensile Elasticity		1340	MPa	JIS K 7113
Izod Impact Value	23°C	10 – 13	KJ/m ²	JIS K 7110
(With notch)	0°C	3 – 5		
	-20°C	3 – 4		
Specific Heat		2.2	J/g°C	JIS K 7123
Heat Conductivity		0.21	W/m·K	JIS A 1412
Vicat Softening Point		158	°C	JIS K 7206
Linear Expansion Coefficient		1.1×10 ⁻⁴	1/°C	
Deflection Temperature Under Load 0.45MPa		106	°C	JIS K 7191
Volume Resistivity		2.2×10 ¹⁶	Ω·cm	JIS K 6911
Permittivity		2.4	—	JIS K 6911
Water Absorption	23°C	< 0.05	%	JIS K 7209

* Data in this document are purely reference values and changes slightly depending on a production method, etc. of the test piece. Please be noted that these data cannot be applied to products directly.

Maximum Working Pressure by Temperature (Relationship of Temperature, Pressure and Service Life)

ASAHI PP pipe has a creep phenomenon specific to plastics, and the strength under a specific pressure is involved in temperature and time.

Relationship between Working temperature/Period and Maximum Working Pressure

(SDR11/PN10)

(Unit: MPa)

Working Temperature		10°C	20°C	30°C	40°C	50°C	60°C	70°C	80°C	90°C
Service Life	1 year	1.00	1.00	1.00	0.90	0.77	0.64	0.50	0.41	0.33
	5 years	1.00	1.00	0.96	0.81	0.69	0.57	0.44	0.35	0.24
	10 years	1.00	1.00	0.92	0.78	0.66	0.54	0.42	0.29	0.20
	25 years	1.00	1.00	0.87	0.73	0.62	0.51	0.35	0.23	—
	50 years	1.00	1.00	0.83	0.70	0.59	0.48	0.30	—	—

(SDR26/PN4)

(Unit: MPa)

Working Temperature		10°C	20°C	30°C	40°C	50°C	60°C	70°C	80°C	90°C
Service Life	1 year	0.40	0.40	0.40	0.36	0.31	0.25	0.20	0.17	0.13
	5 years	0.40	0.40	0.38	0.33	0.27	0.23	0.18	0.14	0.10
	10 years	0.40	0.40	0.37	0.31	0.26	0.22	0.17	0.12	0.08
	25 years	0.40	0.40	0.35	0.29	0.25	0.20	0.14	0.09	—
	50 years	0.40	0.40	0.33	0.28	0.23	0.19	0.12	—	—

* Values in the table are maximum working pressure in water and are not applicable for chemical solutions other than water.

* These values are calculated based on a simple work condition (temperature and pressure are consistent and no influence of ultraviolet rays) with safety factor of 2 at the time of elapse of service life. (Max.=1.0 MPa)

* These data are experimental values and do not guarantee the performance.

* These figures are not applicable to processed products.

* Assume maximum working pressure of threaded connection part to be 75% of this value.

Dissolution

ASAHIAV PP Pipe & Fittings use hygienic materials with less effusion of fluid. Because of this, they exert a high level of eluting capability close to PVDF used for high purity lines.

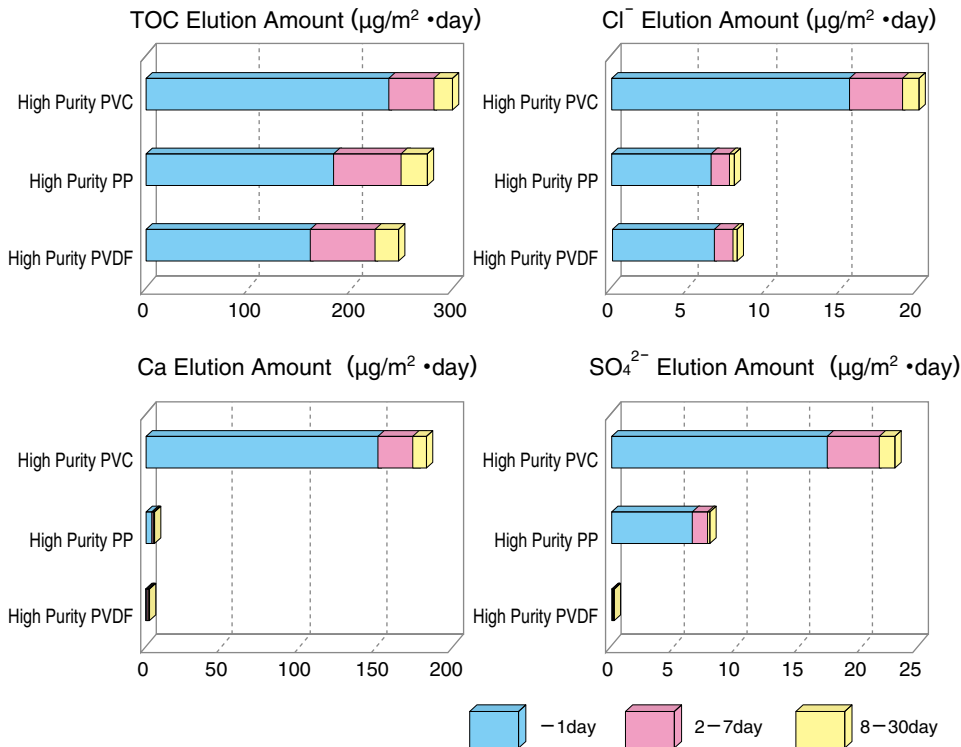

* Testing temperature: 23°C

* Subject to "High Purity Water Closing Method" (Ultra Clean Society)

* Data above are experimental values and do not guarantee the performance.

Combustibility

Combustion product of Polypropylene only contains components of the material such as C (Carbon), H (Hydrogen) and O (Oxygen). Therefore, there is no emission of hazardous substances such as dioxin.

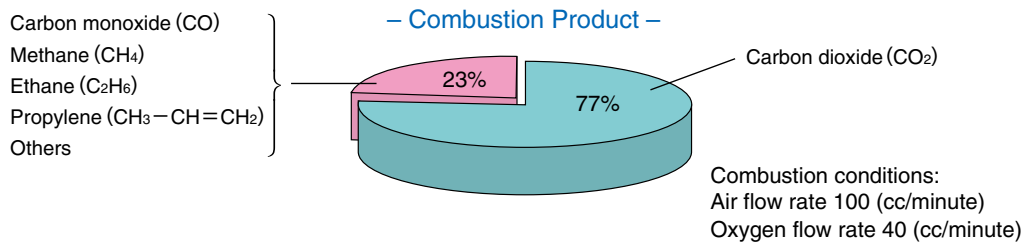

* Data above are experimental values and do not guarantee the performance.

Weatherproof

ASAHI In regards to weatherproof of PP Pipe & Fittings, even though the extension ratio was lowered due to an influence of the deterioration part on the surface, the tensile strength was not lowered from the measurements of tensile strength and extension ratio after an acceleration test by Sunshine Weather Meter. Therefore, it is expected to have equivalent or longer service life than PVC. However, it is recommended, as a basic installation method, to provide an appropriate covering for the exposed piping area where direct sunlight hits.

- Acceleration Test Data by Sunshine Weather Meter -

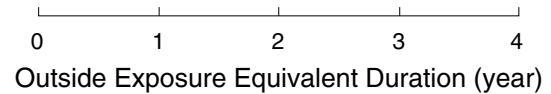
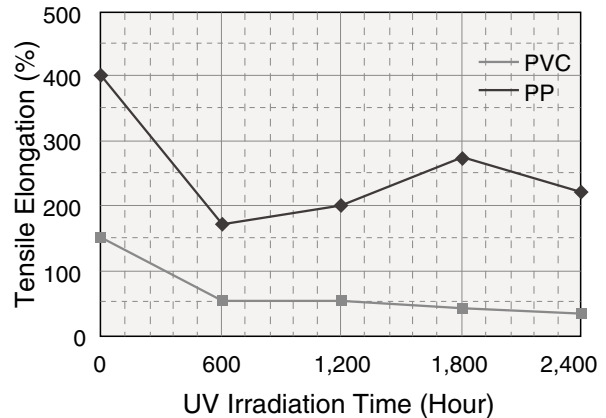
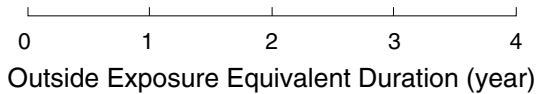
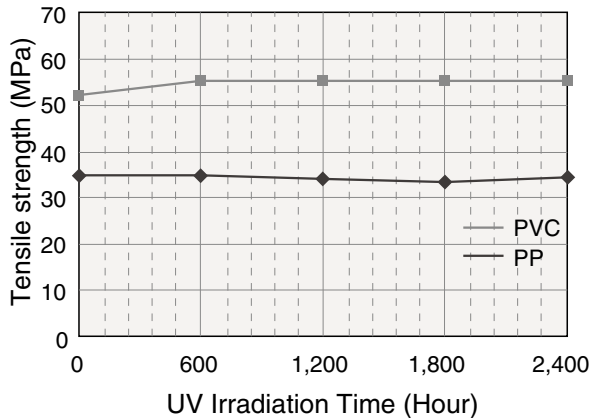

Test Method: JIS K 7350-2 "Exposure Test using Plastic-Experiment Room Light Source"
 JIS K 7113 "Plastic Tensile Test Method"

(Reference) Surface Deterioration Thickness after Acceleration Test

UV Irradiation Time (Hour)	600	1,200	1,800	2,400
Surface Deterioration Thickness (mm)	0.2	0.2	0.2	0.2

* Data above are experimental values and do not guarantee the performance.

PPLEX Pipe

Features

- Small Heat Expansion

Piping meandering phenomenon is restrained with a small expansion coefficient similar to PVC (7×10^{-5}).

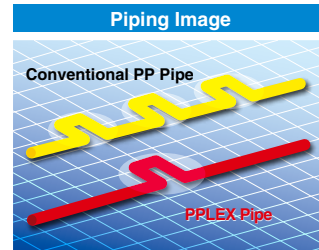
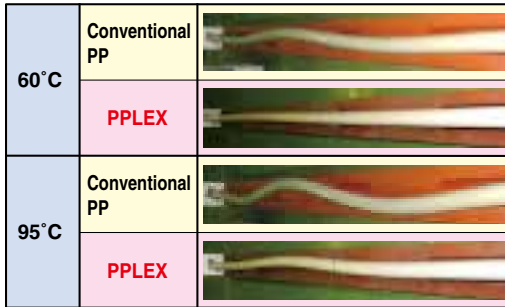

Expansion/contraction treatment is reduced as expansion is restrained and it is effective in reducing the installation expense.

- Increased Heat-Resistance

Heat-resistance improved compared to conventional PP materials. It is an excellent and safe material with no degradation of physical property even in the high temperature range.

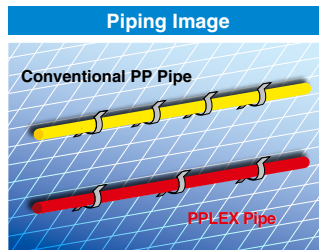
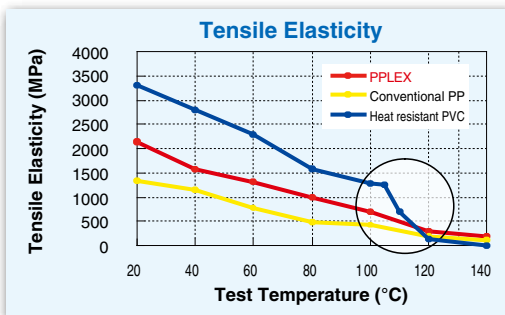

Reduced piping deflection leads to wider support intervals so it is effective to reduce the number of support hardware.

- Increased Weatherproof

With our mixing ratio, weatherproof improved dramatically and the service life in the outdoor exposed condition is longer than PVC.

Weatherproof Test: UV irradiation equivalent to 2 years of outside exposure

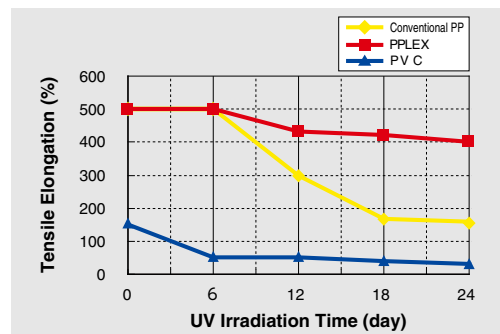
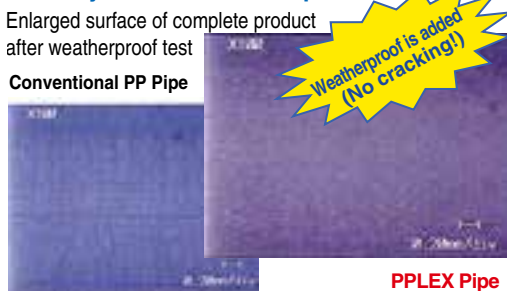

Product Lineup

Size (mm)	15	20	25	32	40	50	65	80	100	125	150	200
Product Display	d20	d25	d32	d40	d50	d63	d75	d90	d110	d140	d180	d225
PN10	○	○	○	○	○	○	○	○	○	○	○	○

* Use socket-type fitting for installation of PPLEX pipe. Spigot-type fitting cannot be used (butt fusion).

Chemical-resistance

PP Pipe & Fittings have an excellent durability against acid, alkali and some organic solvents. In addition, they exert favorable chemical-resistance in a high temperature range.

In addition to the chemical-resistance shown below, things such as temperature, concentration, pressure, etc. of solvent need to be considered at the time of making a selection. If you have any concerns, it is recommended to conduct a proof test.

Please contact us for chemicals, etc. not listed in the table.

Chemicals	Molecular Formula	Type	Concentration (%)	Chemical-resistance		State
				20°C	60°C	
Potassium hydroxide	KOH	Alkali	25	◎	◎	Solution
Sodium hydroxide	NaOH	Alkali	50	◎	◎	Solution
			15	◎	◎	Solution
			5	◎	◎	Solution
Ammonia gas	NH ₃	Alkali	100	◎	○	Gas
Ammonium hydroxide	NH ₄ OH	Alkali	10	◎	◎	Solution
			40	◎	◎	Solution
Ethanol	CH ₃ CH ₂ OH	Alcohol	96	◎	○	
Methanol	CH ₃ OH	Alcohol	pure	◎	◎	
Acetic acid	CH ₃ COOH	Acid	50	◎	◎	Solution
			10	◎	◎	Solution
Hydrogen sulfide	H ₂ S	Acid	dry	◎	◎	Gas
			60	◎	◎	Solution
Sulfuric acid	H ₂ SO ₄	Acid	50	◎	◎	Solution
			30	◎	◎	Solution
			10	◎	◎	Solution
Phosphoric acid	H ₃ PO ₄	Acid	85	◎	◎	Solution
			50	◎	◎	Solution
			10	◎	◎	Solution
Hydrochloric acid	HCl	Acid	20	◎	◎	Solution
			5	◎	◎	Solution
Fluorine	HF	Acid	30	◎	◎	Solution
			10	◎	◎	Solution
Nitric acid	HNO ₃	Acid	65	×		Solution
			10	○	×	Solution
Hydrogen peroxide water	H ₂ O ₂		50	○	×	Solution
			10	○	○	Solution
Potassium permanganate	KMnO ₄		18	△	△	Solution
			6	○		Solution
Tomato juice		Foods		◎	◎	Liquid
Vegetable/animal oil		Foods		◎	△	
Styrene	CH ₂ CHC ₆ H ₅	Aromatic	pure	△	×	Liquid
Phenol	HOC ₆ H ₅	Aromatic	pure	×		
Polyaluminum chloride	(AlCl ₃) _n			◎	◎	Solution
Ferric chloride	FeCl ₂		Dilution	◎	◎	Solution
Salt (Sodium chloride)	NaCl		Dilution	◎	◎	
			Saturation	◎	◎	

《Legends》

- ◎ Completely or almost no influence.
- Slightly influenced.
- △ Influenced.
- × Dramatically influenced.
- Vacant Not confirmed or no actual results.

Results of Performance Test

① Limit Hydraulic Fracturing Test

Purpose: Check the short-term strength of pipe and fittings



<Before test>



<After test>

Result: No abnormalities such as leakage from the fused part are seen.

(Reference) Relationship between temperature and burst pressure

Temperature (°C)	20	40	60	80
Burst Pressure (MPa)	8.4	6.8	5.6	4.2

Notes: PP pipe has no relationship with the size and has almost the same strength.

② Pulling Test

Purpose: Check the strength of the pipe-to-fitting fused part against a pulling load (Pulling speed: 10mm/min)



<Before test>



<After test>

Results: No slippage or damage of the fused part.

③ Bending Test

Purpose: Check the strength of the pipe-to-fitting fused part against a bending load (Bending angle (Angle of attack): 15°)



<Before test>



<After test>

Results: No slippage or damage of the fused part.

④ Flattening Test

Purpose: Check the air-tightness when the pipe is flattened near the fused part (Flatten rate: 30%, Water pressure: 2.5 MPa)



<Before test>



<After test>

Results: No delamination or leakage from the fused part.

⑤ Pulsation Test

Purpose: Check The strength against repeated pressure (0~3.0 MPa) on the fitting (Water temperature: 10°C, Number of times: 1,000,000 times)



<Test view>

Result: No abnormalities such as breakage of the fitting and leakage from the fused part are seen.

Notes: Data above are experimental values and do not guarantee the performance.

Piping Support Intervals

Changes by pipe wall-surface temperature, size and fluid specific gravity. Support intervals by temperature are shown in the following table.

■ In the case of fluid being liquid

Unit: mm

		PN10/SDR11							
Size (mm)	Product Display	Temperature (°C)							
		20°C	30°C	40°C	50°C	60°C	70°C	80°C	90°C
15	d20	530	510	500	480	460	450	430	410
20	d25	590	570	550	530	510	500	480	460
25	d32	660	640	620	600	570	560	540	520
32	d40	750	720	700	670	650	630	610	580
40	d50	830	810	780	750	720	700	680	650
50	d63	930	900	870	840	810	790	760	730
65	d75	1,020	980	950	920	880	860	830	800
80	d90	1,120	1,080	1,040	1,000	960	940	910	870
100	d110	1,230	1,190	1,150	1,110	1,070	1,040	1,010	960
125	d140	1,390	1,340	1,300	1,250	1,200	1,170	1,140	1,090
150	d180	1,580	1,520	1,470	1,420	1,370	1,330	1,290	1,230
200	d225	1,760	1,700	1,650	1,590	1,530	1,490	1,440	1,380

*) Calculated by setting water (specific gravity=1) as fluid and deflection at 5 mm.

Unit: mm

		PN4/SDR26							
Size (mm)	Product Display	Temperature (°C)							
		20°C	30°C	40°C	50°C	60°C	70°C	80°C	90°C
125	d140	1,160	1,120	1,090	1,050	1,010	980	950	910
150	d180	1,320	1,280	1,230	1,190	1,140	1,110	1,080	1,030
200	d225	1,470	1,430	1,380	1,330	1,280	1,240	1,210	1,150

*) Calculated by setting water (specific gravity=1) as fluid and deflection at 5 mm.

■ In the case of duct pipe

Unit: mm

		PN10/SDR11							
Size (mm)	Product Display	Temperature (°C)							
		20°C	30°C	40°C	50°C	60°C	70°C	80°C	90°C
15	d20	700	680	660	630	610	590	580	550
20	d25	790	760	740	710	680	660	640	620
25	d32	890	860	830	800	770	750	730	700
32	d40	1,000	960	930	900	860	840	810	780
40	d50	1,110	1,080	1,040	1,000	960	940	910	870
50	d63	1,250	1,210	1,170	1,120	1,080	1,050	1,020	980
65	d75	1,360	1,320	1,270	1,230	1,180	1,150	1,120	1,070
80	d90	1,490	1,440	1,400	1,340	1,290	1,260	1,220	1,170
100	d110	1,650	1,600	1,540	1,490	1,430	1,390	1,350	1,290
125	d140	1,860	1,800	1,740	1,680	1,610	1,570	1,520	1,460
150	d180	2,110	2,040	1,970	1,900	1,830	1,780	1,730	1,650
200	d225	2,360	2,280	2,210	2,130	2,040	1,990	1,930	1,850

Unit: mm

		PN4/SDR26							
Size (mm)	Product Display	Temperature (°C)							
		20°C	30°C	40°C	50°C	60°C	70°C	80°C	90°C
125	d140	1,910	1,850	1,790	1,720	1,650	1,610	1,560	1,490
150	d180	2,170	2,090	2,020	1,950	1,870	1,830	1,770	1,690
200	d225	2,420	2,340	2,260	2,180	2,100	2,050	1,980	1,890

Figures above are support intervals for straight pipe. Consideration is required when adding flanges, valves, etc. If the fluid specific gravity is different, the support intervals need to be shortened by multiplying with a value in the table below.

Specific Gravity	1.00	1.25	1.50	1.75
Lowering Coefficient	1.00	0.96	0.93	0.90

Expansion Measure

Since PP pipes have a large linear expansion coefficient compared to other materials, an expansion/contraction measure is required in the case of piping temperature fluctuation.

Material	PP	PVC	PVDF
Linear Expansion Coefficient ($\times 10^{-4}/^{\circ}\text{C}$)	1.1	0.8	1.3

● Handling With Elbow

Stress caused by heat expansion/contraction is distributed by arranging piping two- and three-dimensional ways with elbows.

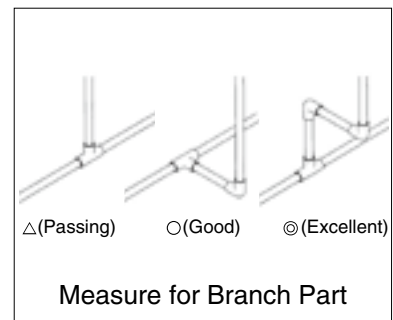
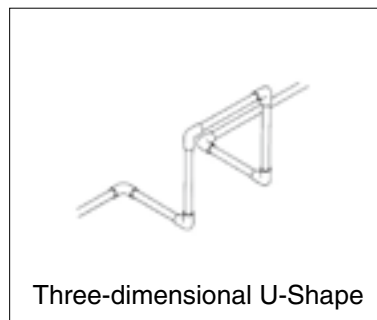
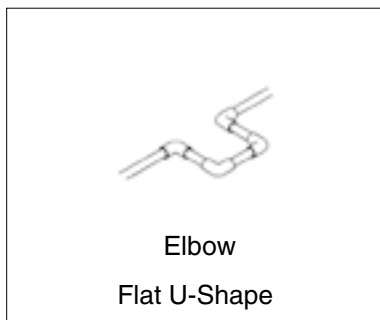

*) Actual design needs to be finalized after fully considering the piping stress in terms of fitting interval dimensions and pipe support locations.

Reducer Installation Procedure

In the case of size-reducing pipe

Reducer is a single-side type (socket+insert). Socket is required as shown below when connecting to pipe.

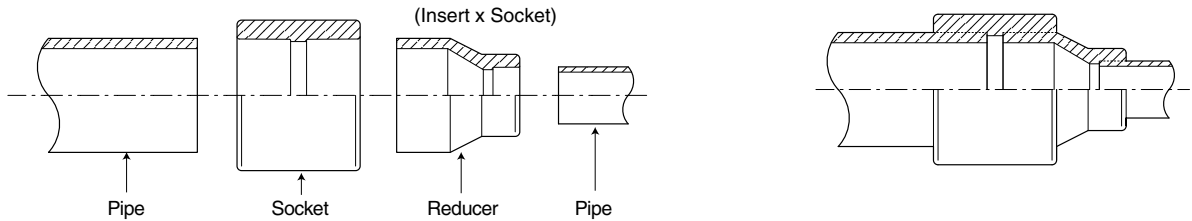

In the case of making reducer tee

Make a reducing tee combining tee (same diameter) and reducer.

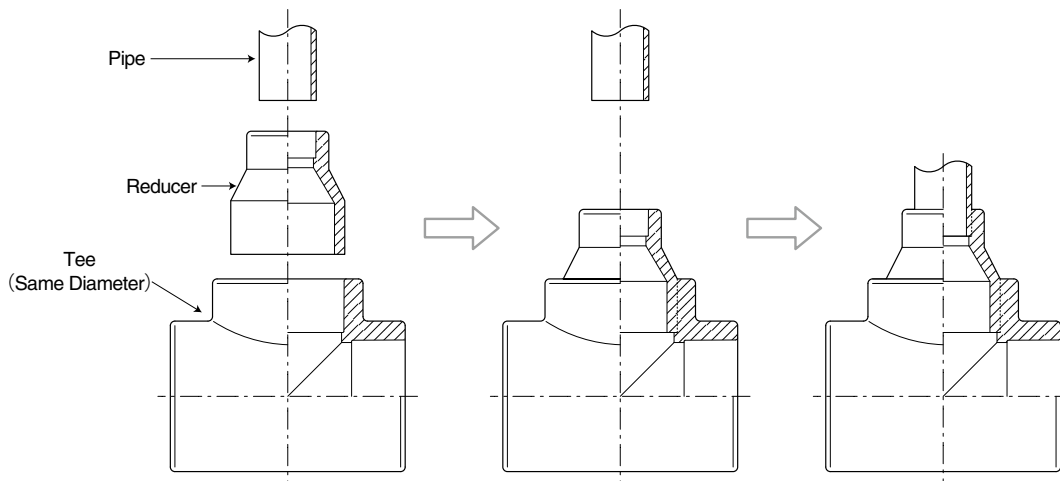

Piping Bolt Dimensions

Piping Bolt Dimensions Table

Size (mm)	Product Display	Bolt		L			
		Quantity	Size	BKF+BKF	BKF+DV	SF+SF	SF+DV
15	d20	4	M12	65	55	45	45
20	d25	4	M12	65	55	50	50
25	d32	4	M16	80	65	55	55
32	d40	4	M16	85	70	60	60
40	d50	4	M16	85	75	60	60
50	d63	4	M16	90	80	70	70
65	d75	4	M16	85	75	70	70
80	d90	8	M16	85	80	70	70
100	d110	8	M16	90	80	70	70
125	d140	8	M20	130	105	-	-
150	d180	8	M20	140	110	-	-
200	d225	12	M20	150	120	-	-



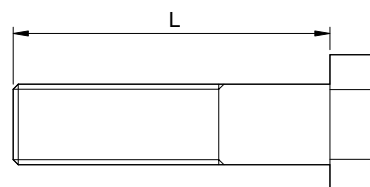

BKF: Flange Adaptor + Backing Flange

SF : Socket Flange

DV : Diaphragm Valve Type14, Type 15, Type72



Fusion Machine Specification

Description	R63 (TE Model)	PRISMA 125	AV225	AVEF200
Appearance				
Applicable Fitting	Socket Fitting	Socket Fitting	Socket Fitting	EF (Electro Fusion) Fitting
Features	<ul style="list-style-type: none"> • Manual fusion machine • Light and easy to carry • Workable in a small space (fusion at site is possible) 	<ul style="list-style-type: none"> • Mechanical fusion machine • Wide applicable sizes • Suitable for continuous work (prefab products) 	<ul style="list-style-type: none"> • Mechanical fusion machine • Lowered burden by hydraulic drive • Suitable for continuous work (prefab products) 	<ul style="list-style-type: none"> • Electric fusion machine • Light and easy to carry • Workable in a small space (fusion at site is possible)
Applicable Outer Diameter	15 – 50 mm (d20 – d63)	20 – 100 mm (d25 – d110)	125 – 200 mm (d140 – d225)	15 – 200 mm (d20 – d225)
Input Power Source	110 V / 50-60Hz	110 V / 50-60Hz	220 V / 50-60Hz	100 V / 50-60Hz
Maximum Power Consumption	800 W	1400 W	4100 W	2400 W
Dimensions	L360xW175xH50 mm	L1,500xW840xH1260 mm	L1400xW620xH890 mm	L320xW410xH370 mm
Weight	1.82 kg	100 kg	200 kg	10 kg

Installation Tools

Tools other than a fusion machine are required.



①, ②, ⑤, ⑥, ⑦, ⑨: REX INDUSTRIES CO., LTD. } These are the parts manufactures.
 ⑧: MCC Corporation

Installation Steps Socket Fusion R63

Applicable Range 15 – 50 mm
(d20 – d63)



- ① Preparation of Fusion Machine
1) Set fusion machine on a flat place.
Notes: Fix to a table, etc., if necessary.



- 2) Fix heater face and turn on the power.
Notes: • No biting of foreign objects.
• Tighten firmly without looseness.
• The power will turn on when the cable is inserted.



- ② Pipe Cutting and Cleaning
1) Cut pipe at necessary length with a pipe cutter.



- 2) Check for no scratches and dirt on pipe and clean, if any.
Notes: It shall be cut at right-angle. Cut and remove any harmful scratches.



- ③ Entry of Insertion Amount Line
1) Enter a gauge line for insertion depth.



- ④ Chamfering of Pipe End
1) Chamfer the pipe end.
Notes: Chamfer using a special tool.



- ⑤ Pipe & Fittings Cleaning
1) Clean the pipe cut surface and the internal face of fitting socket with a special paper towel fully impregnated with acetone.
Notes: Clean with bare hands and check that grease, etc. is removed from the fused face. Do not touch the fused face after cleaning.



- ⑥ Heater Check
1) Check the temperature is $260 \pm 10^\circ\text{C}$ using a surface thermometer.
Notes: • Measure at several locations and check for no fluctuation.
• If the temperature is out of the specified range, adjust with the temperature selector.



- 2) Clean the heater face surface.



- ⑦ Heat Fusion
1) Insert pipe & fittings into heater face to the insertion gauge line and heat/fuse for specified time.
Notes: • Insert at a certain speed.
• Do not insert while twisting.



- ⑧ Removal, Crimping, Cooling
1) After completing heat fusion, remove pipe & fittings from heater face immediately, insert it by hand, and then hold it in that condition.
Notes: • Time from completion of heat fusion to completion of crimping shall be done within the specified conversion time.
• Do not pull or twist after completing crimping.
• Do not apply any load on the fused part until completely cooled.



- ⑨ Inspection
1) Check that bead is consistently applied along the entire circumference.
2) Check for no scratches, abnormalities, etc. on the connected part.
Notes: If any defects are seen, cut the connected part and redo from the beginning.



(Reference)



↑ Heater faces with 2 sizes can be installed at the same time.

Notes: Refer to P.172 for the fusion conditions.



① Preparation of Fusion Machine
1) Set fusion machine on a flat place.

2) Fix heater face and turn on the power.

Notes: • No biting of foreign objects.
• Tighten firmly without looseness.

3) Match selector to fusion size.

4) Match clamp to fusion size.

Notes: 50 mm or less: Small-end side,
65 mm or over: Large-end side



3) Protrude pipe until the pipe end surface becomes the straight line with the fitting socket end and then fix. (Common for all sizes)

4) Clean the pipe cut surface and the internal face of fitting socket with a special paper towel fully impregnated with acetone.

Notes: Clean with bare hands and check that grease, etc. is removed from the fused face. Do not touch the fused face after cleaning.



⑤ Heater Check

1) Check that the temperature is $260 \pm 10^\circ\text{C}$ using a surface thermometer.

Notes: • Measure at several locations and check for no fluctuation.

• If the temperature is out of the specified range, adjust with the temperature selector.

2) Clean the heater face surface. Check no dirt and then set at a specified location.



② Pipe Cutting and Cleaning

1) Cut pipe at a necessary length with a pipe cutter.

2) Check for no scratches and dirt on pipe and clean, if any.

Notes: It shall be cut at right-angle. Cut and remove any harmful scratches.



③ Cutting of Fused Face

1) Enter a gauge line for insertion depth.

2) Cut the surface from pipe end to gauge line with a scraper.

Notes: No need for sizes of 50 mm or less.

3) Chamfer the pipe end.

Notes: • After cutting, check for no scratches on the fused surface.
• If some uncut areas remain, cut again.
• Use special tools for surface cutting and chamfering.



⑥ Heat Fusion

1) Forward clamp, insert pipe & fittings into heater face (to the stopper of fusion machine), and heat/fuse for the specified time.

Notes: Insert at a certain speed.



⑦ Heater Removal, Crimping, Cooling

1) After completing heat fusion, retract clamp immediately and remove heater.

2) After removing heater, move clamp forward to the stroke end.

Notes: Time from completion to completion of crimping shall be done within the specified conversion time.

3) After completion of crimping, cool it for the specified time while clamped.

4) Remove from clamp and cool it for the specified time.

Notes: Do not apply any load on the fused part until completely cooled.



④ Fixing and Cleaning of Pipe & Fittings

1) Fix fitting at a position where the fitting end surface touches the clamp flange.

Notes: For 65 mm or over, use non-slip spike of auxiliary clamp.

2) Forward clamp until it touches the button while pressing the position button.



⑧ Inspection

1) Check that bead is consistently applied along the entire circumference.

2) Check for no scratches, abnormalities, etc. on the connected part.

Notes: If any defects are seen, cut the connected part and redo from the beginning.

Notes: Refer to P.172 for the fusion conditions.

Installation Steps Socket Fusion AV225

Applicable Range 125 – 200 mm
(d140 – d225)



- ① Preparation of Fusion Machine
- 1) Set fusion machine on a flat place.
 - 2) Wire the power cable from the main unit and hydraulic unit to heater.
 - 3) Fix heater face and turn on the power.
- Notes: • No biting of foreign objects.
• Tighten firmly without looseness.



Main Power Source Heater Power Source Temperature Adjustment Selector



- 4) Install fusion-size liner (pipe liner, fitting liner).
- 5) Operate the unit lever forward and adjust the pressure adjustment selector to 5 MPa while making clamp touching and checking the pressure gauge.

Notes: Check that the filter regulator is fully closed.



Pressure Gauge Filter Regulator Pressure Gauge Selector

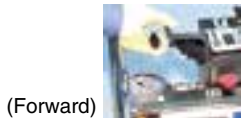

- ② Pipe Cutting and Cleaning
- 1) Cut pipe at a necessary length with a pipe cutter.
 - 2) Check for no scratches and dirt on pipe and clean, if any.

Notes: Check that it was cut at right-angle. Cut and remove any harmful scratches.



- ③ Cutting of Fused Face
- 1) Mark gauge lines for insertion length and thrust length using a gauge.

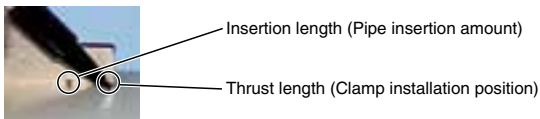

- 2) Cut the surface from pipe leading end to insertion gauge line with a scraper.
- 3) Chamfer the pipe end.



Notes: • After cutting, check for no scratches on the fused surface.
• If some uncut areas remain, cut again.
• Use special tools for surface cutting and chamfering.



- ④ Fixing and Cleaning of Pipe & Fittings
- 1) Fix fitting at a specified location.
 - 2) Fix pipe in alignment with thrust gauge line.
 - 3) Forward pipe close to fitting and check the alignment of pipe shaft. (Up/down and right/left)
 - 4) Clean the pipe cut surface and the internal face of fitting socket with a special paper towel fully impregnated with acetone.



(Fitting fixing) (Pipe fixing)



- ⑤ Heater Check
- 1) Check that the temperature is $260 \pm 10^\circ\text{C}$ using a surface thermometer.
 - 2) Clean the heater face surface. Check no dirt and then set at a specified location.



- ⑥ Heat Fusion
- 1) Forward clamp, insert pipe & fittings into heater face, and heat/fuse for the specified time.
- Notes: Insert at a certain speed.



- ⑦ Heater Removal, Crimping, Cooling
- 1) After completing heat fusion, retract clamp immediately and remove heater.
 - 2) After removing heater, move clamp forward to the stroke end.
 - 3) After completion of crimping, cool it for the specified time while clamped.
 - 4) Remove from clamp and cool it for the specified time.
- Notes: Time from completion to completion of crimping shall be done within the specified conversion time.
Notes: Do not apply any load on the fused part until completely cooled.



- ⑧ Inspection
- 1) Check that bead is consistently applied along the entire circumference.
 - 2) Check for no scratches, abnormalities, etc. on the connected part.
- Notes: If any defects are seen, cut the connected part and redo from the beginning.



Notes: Refer to P.172 for the fusion conditions.

Installation Steps EF Installation AVEF200

Applicable Range 15 – 200mm
(d20 – d225)



- ① Pipe Cutting
Cut pipe at a necessary length with a pipe cutter.
Note) Diagonal cutting of 5 mm or over may cause installation failure.



- ② Pipe Cleaning Wipe off dirt or the like attached on pipe.

③ Entry of Insertion Gauge Line

Mark insertion length (fitting overall length/2) in the circumference direction with a permanent marker, etc. Reference) Useful to use cardboard, etc.

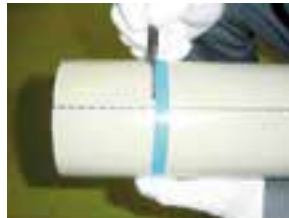

■ Insertion Length

Size	d20 (15)	d25 (20)	d32 (25)	d40 (32)	d50 (40)	d63 (50)	d75 (65)
(mm)	35	39	40	46	52	59	66
Size	d90 (80)	d110 (100)	d140 (125)	d160 (150)	d180 (150)	d225 (200)	
(mm)	73	81	92	95	106	106	



- ④ Entry of Fusion Surface
Mark the surface where fusion to fitting would be made with a permanent marker, etc.



- ⑤ Cutting of Fusion Surface (Scrape)
Cut until the marked part completely disappears with a PP special scraper.
Note) No cutting or uneven cutting may cause fusion failure.



- ⑥ Cleaning of Fusion Surface of Pipe & Fittings
Clean the fusion surface of pipe and fitting with a special paper towel fully impregnated with acetone.
Note) Do not use tissue paper or cloth.



- ⑦ Fixing of Fitting and Pipe
Insert pipe into fitting to the insert gauge line and fix securely using clamp.
Note) Insufficient pipe insertion may cause fusion failure.
Note) Misalignment of pipe and fitting (oblique insertion) may cause fusion failure. Check for no angle misalignment and fix clamp.

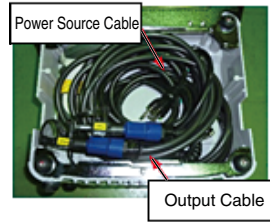

- ⑧ Fusion Preparation
1) Open the cable housing cover on the back of unit body and take out the power source cable, output cable and bar code reader.

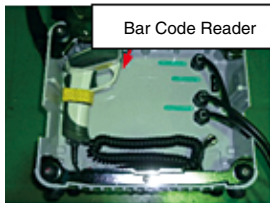

- 2) Connect the power source cable to AC 100V power source.
Notes: In the case of using an extension cable, use the one provided (10x3.5mm²).
Notes: Do not connect other equipment to the extension cable.

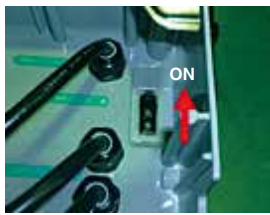

- 3) Turn on the switch of leakage beaker (main power source) and close the housing cover.



- ⑨ Fusion
1) Press the "Power" button on the operation panel. The liquid crystal display shows as follows.



- 2) Connect fitting terminal and adapter on the leading end of output cable.
Warning: Caution for electric shocks!!
Make sure to put a cap on terminals not connected to adapter when working. Touching the metal part inside will give electric shocks.



- 3) Read bar code attached on fitting using a bar code reader.
Reference) You can read bar code in the distance of 5 to 15 cm.
Reference) Refer to the next section for entering bar code key.
4) Check for no error in description on the liquid crystal display and press the "Start" button.

Leave 5 to 15 cm

- Reference) Once energization is properly completed, completion buzzer goes off 8 times and cooling time will be displayed on the liquid crystal display.



- ⑩ Cooling
After fusion (energization), remove adapter from fitting and then remove clamp after the elapse of cooling time.
Notes: Do not move the fused part or move clamp until the end of cooling time.

Fusion Conditions

■ Socket Fusion R63

Size (mm)	Product Display	Insertion length (minimum) (mm)	Heat Fusion Time (sec)	Conversion Time (sec)	Cooling Time (sec)	
					Retaining	Total
15	d20	14.5	5	4	6	120 (2min)
20	d25	16.0	7	4	10	120 (2min)
25	d32	18.0	8	6	10	240 (4min)
32	d40	20.5	12	6	20	240 (4min)
40	d50	23.5	12	6	20	240 (4min)
50	d63	27.5	24	8	30	360 (6min)

■ Socket Fusion PRISMA125

Size (mm)	Product Display	Insertion length (minimum) (mm)	Heat Fusion Time (sec)	Conversion Time (sec)	Cooling Time (sec)	
					Retaining	Total
20	d25	16.0	7	4	10	120 (2min)
25	d32	18.0	8	6	10	240 (4min)
32	d40	20.5	12	6	20	240 (4min)
40	d50	23.5	12	6	20	240 (4min)
50	d63	27.5	24	8	30	360 (6min)
65	d75	31.0	30	8	30	360 (6min)
80	d90	35.5	40	8	40	360 (6min)
100	d110	41.5	50	10	50	480 (8min)

■ Socket Fusion AV225

Size (mm)	Product Display	Heat Fusion Time (sec)		Conversion Time (sec)	Retaining Time (sec)	Cooling Time (min)
		PN10/SDR11	PN4/SDR26			
100	d110	60	–	20	60	8
125	d140	90	45	20	90	8
150	d180	120	60	20	120	10
200	d225	150	75	20	150	10

* Heater temperature: 260±10°C

* 100 mm: Only reducer (125x100 mm) is fusible.

<Use Precautions>

* Heat Fusion Time: Time from completion of insertion

* Conversion Time: Time from completion of heating to completion of crimping

* Retaining Time: Time while fixed on fusion machine clamp (For R63, time while fixed manually)

* Cooling Time: Time to cool without clamp

EF Installation AVEF200

EF Controller (Fusion Machine)



No.	Accessories	Dimensions	Weight
①	EF Controller	L202×W310×H310 mm	10.0kg
②	Extension Cable	Length 10 m (Thickness 3.5mm ²)	2.7kg
③	Housing Case	L320×W410×H370 mm	1.5kg
			Total: 14.2kg



Insertion Length

Size (mm)	Product Display	Insertion Length (One Side) (mm)
15	d20	35
20	d25	39
25	d32	40
32	d40	46
40	d50	52
50	d63	59
65	d75	66
80	d90	73
100	d110	81
125	d140	92
150	d180	106
200	d225	106

Description of Bar Code

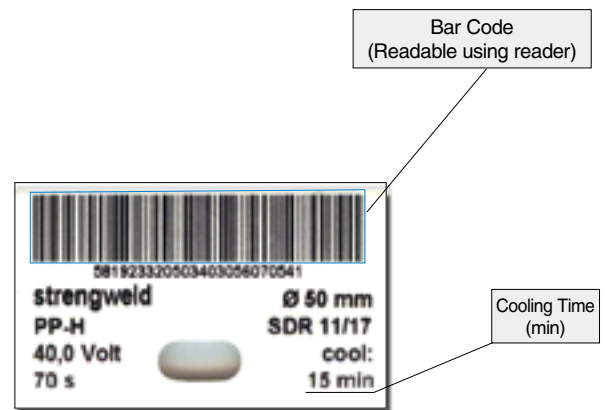

Precautions

- This is our designated EF Controller (energization control device) for PP Pipe EF Fitting (Socket).
- Only personnel received training from our instructors can use the device.
- Sufficiently inspect the main unit, cable and other parts for no damage before use.
- Do not drop or give a great impact to this machine. It may cause damage or failure.
- Do not disassemble or modify. It may cause accident or injury.
- Make sure to connect the ground. It may cause electric shocks.
- Do not look at the laser light of bar code reader directly. It may cause damage to the eyes.
- Acetone is categorized into Type 4 Hazardous Materials and flammable. Follow the laws and regulations and municipal ordinances for storage.
- The blades of pipe cutter and scraper are sharp. Be cautious of handling and do not touch the blade with bare hands.
- In the case of removing or cleaning the adaptor or bar code, unplug the power source.
- Store in the housing case when not using and do not leave under the direct sunlight.
- When returning the machine, enclose the main unit and extension cable in the provided housing case and then return.

Butt Fusion Machine/Installation Tools

■ Butt Fusion Machine Specification



Item	MINIPLAST 2
Applicable Outer Diameter (Inner Diameter mm)	20 (15mm) – 110 (100mm)
Input Power Source	100V
Dimensions (mm)	450x300x365
Weight (kg)	11.6kg



Item	4600
Applicable Outer Diameter (Inner Diameter mm)	75 (65 mm) – 250 (200 mm)
Input Power Source	200V
Dimensions (mm)	950x850x570
Weight (kg)	83kg

■ Installation Tools

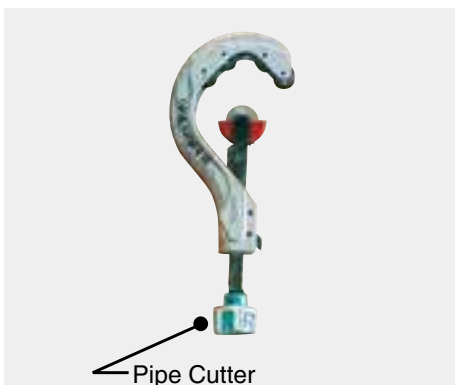

* For operation method and tool selection, refer to the Installation Procedure.

Related Products

Gasket	P.176
Bellmouth	P.181
Opening/Closing Base	P.182
Gauge Flange	P.183
Diaphragm Type Pressure Gauge	P.185
Bolt/Nut/Washer	P.186
Saddle	P.188
Adhesive/Lubricant	P.189
Air-Conditioning Drain Pipe & Fittings, Saddle	P.191



Related product

PRODUCT MODEL CODE LIST

Type	Model	Rubbers	Standard	Size
G	*	*	*	***
⋮	⋮	⋮	⋮	⋮
G Gasket	A Full Face N Inner Face	E EPDM F PVDF-Covering T PTFE-Covering 1 Viflon®F/ FKM-F 2 Viflon®C / FKM-C V FKM S SBR J EPDM (Lubricant Free) L PTFE (Lubricant Free)	1 JIS 10K 5 JIS 5K A ANSI D DIN W Waterworks	013 13mm I 350 350mm

AV Gasket Working Temperature Range

AV Gasket Type	Working Temperature Range
AV EPDM Gasket	-40 - 90°C
* AV CSM Gasket	-20 - 80°C
* AV NBR Gasket	-30 - 100°C
* AV IIR Gasket	-30 - 90°C
* AV FKM Gasket	-20 - 150°C
* AV SBR Gasket	5 - 35°C
AV PTFE-Covering Gasket	-40 - 120°C
AV PVDF-Covering Gasket	-40 - 120°C

<Use Precautions>

1. Values on the left are general working temperature range. It may be invasive depending on type, temperature, etc. of chemical solution.
2. Working temperature range for Viflon®F/FKM-F and Viflon®C/ FKM-C is same as FKM.
3. If insulation is required with EPDM gasket, specify "Insulation EPDM".
4. The marked (*) ones are build-to-order products.

- These are cast products so there is no unevenness in thickness and the surface is flat. The protrusion of dual-layer O-ring prevents leakage even when the surface pressure is low. Appropriate rubber hardness exerts an buffering effect against heat stress and piping stress. The material of high-quality virgin rubber extends duration of life.

AV Gasket Standard

Type	Standard	JIS 10K	JIS 5K	Waterworks	ANSI, DIN
Full Face Gasket		○	○	○	○
Inner-Face Gasket		○	○	○	—
PTFE-Covering Gasket		○	—	—	○
PVDF-Covering Gasket		○	—	—	○

<Use Precautions>

1. When using AV gasket for connecting metal-to-metal flange or resin-to-metal flange, use flat face (FF) metal flange. Using plane-seat flange (RF) may cause damage to gasket.
2. Some materials are not available for AV gasket depending on standard and type. For details, please contact our nearest office.

Full-Face Gasket (JIS 10K, JIS 5K)

PRODUCT MODEL CODE

JIS 10K	▶ G	A	Rubber Type	1	Size
JIS 5K	▶ G	A	Rubber Type	5	Size

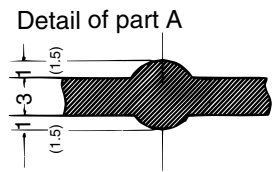
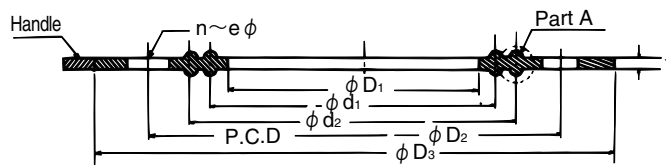

Dimensions in parenthesis show the case of 350 mm (14 inch).

Dimensions Table

(Unit: mm)

Size	Standard	D ₁ (Inner Diameter)	D ₂ (P.C, D)	D ₃ (Outer Diameter)	n	e	d ₁	d ₂	t
13	5K	15	55	73	4	12	22	34	3
	10K	15	65	88	4	15	22	37	3
15	5K	18	60	78	4	12	26	39	3
	10K	18	70	93	4	15	26	41	3
20	5K	22	65	83	4	12	30	44	3
	10K	22	75	98	4	15	32	47	3
25	5K	30	75	93	4	12	39	53	3
	10K	30	90	123	4	19	38	53	3
32	5K	37	90	113	4	15	45	60	3
	10K	37	100	133	4	19	50	65	3
40	5K	43	95	118	4	15	53	69	3
	10K	43	105	138	4	19	54	69	3
50	5K	54	105	128	4	15	64	79	3
	10K	54	120	153	4	19	68	83	3
65	5K	69	130	153	4	15	82	101	3
	10K	69	140	173	4	19	86	101	3
80	5K	80	145	178	4	19	93	112	3
	10K	80	150	183	8	19	98	112	3
100	5K	102	165	198	8	19	114	133	3
	10K	102	175	208	8	19	120	138	3
125	5K	127	200	233	8	19	142	165	3
	10K	127	210	248	8	23	145	166	3
150	5K	150	230	263	8	19	167	193	3
	10K	150	240	278	8	23	168	190	3
200	5K	198	280	318	8	23	215	240	3
	10K	198	290	328	12	23	216	247	3
250	5K	249	345	383	12	23	270	301	3
	10K	249	355	398	12	25	270	306	3
300	5K	300	390	428	12	23	318	349	3
	10K	300	400	443	16	25	324	352	3
350	5K	350	435	478	12	25	365	385	3
	10K	350	445	488	16	25	370	390	3

Full-Face Gasket (DIN, ANSI, Japan Waterworks)

MODEL CODE	DIN PN10	G	A	Rubber Type	D	Size
	ANSI CLASS 150	G	A	Rubber Type	A	Size
	Waterworks(SBR)	G	A	S	W	Size

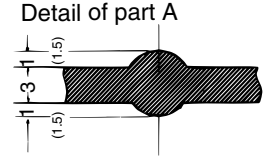
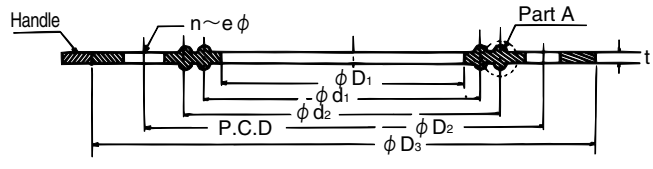

Dimensions in parenthesis show the case of 350 mm (14 inch).

For DIN PN10

■ Dimensions Table

(Unit: mm)

Size	D ₁	D ₂	D ₃	n	e	d ₁	d ₂
15	18	65	93	4	14	26	41
20	22	75	103	4	14	32	47
25	30	85	113	4	14	38	53
32	37	100	138	4	18	50	65
40	43	110	148	4	18	54	69
50	54	125	163	4	18	68	83
65	69	145	183	4	18	86	101
80	80	160	198	8	18	98	112

Size	D ₁	D ₂	D ₃	n	e	d ₁	d ₂
100	102	180	218	8	18	120	138
125	127	210	248	8	18	145	166
150	150	240	283	8	22	168	190
200	198	295	338	8	22	216	247
250	249	350	393	12	22	270	306
300	300	400	443	12	22	324	352
350	350	460	503	16	22	370	390

For ANSI Class 150

■ Dimensions Table

(Unit: inch)

Size	D ₁	D ₂	D ₃	n	e	d ₁	d ₂
15	0.71	2.38	3.43	4	0.63	1.02	1.61
20	0.87	2.76	3.78	4	0.63	1.26	1.85
25	1.18	3.13	4.17	4	0.63	1.50	2.09
32	1.46	3.50	4.53	4	0.63	1.97	2.56
40	1.69	3.88	4.92	4	0.63	2.13	2.72
50	2.13	4.74	5.91	4	0.75	2.68	3.27
65	2.72	5.49	6.93	4	0.75	3.39	3.98
80	3.15	6.00	7.44	4	0.75	3.86	4.41

Size	D ₁	D ₂	D ₃	n	e	d ₁	d ₂
100	4.02	7.50	8.94	8	0.75	4.72	5.43
125	5.00	8.50	9.92	8	0.87	5.71	6.54
150	5.91	9.51	10.91	8	0.87	6.61	7.48
200	7.80	11.75	13.43	8	0.87	8.50	9.72
250	9.80	14.25	15.91	12	0.98	10.63	12.05
300	11.81	17.01	18.94	12	0.98	12.76	13.86
350	13.78	18.74	20.91	12	1.14	14.57	15.35

For Waterworks

■ Dimensions Table

(Unit: mm)

Size	D ₁	D ₂	D ₃	n	e	d ₁	d ₂	t
40	43	105	138	4	19	54	69	3
50	53	120	153	4	19	69	85	3
75 (80)	80	168	209	4	19	98	114	3
100	102	195	236	4	19	120	138	3
125	127	220	261	6	19	145	164	3

Size	D ₁	D ₂	D ₃	n	e	d ₁	d ₂	t
150	152	247	288	6	19	171	190	3
200	202	299	340	8	19	216	240	3
250	253	360	408	8	23	273	300	3
300	303	414	461	10	23	325	352	3
350	353	472	527	10	25	375	405	3

- Notes: 1. 40mm(1 1/2inch) is out of waterworks specification (JIS 10K Standard Products)
 2. Rubber used for AV gasket is accordance with tap water rubber(JIS K 6353)
 (SBR: Styrene-Butadiene Rubber)

Inner-Face Gasket

PRODUCT MODEL CODE	JIS 10K	G	N	Rubber Type	1	Size
	JIS 5K	G	N	Rubber Type	5	Size
	Waterworks (SBR)	G	A	Rubber Type	W	Size

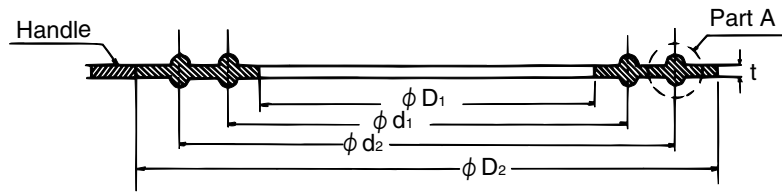

Detail of part A

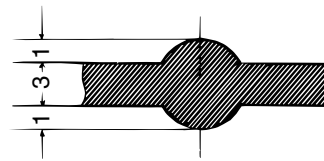

For JIS 10K, 5K Material: EPDM

Dimensions Table

(Unit: mm)

Size	Standard	D_2	D_1	d_1	d_2	t
15	5K	47	18	26	39	3
	10K	54		26	41	
20	5K	52	22	30	44	3
	10K	59		32	47	
25	5K	62	30	39	53	3
	10K	70		38	53	
32	5K	74	37	45	60	3
	10K	80		50	65	
40	5K	79	43	53	69	3
	10K	85		54	69	
50	5K	89	54	64	79	3
	10K	100		68	83	
65	5K	114	69	82	101	3
	10K	120		86	101	
80	5K	125	80	93	112	3
	10K	130		98	112	
100	5K	145	102	114	133	3
	10K	155		120	138	
125	5K	180	127	142	165	3
	10K	187		145	166	
150	5K	210	150	167	193	3
	10K	217		168	190	
200	5K	257	198	215	240	3
	10K	267		216	247	
250	5K	322	249	270	301	3
	10K	329		270	306	
300	5K	367	300	318	349	3
	10K	374		324	352	

For Waterworks Material: SBR

Dimensions Table

(Unit: mm)

Size	D_2	D_1	d_2	d_1	t
40	85	43	69	54	3
50	100	53	83	68	3
75 (80)	148	80	110	90	3
100	175	102	135	115	3
125	200	127	160	140	3
150	227	152	187	168	3
200	279	202	236	218	3
250	337	253	288	270	3
300	391	303	340	320	3
350	445	353	400	370	3

- Notes: 1.40 mm (11/2 inch) is out of waterworks specification. (JIS 10K Standard Product)
 2. Rubber used for AV gasket is accordance with tap water rubber (JIS K 6353).
 (SBR: Styrene-Butadiene Rubber)

AV PTFE/PVDF Gasket

PRODUCT MODEL CODE	PTFE	G	A	T	Standard	Size
	PVDF	G	A	F	Standard	Size



* PTFE covering thickness is 0.3 – 0.4 mm.



* PVDF covering thickness is
15 mm (1/2 inch) – 65 mm (2 1/2 inch).....0.4 mm
80 mm(3 inch) – 300 mm (12 inch).....0.5 mm

PTFE-Covering

PVDF-Covering

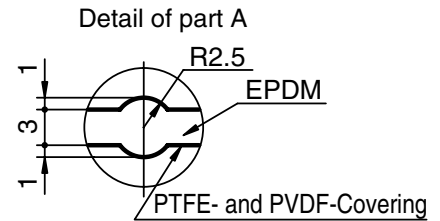
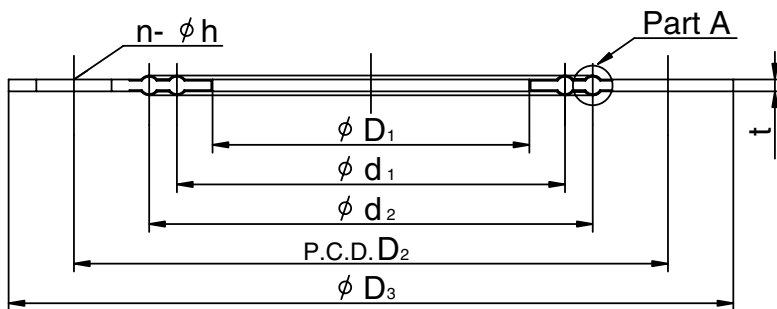

For JIS 10K

Dimensions Table

(Unit: mm)

Size	D ₁ (Inner Diameter)	D ₂ (P.C.D)	D ₃ (Outer Diameter)	n	e	d ₁	d ₂	t
15	18	70	93	4	15	26	41	3
20	22	75	98	4	15	32	47	3
25	30	90	123	4	19	38	53	3
32	37	100	133	4	19	50	65	3
40	43	105	138	4	19	54	69	3
50	54	120	153	4	19	68	83	3
65	69	140	173	4	19	86	101	3
80	80	150	183	8	19	98	112	3
100	102	175	208	8	19	120	138	3
125	127	210	248	8	23	145	166	3
150	150	240	278	8	23	168	190	3
200	198	290	328	12	23	216	247	3
250	249	355	398	12	25	270	306	3
300	300	400	443	16	25	324	352	3

For DIN PN10

Dimensions Table

(Unit: mm)

Size	D ₁	D ₂	D ₃	n	e	d ₁	d ₂
15	18	65	93	4	14	26	41
20	22	75	103	4	14	32	47
25	30	85	113	4	14	38	53
32	37	100	138	4	18	50	65
40	43	110	148	4	18	54	69
50	54	125	163	4	18	68	83
65	69	145	183	4	18	86	101
80	80	160	198	8	18	98	112
100	102	180	218	8	18	120	138
125	127	210	248	8	18	145	166
150	150	240	283	8	22	168	190
200	198	295	338	8	22	216	247
250	249	350	393	12	22	270	306
300	300	400	443	12	22	324	352
350	362	460	503	16	22	387	413
400	407	515	563	16	26	442	472

For ANSI Class 150

Dimensions Table

(Unit: inch)

Size (mm)	D ₁	D ₂	D ₃	n	e	d ₁	d ₂
15	0.71	2.38	3.43	4	0.63	1.02	1.61
20	0.87	2.76	3.78	4	0.63	1.26	1.85
25	1.18	3.13	4.17	4	0.63	1.50	2.09
30	1.46	3.50	4.53	4	0.63	1.97	2.56
40	1.69	3.88	4.92	4	0.63	2.13	2.72
50	2.13	4.74	5.91	4	0.75	2.68	3.27
65	2.72	5.49	6.93	4	0.75	3.39	3.98
80	3.15	6.00	7.44	4	0.75	3.86	4.41
100	4.02	7.50	8.94	8	0.75	4.72	5.43
125	5.00	8.50	9.92	8	0.87	5.71	6.54
150	5.91	9.51	10.91	8	0.87	6.61	7.48
200	7.80	11.75	13.43	8	0.87	8.50	9.72
250	9.80	14.25	15.91	12	0.98	10.63	12.05
300	11.81	17.01	18.94	12	0.98	12.76	13.86

Notes: Sizes of 1-1/4" (30 mm), 2-1/2" (65 mm) and 12" (300 mm) for ANSI Standard PVDF-covering gasket cannot be manufactured.

Viflon®

PRODUCT MODEL CODE

Viflon®F/FKM-F ▶ G A 1 1 Size

Viflon®C/FKM-C ▶ G A 2 1 Size

- Excellent elution characteristic for TOC, metal ions, etc.
- Better cost performance compared to perfluoro fluorine rubber.

Viflon®F/FKM-F (For Acid-Resistant)

Effective for nitric acid, hydrofluoric acid, hydrochloric acid, etc., especially works well with mixed acid such as nitric hydrofluoric acid.

Viflon®C/FKM-C (For Chlorine-Resistant)

Effective for chlorine-type chemicals, especially sodium hypochlorite injection lines, and excellent chemical-resistance compared to conventional fluorine-based rubber.

Viflon®Full Face Gasket

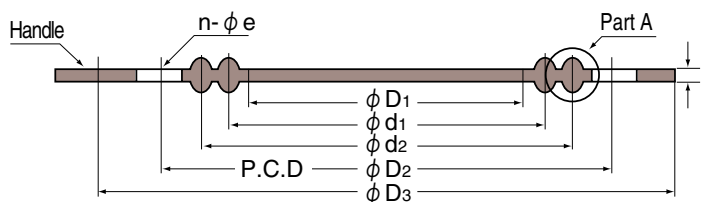

Dimensions in parenthesis show the case of 350 mm (14 inch).

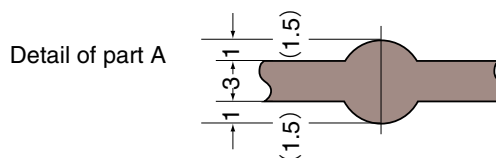

Viflon®F/FKM-F Gasket...For Acid-Resistant Type

Viflon®C/FKM-C Gasket...For Chlorine-Resistant Type

■ Dimensions Table

(Unit: mm)

Size	Full Face JIS 10K							
	D ₃	D ₂	D ₁	d ₂	d ₁	n	e	t
15	93	70	18	41	26	4	15	3
20	98	75	22	47	32	4	15	3
25	123	90	30	53	38	4	19	3
32	133	100	37	65	50	4	19	3
40	138	105	43	69	54	4	19	3
50	153	120	54	83	68	4	19	3
65	173	140	69	101	86	4	19	3
80	183	150	80	112	98	8	19	3
100	208	175	102	138	120	8	19	3
125	248	210	127	166	145	8	23	3
150	278	240	150	190	168	8	23	3
200	328	290	198	247	216	12	23	3

PRODUCT MODEL CODE LIST

■ Bellmouth

Type	Field	Model	Material	Standard	Size
F	N	R	*	*	***
⋮	⋮	⋮	⋮	⋮	⋮
F Bellmouth	N None Color	R Bellmouth	U U-PVC I HI-PVC	1 JIS 10K W Waterworks	040 40mm I 350 350mm

AV Bellmouth



U-PVC



HI-PVC

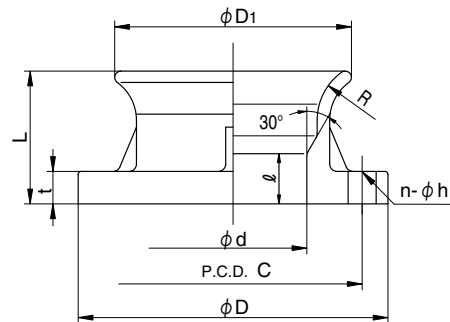

■ Dimensions Table

(Unit: mm)

Size	JIS10K				JIS B 2062 Waterworks				t	d	D ₁	L	R	ℓ
	D	C	n	h	D	C	n	h						
40	—	—	—	—	140	105	4	19	16	41	75	55	18	13
50	—	—	—	—	155	120	4	19	20	50	90	65	25	22
80 (75)	185	150	8	19	211	168	4	19	22	78	130	80	33	30
100	210	175	8	19	238	195	4	19	24	100	160	90	40	34
125	250	210	8	23	263	220	6	19	24	125	190	95	45	34
150	280	240	8	23	290	247	6	19	24	148	230	106	52	38
200	330	290	12	23	342	299	8	19	28	196	300	125	70	4
250	400	355	12	25	410	360	8	23	30	247	360	145	90	4
300	445	400	16	25	464	414	10	23	30	298	415	145	100	4
350	490	445	16	25	—	—	—	—	34	348	480	190	120	4

Notes: HI-PVC is available for 80 to 200 mm with JIS10K and 40 to 200 mm for waterworks.

PRODUCT MODEL CODE LIST

Type	Material	Model	Standard	Type	Size
LK	R	**	J	*	***
⋮	⋮	⋮	⋮	⋮	⋮
LK Opening/Closing Base	R FRP	1P FR-1 P Type 1S FR-1 S Type	J JIS	J Left-Opening Spindle SUS G Right-Opening Spindle SUS	050 50mm I 350 350mm

FRP Opening/Closing Base

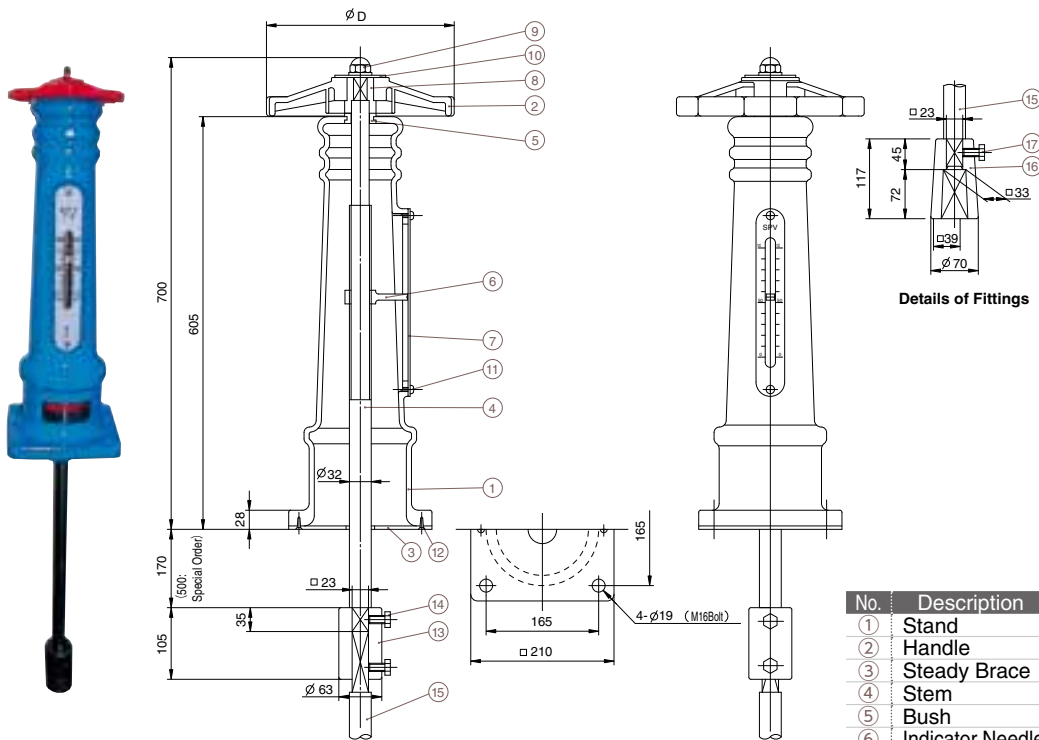

- Notes:
- 1) Transparent
 - 2) Up to size 150 mm
 - 3) Tar-epoxy resin paint when the material is FC200

No.	Description	Pcs.	Material
①	Stand	1	FRP
②	Handle	1	PP
③	Steady Brace	1	FRP
④	Stem	1	SUS403
⑤	Bush	1	BC6
⑥	Indicator Needle	1	BC6
⑦	Scale Plate	1	PVC ¹⁾
⑧	Handle Bush	1	AC4C
⑨	Cap Nut	1	SUS304
⑩	Washer	1	U-PVC ²⁾
⑪	Scale Plate Installation Screw	2	C3064
⑫	Steady Brace Installation Screw	2	SUS304
⑬	Middle Joint	1	FC200 (Standard Product) ³⁾
⑭	Hexagonal Bolt (A)	2	SUS304
⑮	Middle Rod	1	SUS403 (Standard Product)
⑯	Fitting	1	FC200 (Standard Product) ³⁾
⑰	Hexagonal Bolt	1	SUS304

■ Dimensions Table

(Unit: mm)

Size	40	50	80 (75)	100	125	150	200	250	300	350
Handle Diameter D	195	195	195	195	270	270	360	360	455	455

Notes: A higher version made with handle diameter can be installed on request.

PRODUCT MODEL CODE LIST

■ Type I

Type	Material	Type	Standard	Connection	Size
LG	*	G1	1	**	***
⋮	⋮	⋮	⋮	⋮	⋮
LG Gauge Flange	U U-PVC C C-PVC F PVDF	G1 Type I	1 JIS 10K	A 15mm B 20mm C 25mm	020 20mm I 300 300mm

■ Type II

Type	Material	Type	Standard	Gauge Connection Side	Size
LG	*	G2	1	N	***
⋮	⋮	⋮	⋮	⋮	⋮
LG Gauge Flange	U U-PVC C C-PVC F PVDF	G2 Type II	1 JIS	N Threaded	020 20mm I 300 300mm

■ Type III

Type	Material	Type	Standard	Gauge Connection Side	Size	Size
LG	*	G3	1	S	***	*
⋮	⋮	⋮	⋮	⋮	⋮	⋮
LG Gauge Flange	U U-PVC C C-PVC F PVDF	G3 Type III	1 JIS	S Standard	075 75mm I 250 250mm	E Rc1/2 F Rc3/4

Gauge Flange



Material	Fluid Temperature	Working Pressure (Normal Temperature)	Connection Method
Unplasticized Polyvinyl Chloride Pipe (U-PVC)	0 - 50°C	1.0MPa {10.2kg/cm ² }	Wafer (JIS 10K)
Heat-Resistant Polyvinyl Chloride (C-PVC)	0 - 80°C	1.0MPa {10.2kg/cm ² }	Wafer (JIS 10K)
Polyvinylidene Fluoride (PVDF)	-20 - 100°C	1.0MPa {10.2kg/cm ² }	Wafer (JIS 10K)

Type : I

■ Dimensions Table

(Unit: mm)

Size	L	O.D	R	P.C.D	φD	N-φE
20	160	100	50	75	22	4-15
25	170	125	62.5	90	25	4-19
32	175	135	67.5	100	30	4-19
40	178	140	70	105	41	4-19
50	185	155	77.5	120	52	4-19
65	195	175	87.5	140	67	4-19
80 (75)	200	185	92.5	150	78	8-19
100	215	210	105	175	100	8-19
125	232	250	125	210	125	8-23
150	250	280	140	240	146	8-23
200	273	330	165	290	196	12-23
250	310	400	200	355	247	12-25
300	335	445	222.5	400	298	16-25

Features

- Excellent corrosion-resistance and chemical-resistance.
- The wafer shape gives strength and compact piping is feasible.
- Maintenance of a detection path is easy with the attached plug.
- Attaching a cock makes a solution sampling port.
- Lightweight and installation is easy.
- Cost can be reduced from the conventional type.

Type : I In the case of JIS10K 20 mm×20 mm – 300 mm

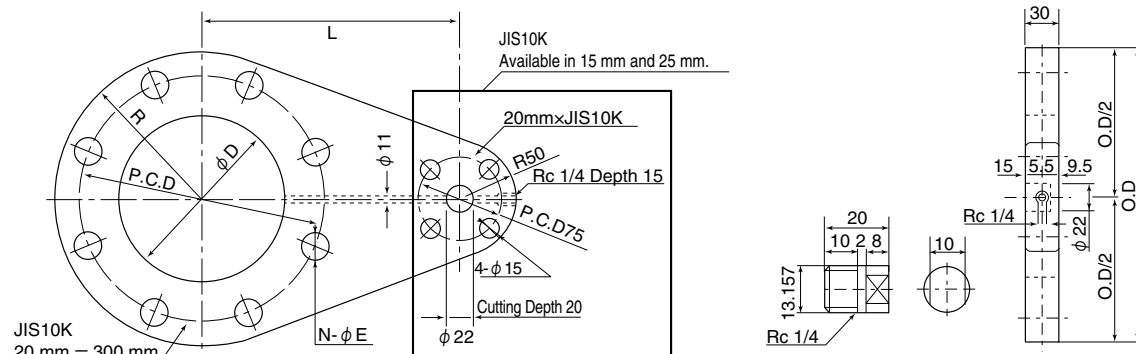

AV Gauge Flange

Type : II

JIS10K 20 – 300 mm

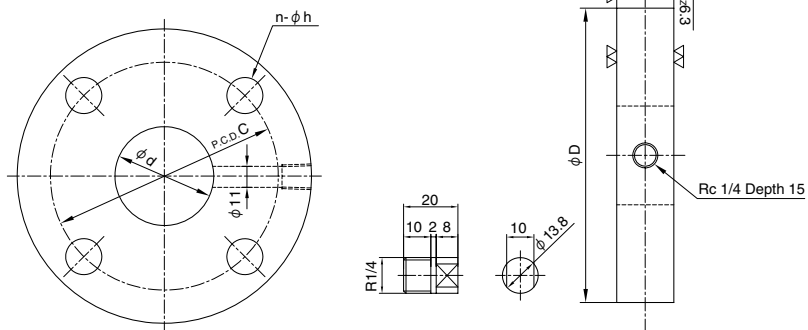

Type: III

JIS10K 75 – 250 mm

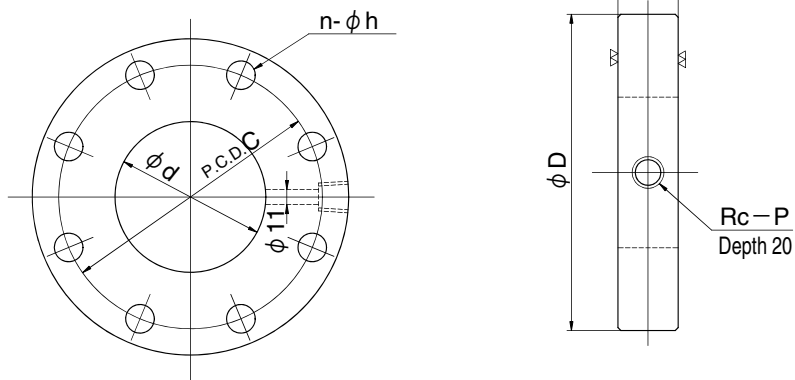

Type : II

Dimensions Table

(Unit: mm)

Size	d	JIS 10K			
		D	C	n	h
20	22	100	75	4	15
25	25	125	90	4	19
30	30	135	100	4	19
40	41	140	105	4	19
50	52	155	120	4	19
65	67	175	140	4	19
80	78	185	150	8	19
100	100	210	175	8	19
125	125	250	210	8	23
150	146	280	240	8	23
200	196	330	290	12	23
250	247	400	355	12	25
300	298	445	400	16	25

Type : III

Dimensions Table (Unit: mm)

Size	d	D	C	n	h	t		P	
						In the case of Rc1/2	In the case of Rc1/4	1/2	3/4
75	78	185	150	8	19	40 ^{+2.8}	45 ^{+4.5} ₀	1/2	3/4
100	100	210	175	8	19	40 ^{+2.8}	45 ^{+4.5} ₀	1/2	3/4
150	146	280	240	8	23	40 ^{+2.8}	45 ^{+4.5} ₀	1/2	3/4
200	196	330	290	12	23	40 ^{+2.8}	45 ^{+4.5} ₀	1/2	3/4
250	247	400	355	12	23	40 ^{+2.8}	45 ^{+4.5} ₀	1/2	3/4

Application Example



PRODUCT MODEL CODE LIST

Type	Material	Case Size	Standard	Connection	Scale
LPG	U	*	*	**	**
⋮	⋮	⋮	⋮	⋮	⋮
LPG Diaphragm Type Pressure Gauge	U PVC	A $\phi 75$ B $\phi 100$	1 JIS 10K 5 JIS 5K 3 G 3/8 8 R 3/8 2 G 1/2 4 R 1/2	15 15mm 20 20mm 25 25mm	01 0.1MPa 16 0.16MPa 02 0.2MPa 25 0.25MPa 03 0.3MPa to 10 1.0MPa

AV Diaphragm Type Pressure Gauge



Flanged

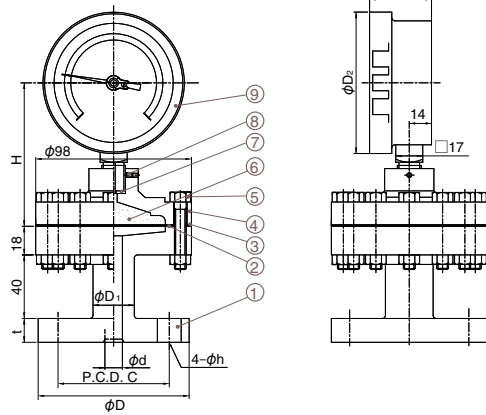

JIS: Threaded End

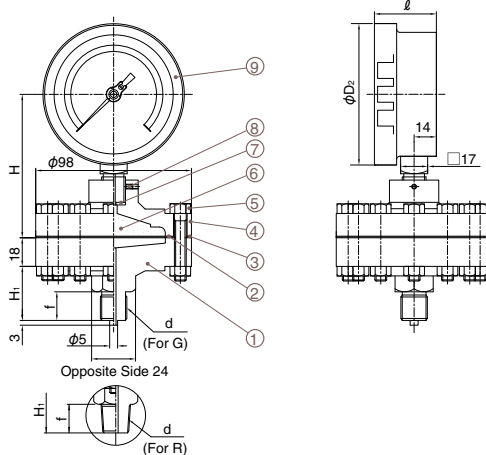

<Use Precautions>

Because diaphragm type pressure gauge contains pressurizing liquid in the upper flange and Bourdon tube, never loosen the tightening bolts of upper/lower flanges and the indicator's threaded part. Pressurize gradually. Avoid abrupt opening of valves, especially, and pressurize quietly. Read indicated pressure from the deflection width of the needle of indicator.

Features

Because PTFE diaphragm is used for the pressure-receiving part and the Bourdon tube is filled with a food antifreezing solution and disconnected from the indicator by the diaphragm, the pressure of fluid can be measured without going through the Bourdon tube. There are 2 types for installation of diaphragm type pressure gauge, threaded and flanged.

Dimensions Table (Flanged)

(Unit: mm)

Pressure Gauge Case Size	Size	d	JIS 10K			t	D ₁	D ₂	H	ℓ
			D	C	h					
φ 75	15	13	95	70	15	20	33	89	90	39
	20	15	100	75	15	22	35	89	90	39
	25	20	125	90	19	22	40	89	90	39
φ 100	15	13	95	70	15	20	26	114	104	40
	20	15	100	75	15	22	30	114	104	40
	25	20	125	90	19	22	35	114	104	40

Dimensions Table (JIS: Threaded End)

(Unit: mm)

Pressure Gauge Case Size	d	f	D ₂	H	H ₁	ℓ
φ 75	G3/8	18	89	90	34	39
	R3/8	18	89	90	34	39
	G1/2	20	89	90	36	39
	R1/2	20	89	90	36	39
φ 100	G3/8	18	114	104	34	40
	R3/8	18	114	104	34	40
	G1/2	20	114	104	36	40
	R1/2	20	114	104	36	40

Specification

Pressure Gauge Case Size	JIS 10k Flanged	JIS Threaded End	Pressure Gauge Maximum Scale
φ 75	15 mm	G3/8 R3/8	0.1MPa
	20 mm		0.16MPa
	25 mm		0.2MPa 0.25MPa 0.3MPa
φ 100	15 mm	G3/8 R3/8 G1/2 R1/2	0.4MPa
	20 mm		0.5MPa
	25 mm		0.6MPa
			0.7MPa 1.0MPa

No.	Description	Pcs.	Material
①	Lower Flange	1	PVC
②	Gasket	1	PTFE
③	Diaphragm	1	PTFE
④	Upper Flange	1	PVC
⑤	Bolt & Nut	12	SUS304
⑥	Seal Liquid		Food Additive Glycerin
⑦	Gasket	1	PTFE
⑧	Pressure Gauge Thread	1	SUS304
⑨	Pressure Gauge	1	ABS and others

PRODUCT MODEL CODE LIST

Type	Model	Material	Size	Length	Standard
M	B	*	***	***	A
M Maintenance Material	B Bolt	U U-PVC F PVDF	008 M8 010 M10 012 M12 016 M16 020 M20	020 20L 055 55L 014 14L 065 65L 025 25L 070 70L	A Full Thread

Bolt/Nut/Washer

PRODUCT MODEL CODE	Normal Thread	M	B	U	Size	Length
	Full Thread	M	B	U	Size	Length
	Nut	M	N	U	Size	
	Washer	M	W	U	Size	



Features

- Excellent corrosion-resistance as unplasticized polyvinyl chloride bolt and nut are casted together.

Main Specification

Material	Size	Working Temperature Range	Product Lineup		
			Bolt	Bolt	Nut
Unplasticized Polyvinyl Chloride Pipe (U-PVC)	M8, M10, M12, M16, M20	-10 - 35°C	○	○	○

Dimensions Diagram

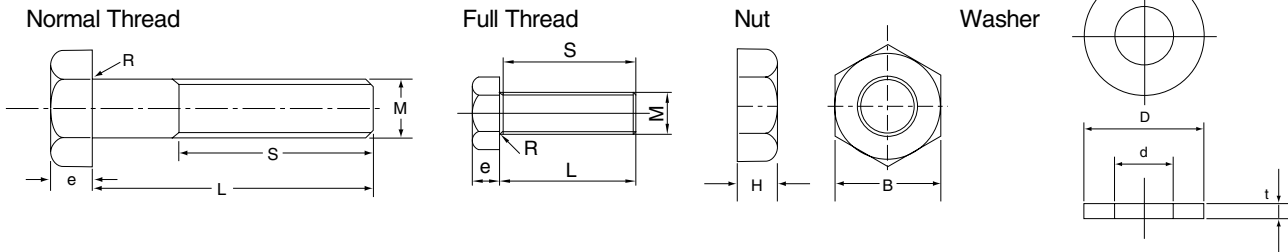

Dimensions Table

(Unit: mm)

M8		M10		M12		M16		M20		M8		M10		M12		M16		M20					
L	S	L	S	L	S	L	S	L	S	L	S	L	S	L	S	L	S	L	S				
Standard	Full Thread	Standard	Full Thread	Standard	Full Thread	Standard	Full Thread	Standard	Full Thread	Standard	Full Thread	Standard	Full Thread	Standard	Full Thread	Standard	Full Thread	Standard	Full Thread				
20	18	14	12	25	23	40	38	55	46	-	-	40	26	38	60	30	-	75	38	-	-	-	-
25	23	20	18	30	28	45	38	43	65	46	-	-	45	26	43	65	30	-	80	38	-	-	-
32	22	30	25	36	34	50	38	48	75	46	-	-	50	26	48	70	30	-	85	38	-	-	-
38	22	36	28	40	38	55	38	-	80	46	-	-	55	26	-	-	-	-	95	38	-	-	-
50	22	48	30	28	45	43	60	38	-	85	46	-	-	60	26	-	-	-	-	-	-	-	-
55	22	53	32	26	30	50	30	48	65	38	-	90	46	-	-	-	-	-	-	-	-	-	-
-	-	-	36	26	34	56	30	-	70	38	-	-	-	-	-	-	-	-	-	-	-	-	-

(Unit: mm)

Thread Nominal M	Pitch	B	H	e	R	D	d	t
M 8	1.25	13	6.5	5.5	0.2	18.2	8.4	2
M10	1.5	17	8	7	0.2	22.0	10.5	2
M12	1.75	19	10	8	0.3	26.0	13.5	3
M16	2.0	24	13	10	0.4	32.0	17.0	3
M20	2.5	30	16	13	0.4	40.0	21.0	3

<Use Precautions>

Use in combination of AV bolt, nut and washer is recommended.
Engagement may differ if a combination other than AV bolt and nut is used.
Do not use in combination with metal bolt and nut.

PRODUCT MODEL CODE LIST

Type	Model	Material	Size
M	N	*	***
⋮	⋮	⋮	⋮
M Maintenance Material	N Nut	U U-PVC F PVDF	008 M8 010 M10 012 M12 016 M16 020 M20

PVDF is only available in M8, M10 and M12.

Type	Model	Material	Size
M	W	U	***
⋮	⋮	⋮	⋮
M Maintenance Material	W Washer	U U-PVC	008 M8 010 M10 012 M12 016 M16 020 M20

Bolt&Nut

PRODUCT MODEL CODE	Normal Thread	M	B	F	Size	Length	
	Full Thread	M	B	F	Size	Length	A
	Nut	M	N	F	Size		



Features

- Excellent chemical-resistance against strong acid/organic solvents or halogens such as chlorine and bromine for which conventional metals or U-PVC bolts and nuts could not use.
- Impact strength is 3 to 4 times of U-PVC as made of PVDF.
- Non-toxic and odorless bolts and nuts passed the test under the Food Sanitation Act.

Main Specification

Material	Working Temperature Range	Product Lineup	
		Bolt	Nut
Polyvinylidene Fluoride (PVDF)	-40 - 90°C	○	○

Dimensions Diagram

Normal Thread

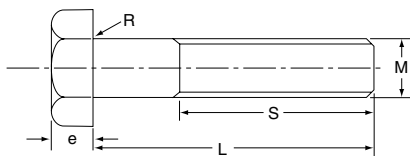

Full Thread

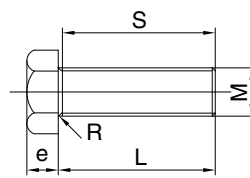

Nut

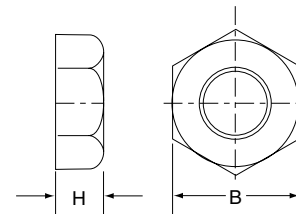

Dimensions Table

(Unit: mm)

M8			M10			M12			M8			M10			M12		
L	S		L	S		L	S		L	S		L	S		L	S	
	Standard	Full Thread		Standard	Full Thread		Standard	Full Thread		Standard	Full Thread		Standard	Full Thread		Standard	Full Thread
20	18		14	12		25	23		-	-		40	26	38	60	30	-
25	23		20	18		30	28		-	-		45	26	43	65	30	-
32	22	30	25	23	36	34	-	-		50	26	48	70	30	-	-	
38	22	36	28	26	40	38	-	-		55	26	-	-	-	-	-	
50	22	48	30	28	45	43	-	-		60	26	-	-	-	-	-	
55	22	53	32	26	30	50	30	48	-	-		65	26	-	-	-	-
-	-	-	36	26	34	56	30	-	-	-		-	-	-	-	-	-

(Unit: mm)

Thread Nominal M	Pitch	B	H	e	R	D	d	t
M 8	1.25	13	6.5	5.5	0.2	18.2	8.4	2
M10	1.5	17	8	7	0.2	22.0	10.5	2
M12	1.75	19	10	8	0.3	26.0	13.5	3
M16	2.0	24	13	10	0.4	32.0	17.0	3
M20	2.5	30	16	13	0.4	40.0	21.0	3

<Use Precautions>

Engagement may differ if a combination other than AV bolt and nut is used.
Do not use in combination with metal bolt and nut.

PRODUCT MODEL CODE LIST

Type	Model	Material	Size
M	S	U	***
⋮	⋮	⋮	⋮
M Maintenance Material	S Saddle	U U-PVC	016 16mm 200 200mm

Saddle



U-PVC

Features

- Corrosion-resistance as made of unplasticized polyvinyl chloride and no electric corrosion.
- Safe to use with increased strength by retaining sufficient wall thickness.

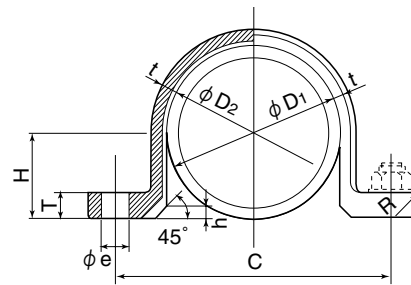
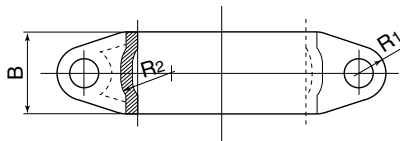

Dimensions Table

(Unit: mm)







Size	D ₁	D ₂	C	R ₁	H	T	t	B	e	R ₂	h	Bolt in Use
16	22	24	42	5.5	11	5	3	15	5.8	11	2.5	M 5
20	26	29	48	5.5	13	5	3	18	5.8	13	2.5	M 5
25	32	35	54	5.5	16	6	3	18	5.8	13	2.5	M 5
30	38	41	66	7	19	7	3.5	20	7	15	3	M 6
40	48	52	90	9.5	24	9	4	24	10	17	3.5	M 8
50	60	64	97	9.5	30	9	4	28	10	18.5	4	M 8
65	76	81	114	9.5	38	10	4	30	10	18	4.5	M 8
75	89	94	134	12	44.5	11	4	38	12	28	4.5	M10
100	114	120	160	12	57	12	4.5	42	12	30	5	M10
125	140	150	192	15	70	12	5	46	12	31	5	M10
150	165	177	238	16	82.5	14	8	50	17	34	5	M14
200	216	236	316	18	108	20	10	70	19	36	8	M16

PRODUCT MODEL CODE LIST

Type	Model	Brush	Weight
C	*	*	***
⋮	⋮	⋮	⋮
C AV Cement	3 AV Cement 32	1 With brush	001 100g
	5 AV Cement 52	0 Without brush	003 250g
	6 AV Cement 62		005 500g
	8 AV Cement 88		010 1kg
	9 AV Cement 90		
	1 AV Cement 100		
	2 AV Cement 102		

AV Cement

Adhesives in the following table are available depending on types of pipes & fittings.

	AV Cement 32	AV Cement 52	AV Cement 62	AV Cement 88	AV Cement 90	AV Cement 100	AV Cement 102
							
	Japan Water Works Association (JWWA-S101)	Japan Water Works Association (JWWA-S101)			Japan Water Works Association (JWWA-S101)	Japan Water Works Association (JWWA-S101)	
Classification	Low Viscosity Quick Dry	High Viscosity Quick Dry	High Viscosity Slow Dry	Low Viscosity Quick Dry	Low Viscosity Quick Dry	Low Viscosity Quick Dry	High Viscosity Slow Dry
Adhesive Color	Transparent	Transparent	Transparent	Transparent	Transparent	White	White
Applicable Pipe Type	① General Pipe (VP, VU)	○	○	○	○	○	○
	① High Purity Resistance Polyvinyl Chloride Pipe (HP-PVC)	○	○	○	○	○	○
	② HI Pipe	×	×	×	○	○	○
	③ C-PVC Pipe	×	×	×	○	×	×
Packaging	100g · 500g · 1kg can with brush	500g can with brush	1kg can with brush	250g · 500g can with brush	500g · 1kg can with brush	1kg can with brush	1kg can without brush (wide mouth)
Container Color	Blue	Red	Yellow	Brown	Dark Blue	Light Blue	Dark Green

Notes: 1. ○ is recommended, × is not usable. 2. ○ is usable.

3. Select an adhesive with higher resolution (higher number circled in the table above) when connecting different materials.

Resolution **C-PVC** > **HI-PVC** > **U-PVC**

(Example: In the case of connecting C-PVC Pipe and High Purity Pipe...Use AV Cement 88)

4. Products marked as "Japan Water Works Association (JWWA S101)" in the table above are accordance with materials, manufacturing methods and compositions specified in the "JWWA S101 Tap Water Hard Polyvinyl Chloride Pipe Adhesive", and its quality has been confirmed by passing our standard testing.

AV Cement

AV Cement Standard Table

Product Name	Classification	Symbol	Container Color	Viscosity (CP)	Loss on Drying (%)	Bonding Power (MPa)	
						After 15 minutes	After 2 hours
AV Cement 32	Low Viscosity Quick Dry	A	Blue	100 – 250	30 – 50	1.25 or more	2.5 or more
AV Cement 52	High Viscosity Quick Dry	B	Red	800 – 1500	30 – 50	1.25 or more	2.5 or more
AV Cement 62	High Viscosity Slow Dry	—	Yellow	500 – 1500	10 – 30	—	1.5 or more
AV Cement 88	Low Viscosity Quick Dry	—	Brown	200 – 700	—	1.25 or more	2.5 or more
AV Cement 90	Low Viscosity Quick Dry	A	Dark Blue	500 – 800	30 – 50	1.25 or more	2.5 or more
AV Cement 100 (White)	Low Viscosity Quick Dry	A	Light Blue	500 – 800	30 – 50	1.25 or more	2.5 or more
AV Cement 102 (White)	High Viscosity Slow Dry	—	Dark Green	400 – 1000	10 – 30	—	1.5 or more

⚠ <Use Precautions>

* AV cement is applicable to Class 1 petroleum, Class 4 hazardous materials of Article 2 of the Fire Services Act. Be cautious of storage.
* Read "Use Precautions" stipulated on the can carefully and follow the instructions when using.

Relationship Between Leave Time and Bonding Strength in the Case of Using AV Cement for TS Fitting Maximum pulling load with the size of 13 mm at 20°C Bonding power inside ()

Product Name	1 minute	3 minutes	5 minutes	10 minutes	15 minutes	30 minutes	1 hour	2 hours	3 hours	6 hours	12 hours	24 hours
⊙ AV Cement 32	540 (0.4)	1,320 (1.0)	1,570 (1.2)	2,010 (1.5)	2,260 (1.7)	2,840 (2.1)	3,330 (2.5)	3,730 (2.7)	4,020 (2.9)	4,560 (3.3)	Cracked	—
⊙ AV Cement 52	1,260 (0.9)	1,770 (1.3)	2,160 (1.6)	2,510 (1.9)	2,790 (2.1)	3,330 (2.5)	3,730 (2.7)	4,120 (3.0)	4,360 (3.2)	4,810 (3.5)	Cracked	—
⊙ AV Cement 62	—	—	—	410 (0.3)	800 (0.6)	1,320 (1.0)	2,150 (1.6)	2,750 (2.1)	3,040 (2.3)	3,880 (2.8)	4,460 (3.3)	Cracked
⊙ AV Cement 88	—	—	—	—	1,670 (2.3)	2,260 (2.8)	3,040 (3.6)	3,240 (4.2)	3,630 (4.7)	4,410 (5.7)	5,300 (6.9)	6,180 (8.2)

Standard Table of Adhesive Necessary for TS Fitting Connection

Size (mm)	13	16	20	25	30	40	50	65	75	100	125	150	200	250	300	350	400	450	500
Application Amount (g/location)	0.9	1.2	1.7	2.0	3.1	5.0	7.1	9.9	12	20	30	44	59	78	104	244	318	400	490

Applicable Adhesive: ⊙ AV Cement 32 or ⊙ AV Cement 52 or ⊙ AV Cement 90 or ⊙ AV Cement 100 (White) ⊙ AV Cement 62 or ⊙ AV Cement 102 (White)

Notes: Applicable adhesives above are described from how quick or slow to dry by type and this will not be applied depending on the work environmental conditions.

PRODUCT MODEL CODE LIST

Type	Model	Material Use	Weight
Q	0	0	010
⋮	⋮	⋮	⋮
Q Lubricant	0 Lubricant	0 Lubricant	010 100g

AV Lubricant



Net Weight: 1 kg

Use AV lubricant for rubber ring connection. Do not use other soap water, grease, etc.

Normal application amount per rubber ring connection

Size (mm)	50	75	100	125	150	200	250	300	350	400	450	500
Application Amount (g)	4	5	10	15	20	25	35	50	65	90	115	140

Notes: Read "Use Precautions" stipulated on the product carefully when using.

PRODUCT MODEL CODE LIST

Type	Material	Material	Color	Size	Overall Length
PD	U	**	VN	***	04T
PD Air-Conditioning Drain Pipe	U U-PVC	PP VP UP VU	VN Standard	016 16mm 040 40mm	04T 4m

Type	Material	Type	Color	Size
TD	U	**	JN	***
TD Air-Conditioning Drain Fitting BD Air-Conditioning Drain Bend	U U-PVC	9L 90° Elbow 4L 45° Elbow 45 Bend TE Tee SO Socket	JN Standard VN 45 Bend	016 16mm 040 40mm 020016 25x20mm 040030 40x30mm

Type	Material	Color	Size
LSB	U	*	***
LSB Saddle Band	U U-PVC	D Ivory White G Gray	016 16mm 040 40mm

Air-Conditioning Drain Pipe & Fittings, Saddle



Features

- Lightweight and easy installation as made of unplasticized polyvinyl chloride.
- Use of high-grade pigments gives bright colors and brings harmony to construction facilities.
- VP pipes of 16 to 40 mm and VU pipes of 20 and 25 mm as well as a variety of fittings and saddle bands are available.

Color	Munsell	Reference
Value Ivory White	5Y 9/07 (Standard Color)	

Dimensions Table

(Unit: mm)

Size	Product Number	VP					VU				
		Approximate Inner Diameter	Outer Diameter	Length	Wall Thickness	Cardboard Packaging (pcs.)	Approximate Inner Diameter	Outer Diameter	Length	Wall Thickness	Cardboard Packaging (pcs.)
16	AVP16	16	22	4000	3.0	20	-	-	-	-	-
20	AVP20	20	26	4000	3.0	15	22	26	4,000	2.0	15
25	AVP25	25	32	4000	3.5	12	26.8	32	4,000	2.6	12
30	AVP30	31	38	4000	3.5	9	-	-	-	-	-
40	AVP40	40	48	4000	4.0	6	-	-	-	-	-

* Accordance with JIS K6741.

90° Elbow

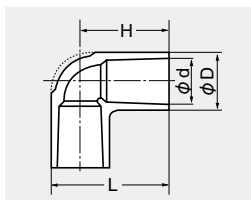

Dimensions Table

(Unit: mm)

Size	Product Number	φ d	φ D	H	L	Package (pcs.)
16	AV90L16	22.40	29	43	57.5	100/400
20	AV90L20	26.45	33	50	66.5	60/240
25	AV90L25	32.55	40	58	78	35/140
30	AV90L30	38.60	46	65	88	25/100
40	AV90L40	48.70	57	82	110.5	30/60

45° Elbow

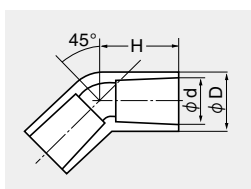

Dimensions Table

(Unit: mm)

Size	Product Number	φ d	φ D	H	Package (pcs.)
20	AV45L20	26.45	33	44	65/260
25	AV45L25	32.55	40	51	40/160
▲ 30	AV45L30	38.60	46	56	30/120
40	AV45B40	48.70	57	69	36/36

▲ are stock products. * 40 mm is nominal bend.

Air-Conditioning Drain Pipe & Fittings, Saddle

Tee

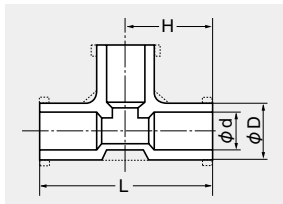

■ Dimensions Table

(Unit: mm)

Size	Product Number	φd	φD	H	L	Package (pcs.)
16	AVT16	22.40	29	43	86	60/240
20	AVT20	26.45	33	50	100	40/160
25	AVT25	32.55	40	58	116	20/80
30	AVT30	38.60	46	65	130	15/60
40	AVT40	48.70	57	82	164	15/30

Reducing Tee

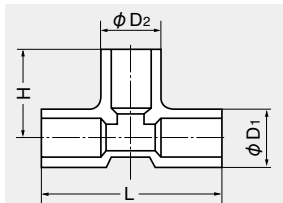

■ Dimensions Table

(Unit: mm)

Size	Product Number	φD ₁	φD ₂	H	L	Package (pcs.)
25×20	AVT25×20	40	33	53	110	25/100
30×25	AVT30×25	46	40	61	124	18/72
40×25	AVT40×25	57	40	67	146	23/46
40×30	AVT40×30	57	46	71	152	23/46

Socket

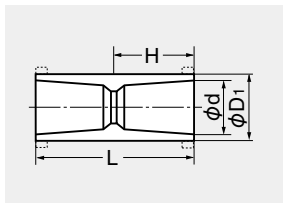

■ Dimensions Table

(Unit: mm)

Size	Product Number	φd	φD	H	L	Package (pcs.)
16	AVT16	22.40	29	33.5	67	130/520
20	AVT20	26.45	33	38.5	77	85/340
25	AVT25	32.55	40	43.5	87	50/200
30	AVT30	38.60	46	47.5	95	35/140
40	AVT40	48.70	57	58.5	117	40/80

Reducing Socket

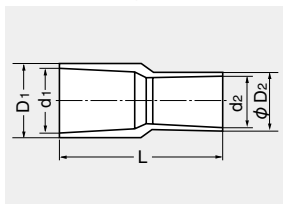

■ Dimensions Table

(Unit: mm)

Size	Product Number	D ₁	d ₁	D ₂	d ₂	L	Package (pcs.)
20×16	AVS20×16	26.45	22.40	33	29	71	100/400
25×20	AVS25×20	32.55	26.45	40	33	84	60/240
30×25	AVS30×25	38.60	32.55	46	40	93	40/160
40×25	AVS40×25	48.70	32.55	57	40	114	50/100
40×30	AVS40×30	48.70	38.60	57	46	114	45/90

Saddle Band (Air-Conditioning Drain Pipe)

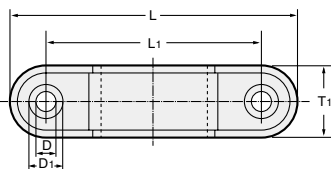
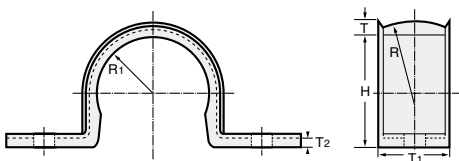

Features

- Ivory White gives harmony with air-conditioning drain pipe.
- No worry for slippage as it is fitted to pipe perfectly.

■ Dimensions Table

(Unit: mm)

Size	T	T ₁	T ₂	R	R ₁	D	D ₁	H	L	L ₁	Quantity (pcs.)
16	1	20	3	25	11	4.5	7.5	21.5	70	50	800
20	3.5	20	3	25	13	4.5	7.5	25.5	76	56	600
25	4	20	3	25	16	5.5	8.5	31.5	88	63	400
32	4	20	3.5	25	19	5.5	8.5	37.4	94	69	400
40	4.5	20	4	25	24	6.5	10.5	47.4	106	81	200

Piping Design Precautions

- Select an appropriate material in consideration of use conditions (fluid type, temperature, pressure, etc.) For details, please consult our nearest office in advance.
- Maximum working pressure is the pressure including the water hammer pressure. Do not use them exceeding the maximum working pressure.
- As maximum working pressure differs by size and temperature, design and use within the allowable range.
- Since they are made from plastic, heat expansion/contraction against temperature change is large compared to metals and heat stress is also generated. Therefore, perform piping support or expansion/construction treatment applicable to the use conditions and installation place.
- In the case of using under the positive-pressure gas, a dangerous condition is expected due to the particular reaction force of compressive fluid even when the value is the same as the water pressure. Therefore, implement a safety measure such as covering pipes with a protection material, etc. to protect the surrounding area before use.
- Do not joint with solvent adhesive or welding connection on differential plastic materials (It may cause damage)

Transportation Precautions

- Do not drag them as it could scratch pipes. Do not drag them as both ends of pipes are easily damaged.

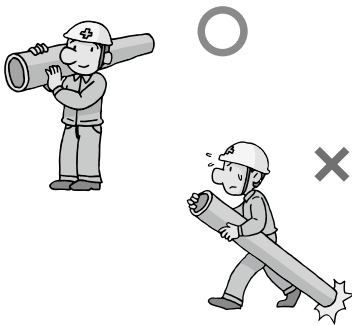

- Two people should handle a pipe with the size of 150 mm or more.

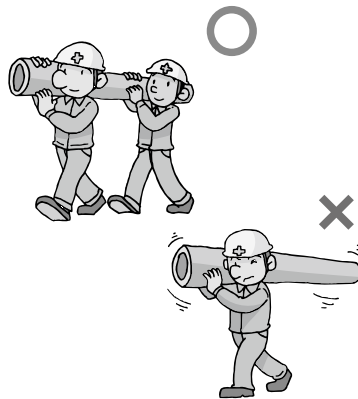

- Do not throw pipes from the truck platform.

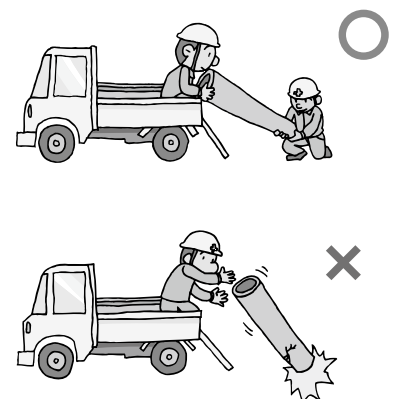

Storage Precautions

- When storing pipes and fittings outside, avoid direct sunlight and implement a measure such as placing a sheet in a way of avoiding heat accumulation.

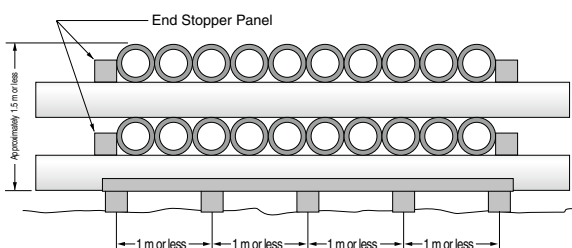

- Do not leave fittings in an enclosed condition (inside a vehicle in Summer, in an enclosed plastic bag, etc.) under a high temperature atmosphere.

Enclosed vehicle
(may deform due to heat)

Packed products in
an sealed condition

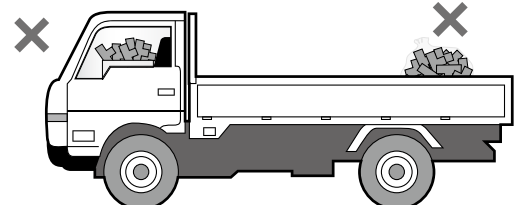

Installation

- Follow our installation procedure to fully exert the work safety and piping performance for installation.
- Make sure to use the specified AV cement for bonding AV PVC pipes.
- Be cautious of excessive adhesive (it may cause solvent cracking and damage).
Caution is needed in low-temperature installation because solvent steam does not evaporate easily and tends to remain (it may cause solvent cracking and damage). During curing after piping, open both ends of pipe without enclosing and remove the solvent steam. During curing, it can be removed more effectively by ventilating inside piping using a ventilator (low-pressure specification) or washing inside piping by filling the water fully after the adhesive is hardened.
- Make sure to perform a completion inspection under water pressure. Do not perform an airtightness test by using air (compressed air or positive-pressure gas) as it is extremely dangerous.

Solvent Cracking (SC) Measure

SC (Solvent Cracking) is a type of stress cracking and specifically distinguished from the cracking phenomenon that occurs when solvent gives an impact inside PVC pipe. SC is caused by the existence of solvent (adhesive, preservative, etc.) It tends to occur more easily due to stress (heat stress, stress of TS connection part, bending, other external stress) and installation during low-temperature like in Winter (solvent tends to remain). When piping, implement a SC measure as explained as follows.

Item	Measure
Adhesive Usage	Apply adhesive compatible to the type of pipe thinly and evenly. Do not apply adhesive extending out from the insertion length on the pipe outer face. In particular, apply thinly and evenly to the inner face of fitting. The reference ratio of adhesive application is 7 to 3 for pipe and fitting.
Wiping of Adhesive	After bonding, make sure to wipe off the protruded adhesive with a cloth after inserting. During application, remove the adhesive spilled on the groove floor.
Opening of pipe on both ends	Fully open valve, air valve, blind flange, etc. for better ventilation and remove the solvent stream (do not enclose).
Utilization of Prefab Method	Prefabricate 2 to 4 pipes in advance, remove the solvent steam by natural ventilation and then connect the pipes.
Ventilation inside Piping	During curing after piping, open both ends of pipe without enclosing and remove the solvent steam (do not enclose). During curing, the steam can be removed more effectively by ventilating inside piping using a ventilator (low-pressure specification).
Washing inside Piping	During curing after piping, open both ends of pipe without enclosing and remove the solvent steam. It is more effective if you fill water all the way and wash after the adhesive is hardened (do not apply the water pressure at this time). Immediately perform this after leaving 30 minutes for the size of 50 mm or less and approximately 1 hour for the size of 65 mm or more.
Expansion Measure	Implement an expansion/contraction treatment to prevent the heat stress from rising due to temperature differences.
Support	When fixing piping, try to avoid using U-bolts as much as possible and use fixation bands with a wider width. In the case of using U-bolts, provide a cushion such as rubber to prevent piping from touching U-bolts. Be fully cautious not to tighten the fixation bands and U-bolts too much.

Adhesive Usage

Do not apply adhesive extending out from the gauge line.

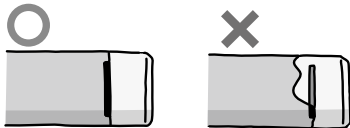

Apply thinly and evenly to the inner face of TS fitting gasket.

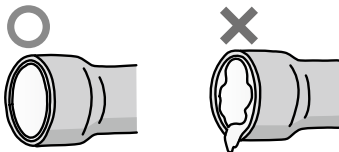

Wiping of Adhesive

Wipe off the protruded adhesive with a cloth after inserting.

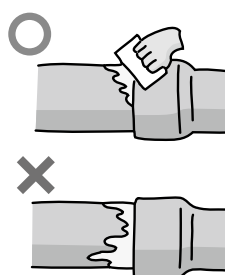

Support

Be cautious not to tighten saddle bands, U-bolts and U-bands too much.

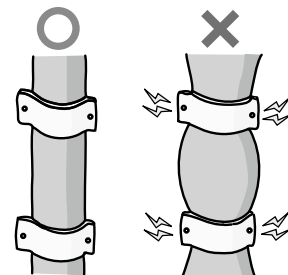

Expansion Measure

Provide expansion/contraction treatment to lower the heat stress.

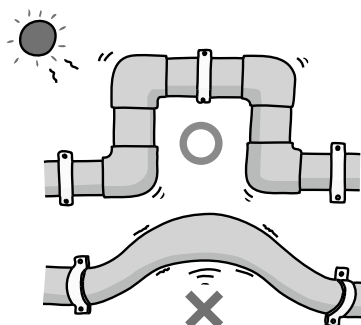

Removal of Solvent and Opening of Pipe on Both Ends

Ventilation

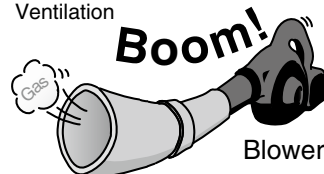

Washing with water



Opening of pipe on both ends

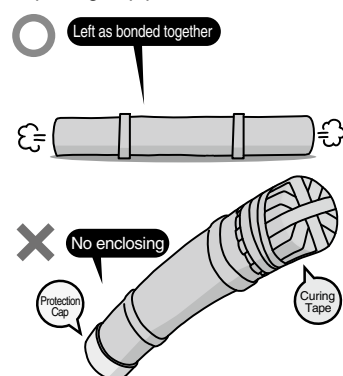

ASAHI AV



Be sure to read the following description of our product warranty

- Always observe the specifications of and the precautions and instructions on using our product.
- We always strive to improve the quality and reliability, but cannot guarantee perfection. Therefore, should you intend to use this product with any equipment or machinery that may pose the risk of serious or even fatal injury, or property damage, ensure an appropriate safety design or take other measures with sufficient consideration given to possible problems. We shall assume no responsibility for any inconvenience stemming from any action on your part without our written consent in the form of specifications or other documented approval.
- The related technical documents, operation manuals, and/or other documentation prescribe precautions on selecting, constructing, installing, operating, maintaining, and servicing our products. For details, consult with our nearest distributor or agent.
- Our product warranty extends for one and a half years after the product is shipped from our factory or one year after the product is installed, whichever comes first. Any product abnormality that occurs during the warranty period or which is reported to us will be investigated immediately to identify its cause. Should our product be deemed defective, we shall assume the responsibility to repair or replace it free of charge.
- Any repair or replacement needed after the warranty period ends shall be charged to the customer.
- The warranty does not cover the following inconveniences by:
 - (1) Using our product under any condition not covered by our defined scope of warranty.
 - (2) Failure to observe our defined precautions or instructions regarding the construction, installation, handling, maintenance, or servicing of our product.
 - (3) Any product other than ours.
 - (4) Remodeling, or otherwise modifying our product by anyone other than us.
 - (5) Using any part of our product for anything other than the intended use of the product.

In no event shall we be responsible or liable for any special, indirect, incidental or consequential damages arising in any way in connection with any products.

[Precautions]

- * Our product warranty shall not apply in case of using a positive-pressure gas with our plastic piping. Using a positive-pressure gas with our plastic piping may pose a dangerous condition due to the repellent force peculiar to compressed fluids, even when the gas is under the same pressure as water. Therefore, be sure to take the necessary safety precautions such as covering the piping with protective material. For inquiries, please contact us.
For conducting a leak test on newly installed piping, be sure to check for leaks under water pressure.
- * Wrap the threaded joints on our plastic piping with sealing tape.
- * Using a liquid sealing agent or liquid gasket may cause stress cracks (environmental stress cracking). Our product warranty shall not apply in case of said use, even when said use is unavoidable.

Export Control

In an effort to remain compliant with international agreements on security, many countries have instituted export controls for advanced goods and technologies which may be used for the proliferation of weapons of mass destruction.

Even in Japan we are sanctioned by the International Export Control Regime and the Chemical Weapons Convention to meet current regulations at home and in countries where we sell our goods and technologies.

In meeting this social and legal obligation, we are asking for your cooperation in providing us information relating to the intended use of our products. Information such as copies of agreements, company organization chart and affidavits of end-use may be required for export permission.

Your cooperation in this endeavor is greatly appreciated and our sales or Asahi distributor people are committed to working with you to continue to provide the best products and services Asahi has to offer.

Global Network

JAPAN

ASAHI YUKIZAI CORPORATION. OVERSEAS DEPARTMENT.
20th Floor, World Trade Center Bldg, 4-1 Hamamatsu-Cho 2-Chome,
Minato-Ku, Tokyo, Japan 105-6120
TEL: +81-3-3578-6015 FAX: +81-3-3578-6025

THAILAND

ASAHI YUKIZAI CORPORATION. BANGKOK REPRESENTATIVE OFFICE.
323 United Center Building, Unit 3004B, 30th Floor, Silom Road, Silom,
Bangrak, Bangkok 10500 THAILAND
TEL: +662-631-1100 FAX: +662-631-1103

KOREA

ASAHI KOREA CO.,LTD [Subsidiary]
#805-D Digitaempire office, 16, Deogyong-daero
1556beon-gil, Yeongtong-dong, Yeongtong-gu, Suwon-si, Gyeonggi-do, Korea
TEL: +82-31-203-2050 FAX: +82-31-203-2880

SINGAPORE

ASAHI ASIA PACIFIC PTE.LTD. [Subsidiary]
207 Woodlands Avenue 9, #06-55, Singapore 738958
TEL: +65-6755-8033 FAX: +65-6754-7033

CHINA

ASAHI ORGANIC CHEMICALS TRADING (SHANGHAI) CO.,LTD.
[Subsidiary]
Rm 405, East Tower, Sun Plaza NO.88 Xianxia Road, Changning District,
Shanghai, China 200336
TEL: +86-21-6278-7862 FAX: +86-21-6278-7892

ASAHI AV VALVE (SHANGHAI) CO., LTD. [Subsidiary]
No.16, Shanghai Malu Fengdeng Industry City, 615 Fengdeng Road,
Malu Town, Jiading District, Shanghai 201818, PRC
TEL: +86-21-6139-2600 FAX: +86-21-6139-2606

GERMANY

ASAHI AV EUROPE GmbH [Subsidiary]
Kaiser-Friedrich-Promenade 61 D-61348 Bad Homburg Germany
TEL: +49-6172-9175-0 FAX: +49-6172-9175-25

USA

ASAHI/AMERICA,INC [Subsidiary]
655 Andover, St.Lawrence, MA 01843 USA
TEL: +1-781-321-5409 FAX: +1-978-685-3010

See our Products website.

<http://asahiav.jp/en/>

ASAHIIV Japan

Search



- Latest News
- Download Catalogs (PDF)
- Download Chemical Resistance Sheet
- Download Installation Operation & Maintenance Manual
- Download drawings (CAD, Outline Dimensional Drawings)



Distributor:

SDT TECHNOLOGY DEVELOPMENT SUPPORT CO., LTD.

Hanoi office: 2nd Floor, GREEN OFFICE, MECO Complex,
102 Truong Chinh str., Dong Da Dist., Hanoi

Warehouse: Kho F, Trung Tam Dich Vu Co Dien, km12,
Ngoc Hoi str., Thanh Tri Dist., Hanoi

Tel/Fax: (+84 24) 3792 1548 / 3792 1549

Ho Chi Minh City: A27 bis, To Ky str., Trung My Tay Ward,
District 12, Ho Chi Minh City

Tel/Fax: (+84 28) 3620 0949 / 3620 0948

Website: www.sdt.com.vn; Email: support@sdt.com.vn

Hotline: (+84) 093 2324 036